

MOTOPLASTIC, S.A.

Molí de la sal, 1 - 08400 Granollers (Barcelona) SPAIN

Tel. 34 93 849 06 33 - Fax 34 93 849 09 88

info@puig.tv - info@puigusa.com





www.puig.tv - www.puigusa.com

INSTRUCCIONES DE MONTAJE - MOUNTING INSTRUCTIONS

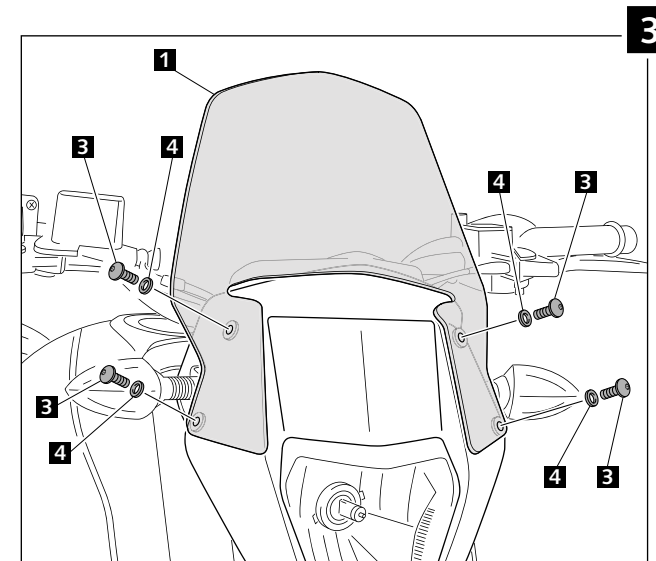
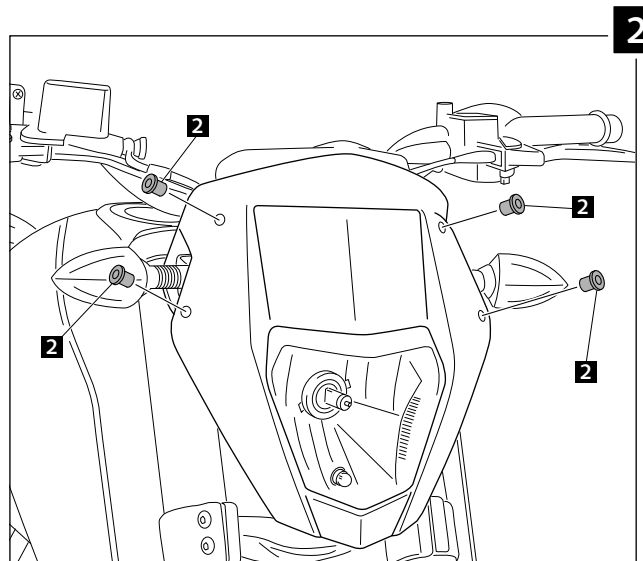
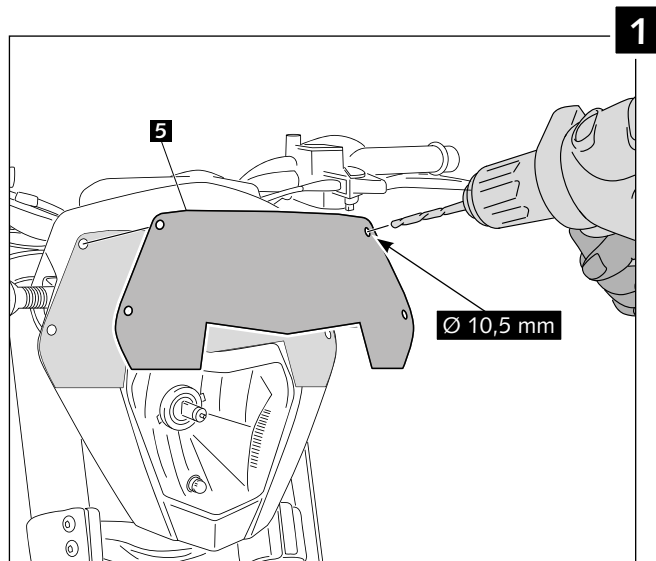
CARENABRÍ ADAPTABLE A - WINDSHIELD ADAPTABLE TO KTM DUKE 690 '12 - '19

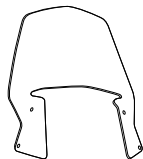
Ref.: 6009



ID.	DESCRIPCIÓN	DESCRIPTION	QTY.
1	 Pantalla	Screen	1
2	 Tuerca M5 silemblock	M5 nut well nut	4
3	 Tornillo allen M5x16 ISO 7380	M5x16 ISO 7380 allen screw	4
4	 Arandela nylon Ø5XØ11x1	Ø5XØ11x1 nylon washer	4
5	 Plantilla	Template	1