

**Puig**  
*Hi-Tech Parts*

**2024**

*Our passion from within*









We start 2024 by boosting digitalization, announcing our new website that will allow you to navigate by motorcycle type, allowing you to find products in an easier and more intuitive way. Likewise, B2B receives improvements in design and new functionalities.

In reference to digital communication, generating greater visual and multimedia content both at the explanatory level of the product and at the level of social networks. Faithful to the technical collaboration in **MOTO GP** and **SUPERBIKES** in the **HRC (MOTO GP)** and **KRT (SUPERBIKES)** teams, testing new materials, shapes and designs that are already being applied to the products in this new catalogue. From here, we support both teams with all our technology so that they give us a new world crown to add to our record.

We want to highlight the following **2024 news** that you can find in the catalogue:

- **Upper front area:** Fury semi-fairing (page 136), Dashboard Protector (page 154).
- **Handlebar area:** Pullback risers (page 162), Bond rearview mirror (page 208), Hi-Tech V rearview mirror (page 210), Z3 rearview mirror (page 240), Rearview mirror thread trim cap (page 244), Covers mirrors with turn signals (page 250).
- **Tank area:** Challenge tank protector (page 294), Grasp tank protector (page 299).
- **Intermediate front zone:** Hi-Beam 3.0 auxiliary lights (p. 336), Dart turn signal (p. 346), Tab turn signal (p. 346), Rugged turn signal (p. 345).
- **Chassis-engine area:** Exhaust protector (page 384).
- **Wheel area:** Performance strips (page 460).

Once again we appreciate the trust you place in the brand, a reason that encourages us to continue pushing to keep this catalog up to date, year after year.





# TIMELINE

**Workforce:** 3 Workers

**Infrastructures:** 100m<sup>2</sup> - 1 Location

**Main Product:** Touring Fairing

**Technology:** Fiberglass - Manual processes

**Countries where it is sold:** Spain

## 1964

### Company Foundation: "PUIG FAIRINGS"

In the garage of their house in Granollers, Spain, the brothers Josep and Jaume Puig founded the company "Carenados Puig" as a result of their motorcycle passion, only 100m<sup>2</sup> that saw the birth of a dream, making motorcycle fairings.

The two founders were Derbi workers, and they materialized their dreams by turning their passion into their work.

On the left of the image we see Josep Puig, who is in charge of the commercial part of the company, and on the right Jaume Puig, responsible for the technical part and the design of the pieces.

Photographed on a competition Montesa 250cc with Puig fairing and screen in Granollers, very close to where the company's headquarters are currently located.



"LEG SHIELD"  
for DERBI 49CC

### PRODUCTION PHASES

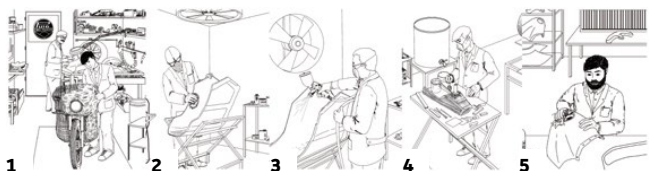

## 1967

### New products

TOURING FAIRING for DERBI 49CC

"LEG SHIELD" for DERBI 49CC

### PRODUCTION PHASES

1. Design and prototypes
2. Molds
3. Paint the mold with gelcoat
4. Layering of Polyester fiber
5. Demould and polish --- Finished part

## 1980

### EXPANSION OF THE FACILITIES WITH THE NEW SECTION OF POLITÉ SHEET BLOW MOLDING AND LAMINATING

A new blow molding section is commissioned to serve the Puch of Gijón brand and the sheet extrusion machine is used to produce the thermoformed semi-fairings and windshields for the Derbi and Vespa.

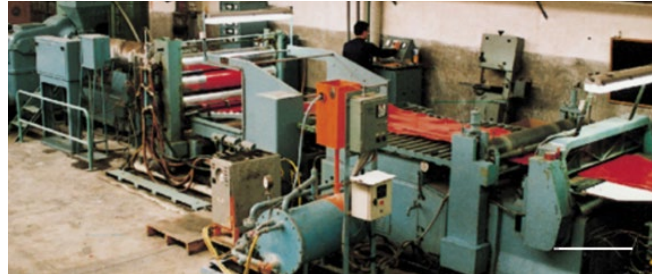

EUROPA II FAIRING  
for the Yamaha XJ650



M6 trunk  
made of plastic



Fuel tank for  
Montesa Cross-Enduro

## 1985

### THE RANGE OF PRODUCTS IS EXPANDED

The new blow-moulding machinery allows closed shapes to be created that are empty on the inside, and that in turn to be able to manufacture tanks and boxes for transporting objects.

Europa II Fairings are designed and built for the Yamaha XS400 and XJ650. These were the first complete fairings to incorporate aerodynamic protection for the rider's legs, arms and torso, thanks to the wraparound fiber part and the large screen.

## 1996

### NUMERICAL CONTROL INCORPORATION

First 5-Axis robot.

The manufacture of polyester fiber is a very traditional process that does not allow meeting the growing demand and it is decided to promote thermoforming and pressing. More industrial processes to be able to manufacture more standardized parts and meet demand.

The production of fairings in polyester fiber is abandoned, and focuses on the design and manufacture of screens in acrylic material.

1. TG WINDSHIELD
2. CUSTOM SCREEN
3. NAKED WINDSHIELD
4. SEMIFAIRING CITY
5. CARGO BOX FOR MOTORCYCLE MADE OF PLASTIC



1



2



3



4



5





## 2000-2004

### THE ORIGINAL REPLICA, TOURING AND DOUBLE BUBBLE SCREEN LINE OF PRODUCTION BEGINS AND MOVE TO A NEW WAREHOUSE

Puig also begins the manufacture of screens for motorcycles with original windshield. Puig screens are designed with small changes compared to the originals, in order to provide more style, protection, aggressiveness...

The design and production section moves to the new headquarters in the Can Castells Industrial area in Canovelles, Spain, the 1000 square meter warehouse is adjacent to the blow molding section.



ORIGINAL REPLICA SCREEN



DOUBLE BUBBLE RACING SCREEN



TOURING SCREEN



Image of the front view of Barcelona street.



## 2009-2023

### WORKING WITH THE BEST TEAMS

Puig strongly commits to being with the best riders and teams, a strategy that rewards the catalan manufacturer by winning several world championships and from which a lot of Know-How is acquired thanks to working with top professionals in the industry.

## 2012

### EXPANSION TO THE USA – PUIG USA Inc

New distribution warehouse.

With the firm desire to open Puig brand to the American and South American markets by offering great service and competitive delivery times, a new headquarters is opened in Orlando (Florida) from where Puig products can be shipped to these markets.



Image of the front view of the Puig USA warehouse in Orlando.



Remodeling of the Puig headquarters in Granollers.

## 2015

### IMPLEMENTATION OF PICKING OPERATIONS

Through automated vertical warehouses.



## 2017

### PRODUCTION LINE AUTOMATION

Incorporation of the latest technology, Nesting1.



## 2020

### AUTO THERMOFORMING PROCESS

Incorporation of a fully automated thermoforming machine.



## 2023

### EXPANSION OF THE PRODUCTION LINE

Beginning of the second production line, Nesting2.

Our packaging is produced in 100% recyclable plastic material.



LDPE

100% RECYCLED MATERIAL

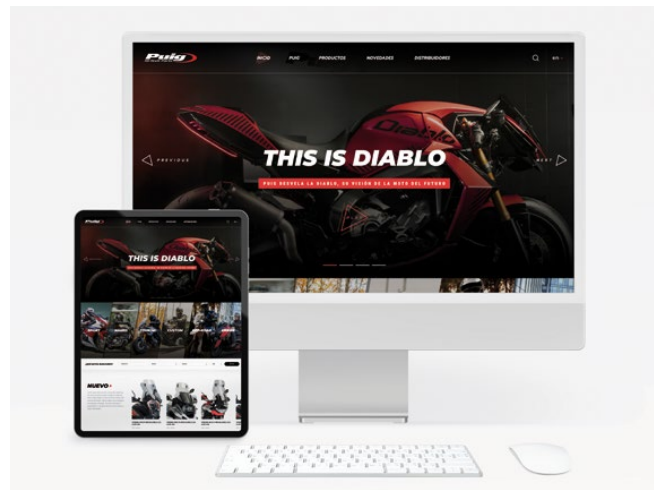

## 2024

### WEBSITE AND B2B UPDATE

Improvements in both tools to adapt them to new technologies.

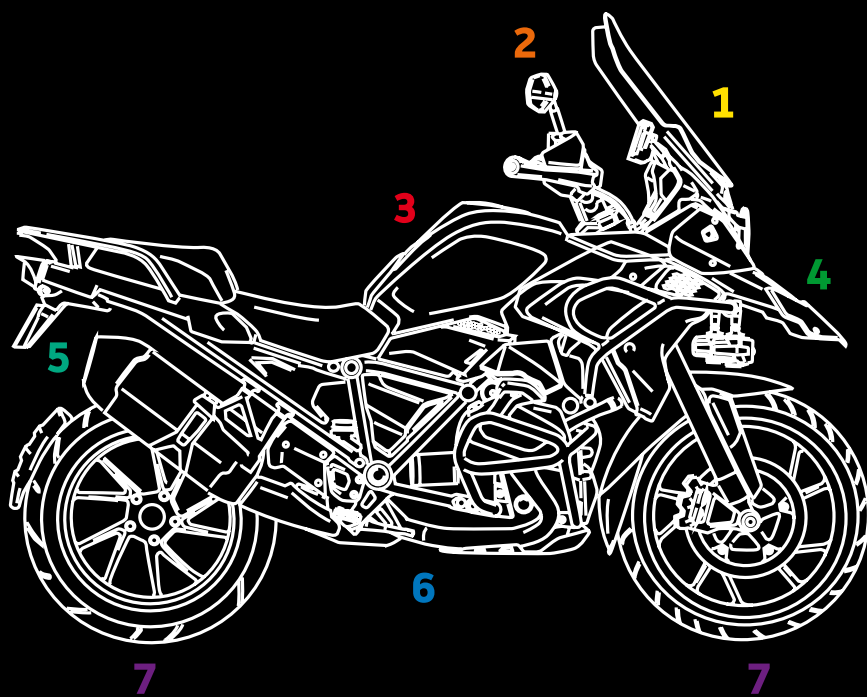

# INDEX

**10**

**35**

**50**

**156**

**272**

**318**

**370**

**388**

**436**

**472**

**481**

**484**

**494**



---

FULLY EQUIPPED MOTORCYCLES

---

RACING

---

**1.** SUPERIOR FRONT AREA

---

**2.** HANDLEBAR AREA

---

**3.** GAS TANK AREA

---

**4.** MIDDLE FRONT AREA

---

**5.** REAR AREA

---

**6.** CHASSIS-ENGINE AREA

---

**7.** WHEELS AREA

---

MAINTENANCE / WORKSHOP

---

WINTER

---

DELIVERY

---

MERCHANDISING

---

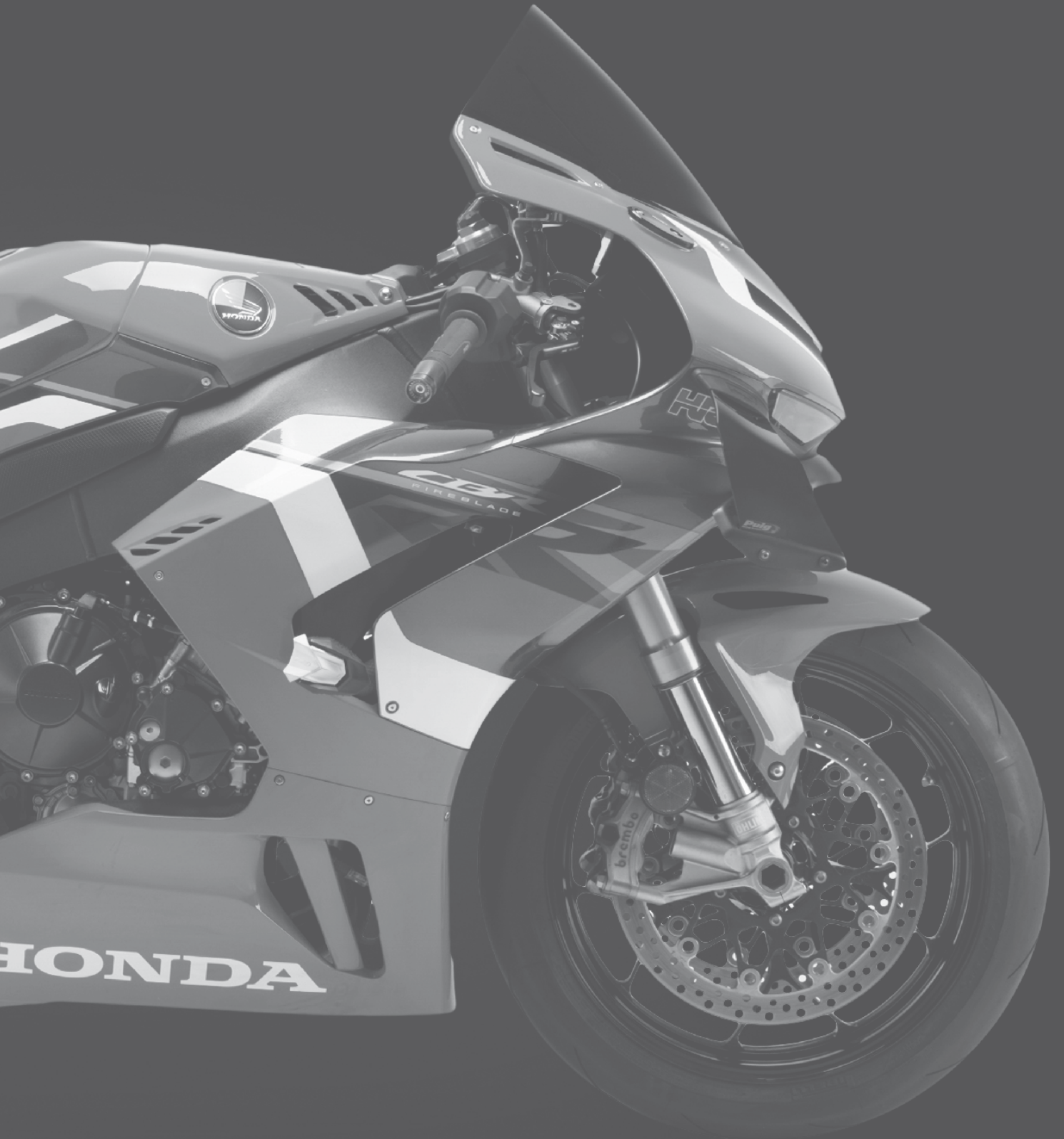

HONDA

# FULLY EQUIPPED MOTORCYCLES

<b>APRILIA</b> TUAREG 660	<b>12</b>
<b>BENELLI</b> TRK 502 X	<b>13</b>
<b>BMW</b> F900R	<b>14</b>
<b>BMW</b> R1250GS	<b>15</b>
<b>DUCATI</b> MONSTER 937	<b>16</b>
<b>HONDA</b> CB650R NEO SPORTS CAFÉ	<b>17</b>
<b>HONDA</b> CB750 HORNET	<b>18</b>
<b>HONDA</b> CBR1000RR-R	<b>19</b>
<b>HONDA</b> FORZA 125	<b>20</b>
<b>HONDA</b> FORZA 750	<b>21</b>
<b>HONDA</b> PCX 125	<b>22</b>
<b>HONDA</b> SH 125I	<b>23</b>
<b>HONDA</b> X-ADV	<b>24</b>
<b>KAWASAKI</b> Z650	<b>25</b>
<b>KAWASAKI</b> Z900	<b>26</b>
<b>KAWASAKI</b> Z900RS SE	<b>27</b>
<b>KAWASAKI</b> ZX-10R	<b>28</b>
<b>KTM</b> 890 DUKE	<b>29</b>
<b>SUZUKI</b> GSX-8S	<b>30</b>
<b>YAMAHA</b> MT-07	<b>31</b>
<b>YAMAHA</b> MT-09	<b>32</b>
<b>YAMAHA</b> TENERE 700	<b>33</b>
<b>YAMAHA</b> TRACER 7	<b>34</b>

**APRILIA**

# TUAREG 660



<b>1</b>	TOURING SCREEN WITH VISOR	<b>64</b>
<b>2</b>	AXLE SLIDERS PHB19	<b>452</b>
<b>3</b>	AXLE SLIDERS PHB19	<b>452</b>
<b>4</b>	ENDURO FOOTPEGS 2.0	<b>398</b>
<b>5</b>	SPORT FOOTPEGS	<b>396</b>
<b>6</b>	REARVIEW MIRROR TOP-TECH I	<b>226</b>
<b>7</b>	SPOOL PRO	<b>406</b>

**BENELLI**

# TRK 502 X



<b>1</b>	TOURING WINDSHIELD	<b>60</b>
<b>2</b>	EXTENDED FRONT DEFLECTORS	<b>93</b>
<b>3</b>	REARVIEW MIRROR TOP-TECH I	<b>226</b>
<b>4</b>	SPOOL PRO	<b>406</b>
<b>5</b>	TANK SIDE PROTECTORS ANTI-SLIP	<b>292</b>



**BMW**

# F900R



<b>1</b>	WINDSHIELD NEW GENERATION SPORT	<b>96</b>
<b>2</b>	REAR FENDERS	<b>440</b>
<b>3</b>	FRAME SLIDERS R19 MODEL	<b>420</b>
<b>4</b>	AXLE SLIDERS PHB19	<b>452</b>
<b>5</b>	AXLE SLIDERS PHB19	<b>452</b>
<b>6</b>	LEVERS 3.0	<b>166</b>
<b>7</b>	BRAKE / CLUTCH LEVER PROTECTOR	<b>172</b>
<b>8</b>	R-FIGHTER FOOTPEGS	<b>394</b>
<b>9</b>	R-FIGHTER S FOOTPEGS	<b>394</b>

<b>10</b>	REARVIEW MIRROR Z2	<b>242</b>
-----------	--------------------	------------

**BMW**

# R1250GS



<b>1</b>	TOURING WINDSHIELD	<b>60</b>
<b>2</b>	E.R.S. (ELECTRONIC REGULATION SYSTEM)	<b>78</b>
<b>3</b>	HANDGUARD EXTENSIONS	<b>254</b>
<b>4</b>	FRONT FENDER EXTENSION	<b>450</b>
<b>5</b>	SIDE PANELS	<b>432</b>
<b>6</b>	CHASSIS CAP COVERS	<b>430</b>
<b>7</b>	REAR DEFLECTORS	<b>434</b>
<b>8</b>	LOWER DEFLECTORS	<b>324</b>
<b>9</b>	AXLE SLIDERS PHB19	<b>452</b>

<b>10</b>	ENGINE GUARDS	<b>424</b>
<b>11</b>	ENDURO FOOTPEGS 2.0	<b>398</b>
<b>12</b>	SPORT FOOTPEGS	<b>396</b>
<b>13</b>	REARVIEW MIRROR GT.1	<b>234</b>
<b>14</b>	PLUG-OIL CAPS TRACK	<b>404</b>

**DUCATI**

# MONSTER 937



<b>1</b>	WINDSHIELD NEW GENERATION SPORT	<b>96</b>
<b>2</b>	ENGINE SPOILERSS	<b>416</b>
<b>3</b>	FRAME SLIDERS R19 MODEL	<b>420</b>
<b>4</b>	AXLE SLIDERS PHB19	<b>452</b>
<b>5</b>	AXLE SLIDERS PHB19	<b>452</b>
<b>6</b>	LICENSE SUPPORTS	<b>374</b>
<b>7</b>	HI-BEAM 2.0 AUXILIARY LIGHTS	<b>338</b>
<b>8</b>	LEVERS 3.0	<b>166</b>
<b>9</b>	R-FIGHTER FOOTPEGS	<b>394</b>

<b>10</b>	REARVIEW MIRROR TRACKER	<b>218</b>
-----------	-------------------------	------------



**HONDA**

# CB650R NEO SPORTS CAFÉ



<b>1</b>	WINDSHIELD NEW GENERATION SPORT	<b>96</b>
<b>2</b>	ENGINE SPOILERSS	<b>416</b>
<b>3</b>	FRAME SLIDERS R19 MODEL	<b>420</b>
<b>4</b>	AXLE SLIDERS PHB19	<b>452</b>
<b>5</b>	LICENSE SUPPORTS	<b>374</b>
<b>6</b>	LEVERS 3.0	<b>166</b>
<b>7</b>	SPORT FOOTPEGS	<b>396</b>
<b>8</b>	BAR ENDS SPEED	<b>198</b>
<b>9</b>	REARVIEW MIRROR TOP-TECH I	<b>226</b>

**HONDA**

# CB750 HORNET



<b>1</b>	WINDSHIELD NEW GENERATION SPORT	<b>96</b>
<b>2</b>	REAR FENDERS	<b>440</b>
<b>3</b>	ENGINE SPOILERS	<b>416</b>
<b>4</b>	DOWNFORCE SPOILERS NAKED	<b>46</b>
<b>5</b>	FRONTAL SPOILER NAKED	<b>48</b>
<b>6</b>	FRAME SLIDERS R19 MODEL	<b>420</b>
<b>7</b>	LEVERS 3.0	<b>166</b>
<b>8</b>	BRAKE / CLUTCH LEVER PROTECTOR	<b>172</b>
<b>9</b>	R-FIGHTER FOOTPEGS	<b>394</b>

<b>10</b>	SPORT FOOTPEGS	<b>396</b>
<b>11</b>	REARVIEW MIRROR GT.1	<b>234</b>

**HONDA**

# CBR1000RR-R

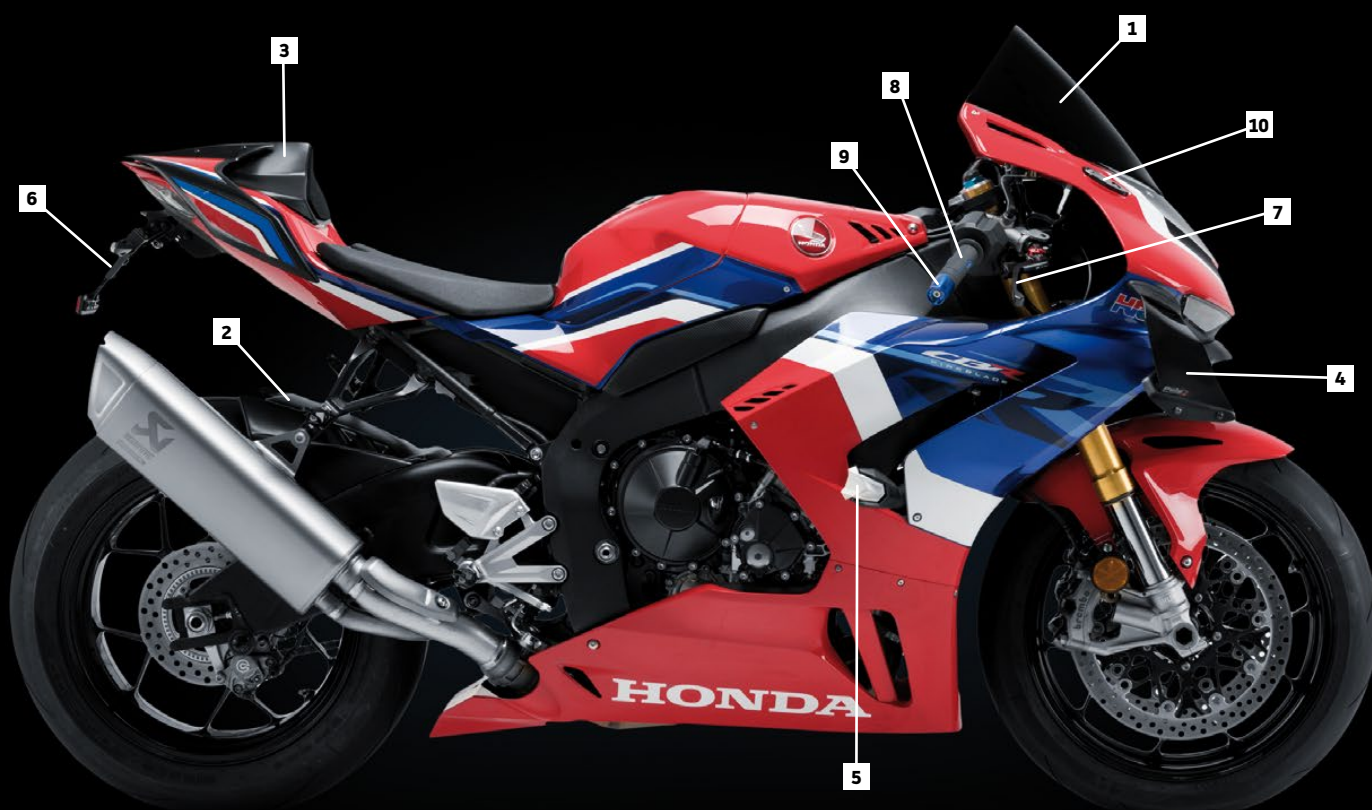

<b>1</b>	R-RACER WINDSCREEN	<b>54</b>
<b>2</b>	REAR FENDERS	<b>440</b>
<b>3</b>	REAR SEAT COWLS	<b>372</b>
<b>4</b>	FRONTAL SPOILER GP	<b>44</b>
<b>5</b>	FRAME SLIDERS R19 MODEL	<b>420</b>
<b>6</b>	LICENSE SUPPORTS	<b>374</b>
<b>7</b>	LEVERS 3.0	<b>166</b>
<b>8</b>	CORE GRIPS	<b>192</b>
<b>9</b>	BAR ENDS SPORT MODEL	<b>196</b>

<b>10</b>	REARVIEW MIRROR CAPS	<b>248</b>
-----------	----------------------	------------



# HONDA FORZA 125



<b>1</b>	V-TECH LINE TOURING	<b>80</b>
<b>2</b>	LEVERS 3.0	<b>166</b>
<b>3</b>	BAR ENDS SHORT	<b>198</b>



**HONDA**

# FORZA 750



<b>1</b>	V-TECH LINE TOURING	<b>80</b>
<b>2</b>	REAR FENDERS	<b>440</b>
<b>3</b>	AXLE SLIDERS PHB19	<b>452</b>
<b>4</b>	AXLE SLIDERS PHB19	<b>452</b>
<b>5</b>	LEVERS 3.0	<b>166</b>
<b>6</b>	RACING FOOTPEGS	<b>396</b>
<b>7</b>	CORE GRIPS	<b>192</b>
<b>8</b>	BAR ENDS SPEED	<b>198</b>
<b>9</b>	REARVIEW MIRROR GT.1	<b>234</b>

<b>10</b>	MOBILE SUPPORTS	<b>264</b>
-----------	-----------------	------------



# HONDA PCX 125



<b>1</b>	V-TECH LINE TOURING	<b>80</b>
<b>2</b>	MAXISCOOTER HANDGUARDS	<b>256</b>
<b>3</b>	TRUNK INSTALLATION KIT	<b>492</b>
<b>4</b>	MAXI BOX TOP BOX	<b>488</b>

**HONDA**

# SH 125i



<b>1</b>	WINDSHIELD T.X.	<b>152</b>
<b>2</b>	GAUNTLETS FOR T.X.	<b>153</b>
<b>3</b>	SCOOTER LEVERS	<b>174</b>
<b>4</b>	BAR ENDS LONG	<b>198</b>
<b>5</b>	SPECIAL RIM STRIPS	<b>462</b>
<b>6</b>	TRUNK INSTALLATION KIT	<b>492</b>
<b>7</b>	MAXI BOX TOP BOX	<b>488</b>



# HONDA X-ADV



<b>1</b>	TOURING WINDSHIELD	<b>60</b>
<b>2</b>	REAR FENDERS	<b>440</b>
<b>3</b>	AXLE SLIDERS PHB19	<b>452</b>
<b>4</b>	AXLE SLIDERS PHB19	<b>452</b>
<b>5</b>	LICENSE SUPPORTS	<b>374</b>
<b>6</b>	ENDURO FOOTPEGS 2.0	<b>398</b>
<b>7</b>	REARVIEW MIRROR HYPERNAKED	<b>230</b>





# KAWASAKI Z650



<b>1</b>	WINDSHIELD NEW GENERATION SPORT	<b>96</b>
<b>2</b>	ENGINE SPOILERSS	<b>416</b>
<b>3</b>	DOWNFORCE SPOILERS NAKED	<b>46</b>
<b>4</b>	FRAME SLIDERS R19 MODEL	<b>420</b>
<b>5</b>	AXLE SLIDERS PHB19	<b>452</b>
<b>6</b>	LICENSE SUPPORTS	<b>374</b>
<b>7</b>	LEVERS 3.0	<b>166</b>
<b>8</b>	R-FIGHTER FOOTPEGS	<b>394</b>
<b>9</b>	ASCENT GRIPS	<b>186</b>

<b>10</b>	BAR ENDS THRUSTER	<b>202</b>
<b>11</b>	REARVIEW MIRROR F1.1	<b>238</b>
<b>12</b>	MOBILE CASE	<b>262</b>
<b>13</b>	BRAKE-CLUTCH LIQUID TANK COVER	<b>180</b>
<b>14</b>	SPOOL PRO	<b>406</b>
<b>15</b>	PLUG-OIL CAPS TRACK	<b>404</b>



# KAWASAKI Z900



<b>1</b>	WINDSHIELD NEW GENERATION SPORT	<b>96</b>
<b>2</b>	ENGINE SPOILERSS	<b>416</b>
<b>3</b>	DOWNFORCE SPOILERS NAKED	<b>46</b>
<b>4</b>	FRONTAL SPOILER NAKED	<b>48</b>
<b>5</b>	FRAME SLIDERS R19 MODEL	<b>420</b>
<b>6</b>	AXLE SLIDERS PHB19	<b>452</b>
<b>7</b>	LICENSE SUPPORTS	<b>374</b>
<b>8</b>	HI-BEAM 2.0 AUXILIARY LIGHTS	<b>338</b>
<b>9</b>	BRAKE / CLUTCH LEVER PROTECTOR	<b>172</b>

<b>10</b>	RACING FOOTPEGS	<b>396</b>
<b>11</b>	ASCENT GRIPS	<b>186</b>
<b>12</b>	REARVIEW MIRROR HYPERNAKED	<b>230</b>
<b>13</b>	SPOOL PRO	<b>406</b>
<b>14</b>	PLUG-OIL CAPS TRACK	<b>404</b>
<b>15</b>	TURN SIGNAL COVERS	<b>342</b>

**KAWASAKI**

# Z900RS SE



<b>1</b>	RETRO SEMI FAIRING	<b>126</b>
<b>2</b>	VINTAGE 2.0 FRAME SLIDERS	<b>422</b>
<b>3</b>	AXLE SLIDERS PHB19	<b>452</b>
<b>4</b>	LICENSE SUPPORTS	<b>374</b>
<b>5</b>	LEVERS 3.0	<b>166</b>
<b>6</b>	HERITAGE FOOTPEGS	<b>402</b>
<b>7</b>	SPORT FOOTPEGS	<b>396</b>
<b>8</b>	RADIKAL GRIPS	<b>188</b>
<b>9</b>	REARVIEW MIRROR GRAND TRACKER	<b>216</b>

<b>10</b>	BRAKE-CLUTCH LIQUID TANK COVER	<b>180</b>
<b>11</b>	SPOOL PRO	<b>406</b>
<b>12</b>	PLUG-OIL CAPS TRACK	<b>404</b>





# KAWASAKI ZX-10R



<b>1</b>	Z-RACING WINDSCREEN	<b>52</b>
<b>2</b>	DOWNFORCE SPOILERS RACE	<b>42</b>
<b>3</b>	FRAME SLIDERS PRO 2.0	<b>418</b>
<b>4</b>	LICENSE SUPPORTS	<b>374</b>
<b>5</b>	LEVERS 3.0	<b>166</b>
<b>6</b>	RACING FOOTPEGS	<b>396</b>
<b>7</b>	BAR ENDS SPEED	<b>198</b>
<b>8</b>	REARVIEW MIRROR Z2	<b>242</b>
<b>9</b>	SPOOL PRO	<b>406</b>

**KTM**

# 890 DUKE



<b>1</b>	WINDSHIELD NEW GENERATION SPORT	<b>96</b>
<b>2</b>	ENGINE SPOILERSS	<b>416</b>
<b>3</b>	FRAME SLIDERS R19 MODEL	<b>420</b>
<b>4</b>	AXLE SLIDERS PHB19	<b>452</b>
<b>5</b>	AXLE SLIDERS PHB19	<b>452</b>
<b>6</b>	LICENSE SUPPORTS	<b>374</b>
<b>7</b>	HI-BEAM 2.0 AUXILIARY LIGHTS	<b>338</b>
<b>8</b>	LEVERS 3.0	<b>166</b>
<b>9</b>	BRAKE / CLUTCH LEVER PROTECTOR	<b>172</b>

<b>10</b>	REARVIEW MIRROR HYPERNAKED	<b>230</b>
<b>11</b>	PLUG-OIL CAPS TRACK	<b>404</b>



# SUZUKI GSX-8S



<b>1</b>	WINDSHIELD NEW GENERATION SPORT	<b>96</b>
<b>2</b>	REAR FENDERS	<b>440</b>
<b>3</b>	FRONTAL SPOILER NAKED	<b>48</b>
<b>4</b>	ENGINE PROTECTIVE COVERS	<b>426</b>
<b>5</b>	FRAME SLIDERS R19 MODEL	<b>420</b>
<b>6</b>	HI-BEAM 2.0 AUXILIARY LIGHTS	<b>338</b>
<b>7</b>	AXLE SLIDERS PHB19	<b>452</b>
<b>8</b>	AXLE SLIDERS PHB19	<b>452</b>
<b>9</b>	LICENSE SUPPORTS	<b>374</b>

<b>10</b>	LEVERS 3.0	<b>166</b>
<b>11</b>	BRAKE / CLUTCH LEVER PROTECTOR	<b>172</b>
<b>12</b>	R-FIGHTER FOOTPEGS	<b>394</b>
<b>13</b>	R-FIGHTER S FOOTPEGS	<b>394</b>
<b>14</b>	REARVIEW MIRROR Z3	<b>240</b>
<b>15</b>	BRAKE-CLUTCH LIQUID TANK COVER	<b>180</b>
<b>16</b>	SPOOL PRO	<b>406</b>
<b>17</b>	PLUG-OIL CAPS TRACK	<b>404</b>



**YAMAHA**

# MT-07



<b>1</b>	WINDSHIELD NEW GENERATION SPORT	<b>96</b>
<b>2</b>	REAR FENDERS	<b>440</b>
<b>3</b>	HI-BEAM AUXILIARY LIGHTS	<b>340</b>
<b>4</b>	ENGINE SPOILERS	<b>416</b>
<b>5</b>	FRAME SLIDERS R19 MODEL	<b>420</b>
<b>6</b>	AXLE SLIDERS PHB19	<b>452</b>
<b>7</b>	AXLE SLIDERS PHB19	<b>452</b>
<b>8</b>	LICENSE SUPPORTS	<b>374</b>
<b>9</b>	BRAKE / CLUTCH LEVER PROTECTOR	<b>172</b>

<b>10</b>	R-FIGHTER'S FOOTPEGS	<b>394</b>
<b>11</b>	RACING FOOTPEGS	<b>396</b>
<b>12</b>	REARVIEW MIRROR GTI	<b>236</b>
<b>13</b>	SPECIAL RIM STRIPS	<b>462</b>



YAMAHA

# MT-09



<b>1</b>	WINDSHIELD NEW GENERATION SPORT	<b>96</b>
<b>2</b>	ENGINE SPOILERS	<b>416</b>
<b>3</b>	FRAME SLIDERS R19 MODEL	<b>420</b>
<b>4</b>	AXLE SLIDERS PHB19	<b>452</b>
<b>5</b>	AXLE SLIDERS PHB19	<b>452</b>
<b>6</b>	LICENSE SUPPORTS	<b>374</b>
<b>7</b>	BRAKE / CLUTCH LEVER PROTECTOR	<b>172</b>
<b>8</b>	RACING FOOTPEGS	<b>396</b>
<b>9</b>	RACING GRIPS	<b>190</b>

<b>10</b>	REARVIEW MIRROR GTI	<b>236</b>
<b>11</b>	SPOOL PRO	<b>406</b>
<b>12</b>	PLUG-OIL CAPS TRACK	<b>404</b>



**YAMAHA**

# TENERE 700



<b>1</b>	TOURING WINDSHIELD	<b>60</b>
<b>2</b>	HANDGUARD EXTENSIONS	<b>254</b>
<b>3</b>	BEAK EXTENDER	<b>320</b>
<b>4</b>	EXTENDED FRONT DEFLECTORS	<b>93</b>
<b>5</b>	HEADLIGHT PROTECTOR	<b>326</b>
<b>6</b>	AXLE SLIDERS PHB19	<b>452</b>
<b>7</b>	AXLE SLIDERS PHB19	<b>452</b>
<b>8</b>	LICENSE SUPPORTS	<b>374</b>
<b>9</b>	ENGINE GUARDS	<b>424</b>

<b>10</b>	HI-BEAM 2.0 AUXILIARY LIGHTS	<b>338</b>
<b>11</b>	ENDURO FOOTPEGS 2.0	<b>398</b>
<b>12</b>	R-FIGHTER FOOTPEGS	<b>394</b>
<b>13</b>	REARVIEW MIRROR Z3	<b>240</b>
<b>14</b>	MOBILE SUPPORTS	<b>264</b>



YAMAHA

# TRACER 7



<b>1</b>	SPORT WINDSCREEN	<b>58</b>
<b>2</b>	REAR FENDERS	<b>440</b>
<b>3</b>	REAR BRAKE TANK COVER	<b>386</b>
<b>4</b>	HEADLIGHT PROTECTOR	<b>326</b>
<b>5</b>	AXLE SLIDERS PHB19	<b>452</b>
<b>6</b>	AXLE SLIDERS PHB19	<b>452</b>
<b>7</b>	LICENSE SUPPORTS	<b>374</b>
<b>8</b>	ENGINE GUARDS	<b>424</b>
<b>9</b>	HI-BEAM 2.0 AUXILIARY LIGHTS	<b>338</b>

<b>10</b>	LEVERS 3.0	<b>166</b>
<b>11</b>	TRAIL 2.0 FOOTPEGS	<b>398</b>
<b>12</b>	R-FIGHTER S FOOTPEGS	<b>394</b>
<b>13</b>	ASCENT GRIPS	<b>186</b>
<b>14</b>	BAR ENDS THRUSTER MODEL	<b>202</b>
<b>15</b>	REARVIEW MIRROR GT.1	<b>234</b>
<b>16</b>	SPOOL PRO	<b>406</b>
<b>17</b>	ADHESIVE TANK PADS SET	<b>290</b>
<b>18</b>	SPECIAL RIM STRIPS	<b>462</b>





DOWNFORCE SPOILERS SPORT	<b>40</b>
DOWNFORCE SPOILERS RACE	<b>42</b>
FRONTAL SPOILER GP	<b>44</b>
DOWNFORCE SPOILERS NAKED	<b>46</b>
FRONTAL SPOILER NAKED	<b>48</b>



# WORLD SBK KAWASAKI RACING TEAM



7 WORLD SUPERBIKE CHAMPIONSHIP





REPSOL  
36

# MOTO GP REPSOL HONDA TEAM

**HRC**  
Honda RACING  
OFFICIAL  
SPONSOR

17 MOTOGP WORLD CHAMPIONSHIP





# WORLD SBK YAMAHA RACING TEAM





**KAWASAKI  
CATALA RACING TEAM  
ENDURANCE 24H CATALUNYA**



**KAWASAKI  
SRC TEAM  
EWC**



**BOX 77  
RACING TEAM  
ESBK**



**TECMAS RACING TEAM  
FSBK**



**TEAM #109  
WORLDSSP300**



**TEAM LAGLISSE  
ESBK**



**WESTBY RACING TEAM  
MOTOAMERICA**



# DOWNFORCE SPOILERS SPORT



\* Check availability for motorcycle models at [www.puig.tv](http://www.puig.tv) typing in the searching window:

**SPORT SPOILERS**



**ABE**  
31948

**PMMA**  
ACRYLIC



**NO DRILL**



**AERODYNAMIC**



## BODY

Polyamide 4 mm.

 **N Black**

## DEFLECTOR COLOR

 **A Blue**

 **N Black**

 **R Red**

 **V Green - Polymethyl methacrylate 3 mm.**



**ANTI-WHEELIE**



**ANTI SHIMMIE**

More stability on straights.



**DOWNFORCE**

More composure when braking.



**STABILITY**

More stability when changing direction.



SIDE SPOILERS  
AERODYNAMIC TEST REF. 9766

YAMAHA YZF-R1 / M  
2015

**DOWNFORCE - SPEED GRAPHIC**

Speed (km/h)	Downforce (kg)
80	0.5
100	1.0
120	1.5
140	2.0
160	2.5
180	3.0
200	3.5
220	4.0
240	4.5
260	5.0
280	5.5
300	5.9

The Downforce that the spoilers generates rises potentially as the speed increases. at 300 km/h we get 5.9 Kg/f.

El downforce generado por los Spoilers, se incrementa al aumentar la velocidad, a 300km/h podemos obtener 5.9kg/f.

**5.9Kg/f**

They consist of:

- Set of spoilers made of 4 mm. thick CN High-Impact acrylic. Always in black.
- Set of deflectors available in colors.

Puig's Downforce Sport spoilers have been developed thanks to the experience and tests carried out by the Kawasaki Racing team on the WorldSBK championship circuits. Get the ultimate racing touch and improve the cornering of your motorcycle with these Downforce Sport spoilers.

Aerodynamic test supplied along most of our spoilers.



# DOWNFORCE SPOILERS RACE



\* Check availability for motorcycle models at [www.puig.tv](http://www.puig.tv) typing in the searching window:

**RACE SPOILERS**



NO DRILL

AERODYNAMIC

## BODY

TPU with 3M adhesive.

 N Black

## DEFLECTOR COLOR

 H Smoke

 N Black

 R Red

 V Green - Polymethyl methacrylate 3 mm.



REF. 20543N



**ANTI-WHEELIE**



**ANTI SHIMMIE**

More stability on straights.



**DOWNFORCE**

More composure when braking.



**STABILITY**

More stability when changing direction.

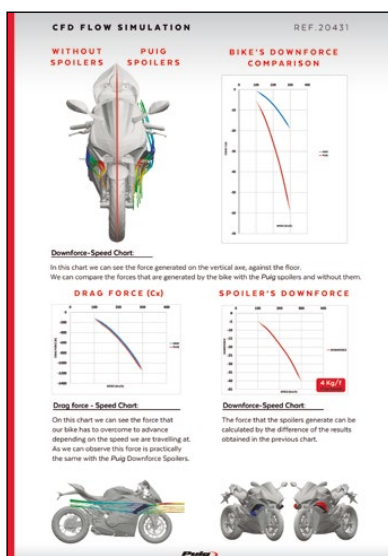

They are made up of two elements:

- Supports injected in flexible black plastic that adapt perfectly to the fairing of your motorcycle by means of a 3M dual lock adhesive, strong, resistant and durable, but that can be removed and does not damage or require holes in your fairing.
- Spoiler in closed form, which is made of 4 mm. acrylic material. To choose a color, following safety regulations, with rounded edges with a radius >2 mm., a highly rigid and light material that is perfect for receiving aerodynamic pressure and directly translating it into downforce.

This product, extracted from the experience of the brand in the Moto GP championship, manages to provide greater air pressure in the front end in high-speed sections and improve cornering.

Aerodynamic test supplied along most of our spoilers.



# FRONTAL SPOILER GP



\* Check availability for motorcycle models at [www.puig.tv](http://www.puig.tv) typing in the searching window.

**GP SPOILERS**



**ABE**  
31948

**PMMA**  
ACRYLIC



NO DRILL

**TPU**



AERODYNAMIC

## BODY

TPU 4 mm.

N Black

## DEFLECTOR COLOR

A Blue

H Smoke

N Black

R Red

W Clear



REF. 20508N



**ANTI-WHEELIE**



**ANTI SHIMMIE**

More stability on straights.



**DOWNFORCE**

More composure when braking.



**STABILITY**

More stability when changing direction.

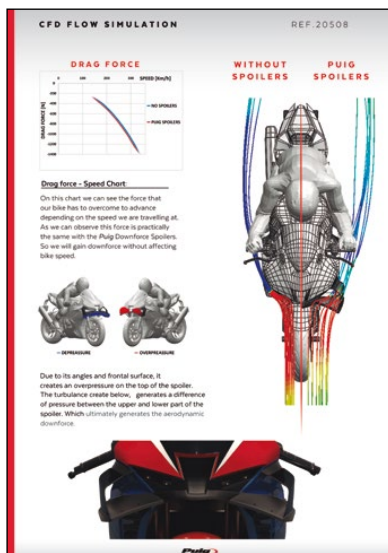

The new Frontal Spoiler GP is the mix of the most advanced knowledge and technologies in the field of competition motorcycling, and has been designed and manufactured entirely in Barcelona.

Made of 4 mm. ABS, a highly resistant material against impacts, with a matt black finish, it will provide your vehicle with a new aerodynamic plus, in addition to giving it a sport and elegant character according to the aesthetics of your motorcycle.

Mounting it to your motorcycle will be a simple and fast task, without the need for specific mechanical knowledge or tools and without requiring holes for mounting.

Aerodynamic test supplied along most of our spoilers.

# DOWNFORCE SPOILERS NAKED



\* Check availability for motorcycle models at [www.puig.tv](http://www.puig.tv) typing in the searching window:

**NAKED SPOILERS**



NO DRILL

AERODYNAMIC

## BODY

TPU 4 mm.

**N** Black

## DEFLECTOR COLOR

**A** Blue

**F** Dark Smoke

**J** Matt black

**N** Black

**R** Red

**T** Orange

**V** Green - ABS 4 mm.





REF. 20380R



**ANTI-WHEELIE**



**ANTI SHIMMIE**

More stability on straights.



**DOWNFORCE**

More composure when braking.



**STABILITY**

More stability when changing direction.



SIDE SPOILERS  
AERODYNAMIC TEST REF. 20327

**KAWASAKI Z900**  
2017-2019

The Downforce that the spoilers generates raises potentially as the speed increases, at top speed we get 3.3 Kg/f

El downforce generado por los Spoilers, se incrementa al aumentar la velocidad, a máxima velocidad conseguimos 3.3 kg/f

**3.3 Kg/f**  
Puig

Naked spoilers are made up of:

- Spoiler-covers in matt black ABS material, which are easily installed on your motorcycle by means of metal supports with an anti-corrosion finish in black, light and resistant.
- Deflectors, which are made of 4 mm. thick CN acrylic material and a color to choose from (colors defined according to models). These deflectors have a rounded  $\varnothing$  4 mm. edge for greater rider safety.

The NAKED spoilers are an adaptation of the most cutting-edge innovations in competition in the field of aerodynamics applied to your motorcycle, providing it with the best performance and an incomparable sport style. Designed and manufactured in Barcelona with the most advanced technologies to achieve a technical product with the best aesthetics and finishes.

Aerodynamic test supplied along most of our spoilers.



# FRONTAL SPOILER NAKED



\* Check availability for motorcycle models at [www.puig.tv](http://www.puig.tv) typing in the searching window.

**NAKED SPOILERS**



NO DRILL

AERODYNAMIC

## DEFLECTOR COLOR



J Matt black - ABS 3 mm.



REF. 3482J



**ANTI-WHEELIE**



**ANTI SHIMMIE**

More stability on straights.



**DOWNFORCE**

More composure when braking.



**STABILITY**

More stability when changing direction.

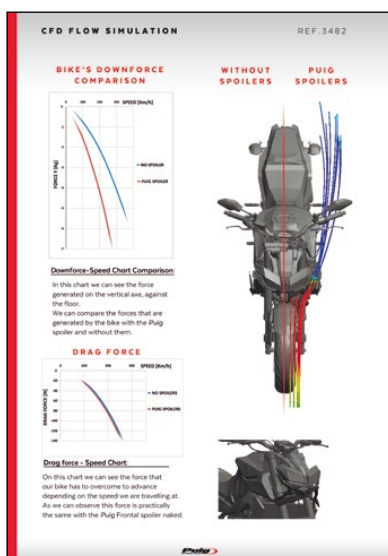

Boost the aesthetics and sport character, as well as improving the aerodynamic aspect, of your motorcycle with the Naked front spoiler from Puig.

Designed in Barcelona with the most innovative technologies, the new Naked front spoiler is made of 3 mm. matt black ABS, highly resistant material to any type of impact, which gives your motorcycle that aggressive look as well as elegance that you are looking for.

The assembly will be a simple and fast task, without the need for specific mechanical knowledge affecting any critical area of the motorcycle, since it is fixed to the vehicle through a 3 mm. metal support.

Aerodynamic test supplied along most of our spoilers.

# 1

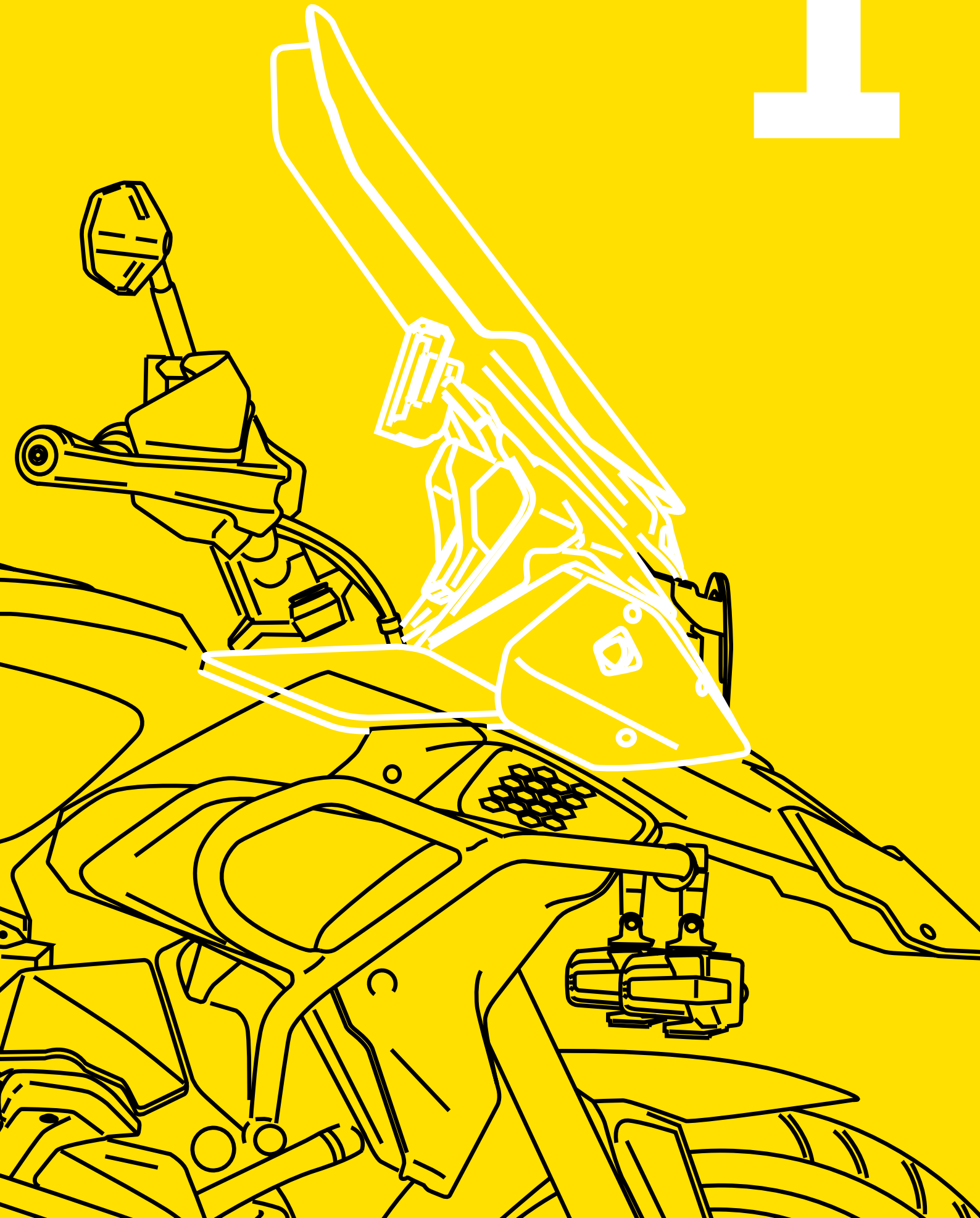

# SUPERIOR FRONT AREA

ADJUSTABLE WINDSCREEN	<b>68</b>	WINDSHIELD CITY TOURING	<b>148</b>
ANARCHY SEMI-FAIRINGS	<b>140</b>	WINDSHIELD COCKPIT	<b>107</b>
BATWING SML	<b>144</b>	WINDSHIELD CUSTOM I	<b>113</b>
CLOCK TOPS	<b>92</b>	WINDSHIELD CUSTOM II	<b>114</b>
DARK NIGHT SEMI-FAIRINGS	<b>142</b>	WINDSHIELD DAYTONA III	<b>121</b>
DASHBOARD PROTECTOR	<b>154</b>	WINDSHIELD DAYTONA IV	<b>120</b>
DEFLECTORS FOR WINDSHIELDS	<b>90</b>	WINDSHIELD FLANKER	<b>98</b>
E.R.S. (ELECTRONIC REGULATION SYSTEM)	<b>78</b>	WINDSHIELD GTS SPORT	<b>146</b>
EXTENDED FRONT DEFLECTORS	<b>93</b>	WINDSHIELD GTS TOURING	<b>147</b>
FRONTAL PLATE (IN ABS)	<b>132</b>	WINDSHIELD HIGHWAY	<b>119</b>
FRONTAL PLATE (IN ALUMINIUM)	<b>130</b>	WINDSHIELD MITO	<b>101</b>
FURY SEMIFARING	<b>136</b>	WINDSHIELD NAKED	<b>105</b>
HANDGUARDS	<b>153</b>	WINDSHIELD NEW GENERATION	<b>96</b>
HIGH-ROAD SCREEN	<b>134</b>	WINDSHIELD PLUS	<b>112</b>
M.E.M. (MANUAL ELEVATION MECHANISM)	<b>76</b>	WINDSHIELD RAFALE	<b>99</b>
MIRAGE SEMI-FAIRINGS	<b>138</b>	WINDSHIELD RANGER	<b>115</b>
MULTI-ADJUSTABLE VISORS 2.0 CLIP-ON	<b>84</b>	WINDSHIELD RAPTOR	<b>106</b>
MULTI-ADJUSTABLE VISORS 2.0 FIXED BY SCREWS	<b>82</b>	WINDSHIELD ROADSTER	<b>117</b>
MULTI-ADJUSTABLE VISORS CLIP-ON	<b>88</b>	WINDSHIELD T.S.	<b>151</b>
MULTI-ADJUSTABLE VISORS FIXED BY SCREWS	<b>86</b>	WINDSHIELD T.X.	<b>152</b>
R-RACER WINDSCREEN	<b>54</b>	WINDSHIELD TOP	<b>111</b>
RACING WINDSCREEN	<b>56</b>	WINDSHIELD TOURING I	<b>116</b>
REINFORCEMENT SUPPORT	<b>70</b>	WINDSHIELD TOURING II	<b>104</b>
RETROVISIONS	<b>128</b>	WINDSHIELD TRAFIC	<b>149</b>
SCREWS	<b>72</b>	WINDSHIELD TREND	<b>103</b>
SEMI-FAIRINGS	<b>126</b>	WINDSHIELD UP&DOWN	<b>102</b>
SEMIFAIRING RALLY	<b>74</b>	WINDSHIELD URBAN	<b>150</b>
SPORT WINDSCREEN	<b>58</b>	WINDSHIELD VISION	<b>110</b>
TOURING PLUS SCREEN WITH VISOR	<b>66</b>	WINDSHIELD WAVE	<b>108</b>
TOURING PLUS WINDSHIELD	<b>62</b>	WINDSHIELD WINDY	<b>109</b>
TOURING SCREEN WITH VISOR	<b>64</b>	WINDSHIELDS FOR MAXISCOOTERS	<b>80</b>
TOURING WINDSHIELD	<b>60</b>	Z-RACING WINDSCREEN	<b>52</b>
UPPER DEFLECTORS	<b>94</b>		
WINDSHIELD AMERICA I	<b>122</b>		
WINDSHIELD AMERICA II	<b>123</b>		
WINDSHIELD AMERICA III	<b>124</b>		
WINDSHIELD BAT	<b>100</b>		
WINDSHIELD CHOPPER	<b>118</b>		



# Z-RACING WINDSCREEN



\* Check availability for motorcycle models at [www.puig.tv](http://www.puig.tv) typing in the searching window:

**ZRACING**



 **A Blue**

 **F Dark Smoke**

 **H Smoke**

 **R Red**

 **V Green**

 **C Carbon look**

 **G Yellow**

 **N Black**

 **T Orange**

 **W Clear**



AERODYNAMIC



REF. 20541H



The Z-Racing windscreen reaches the perfect equilibrium between an sportive design and an increase on aerodynamic protection for the rider.

Higher than the oem, its studied shapes include edges to divert the airflow to the sides, avoiding the impact on the helmet and superior part of the riders torso.

Manufactured in 3 mm. high-impact acrylic assuring excellent durability and a perfect optical vision. The edges are 2 mm. rounded to comply with the german TÜV regulation.

Available in a wide color selection.

Aerodynamic test delivered with almost all our screens.

**NOTE:** To replace or change the screws of the windscreen, please check page 72.

# R-RACER WINDSCREEN



\* Check availability for motorcycle models at [www.puig.tv](http://www.puig.tv) typing in the searching window:

**RACER**



F Dark Smoke

N Black

H Smoke

W Clear



REF. 20540H



Developed through tests on MotoGP and WSBK, the R-Racer windscreen is higher than the oem and Puig Z-Racing, offering a more aerodynamic protection and a broad visual field with its design without edges keeping the attractive racing look.

Manufactured in 3 mm. high-impact acrylic assuring excellent durability and a perfect optical vision. The edges are 2 mm. rounded to comply with the german TÜV regulation.

Available in clear, light smoke, dark smoke and black.

Aerodynamic test delivered with almost all our screens.

**NOTE:** To replace or change the screws of the windscreen, please check page 72.



# RACING WINDSCREEN



\* Check availability for motorcycle models at [www.puig.tv](http://www.puig.tv) typing in the searching window:

**RACING**



 **A** Blue

 **C** Carbon look

 **F** Dark Smoke

 **G** Yellow

 **H** Smoke

 **N** Black

 **R** Red

 **T** Orange

 **V** Green

 **W** Clear



AERODYNAMIC



REF. 20471N



Derived from competition and higher than oem, the double height offers more aerodynamic protection ideal for a urban rides as well a track and highway. Moreover, it provides a personalized racing look maintaining the rider wind protection.

Manufactured in 3 mm. high-impact acrylic assuring excellent durability and a perfect optical vision. The edges are 2 mm. rounded to comply with the german TÜV regulation.

Available in several colors.

Aerodynamic test delivered with almost all our screens.

**NOTE:** To replace or change the screws of the windscreen, **please check page 72.**

# SPORT WINDSCREEN



\* Check availability for motorcycle models at [www.puig.tv](http://www.puig.tv) typing in the searching window.

**SPORT**



**A** Blue  
**C** Carbon look

**F** Dark Smoke  
**G** Yellow

**H** Smoke  
**N** Black

**R** Red  
**T** Orange

**V** Green  
**W** Clear



REF. 20460F

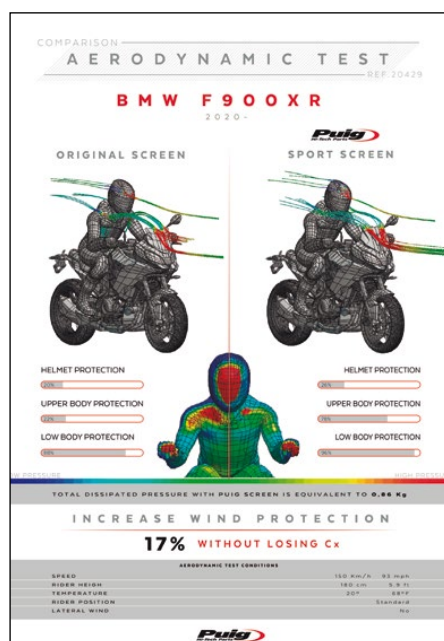

With an attractive sportive design and a more compact dimensions that oem, the Sport windscreen offers great polyvalence as it is ideal for urban and offroad riding thanks for a broad field of vision. More, it is compatible with the motorcycles that have a windscreen lift-up support.

Manufactured in 3 or 4 mm. high-impact acrylic assuring excellent durability and a perfect optical vision. The edges are 2 mm. rounded to comply with the german TÜV regulation.

Available in different colors to choose the one that fits best your bike.

Aerodynamic test delivered with almost all our screens.

**NOTE:** To replace or change the screws of the windscreen, **please check page 72.**



# TOURING WINDSHIELD



\* Check availability for motorcycle models at [www.puig.tv](http://www.puig.tv) typing in the searching window:

**TOURING**



A Blue

H Smoke

F Dark Smoke

N Black

W Clear



REF. 21393H

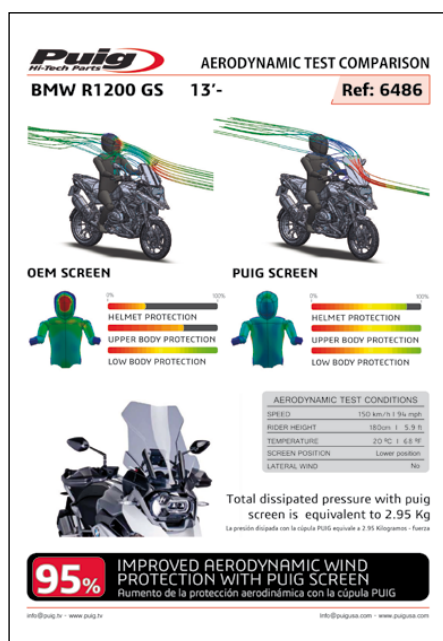

The Touring windshield is the ideal accessory for riders searching to increase the aerodynamic protection without compromising the field of vision.

Its modern style perfectly adapts to the design of the Adventure bikes. Moreover, it is available in clear, light smoke, dark smoke and black for a better personalization.

Developed through our virtual wind tunnel, it is designed with a V shape to divert the airflow through the sides in a clean way, without turbulences and annoying noises, avoiding the impact to the helmet and superior part of the torso.

Manufactured in 4 mm. high-impact acrylic assuring excellent durability and a perfect optical vision. The edges are 2 mm. rounded to comply with the german TÜV regulation.

If you are searching for more protection, Puig offers multi-adjustable visors which can be mounted on oem or our windshields. Please check our catalog on **page 82-89** or our site **www.puig.tv** to see the recommended visor for your motorcycle.

Aerodynamic test delivered with almost all our screens.

**NOTE:** To replace or change the screws of the windscreen, **please check page 72.**

# TOURING PLUS WINDSHIELD



\* Check availability for motorcycle models at [www.puig.tv](http://www.puig.tv) typing in the searching window:

**TOURING PLUS**



A Blue

H Smoke

F Dark Smoke

N Black

W Clear



AERODYNAMIC



REF. 20816F

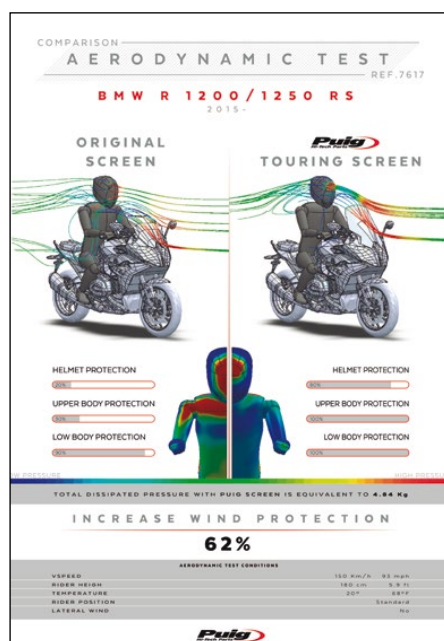

Intended for hard riding routes searching for maximum aerodynamic protection, the Touring Plus windshields are higher than oem and Puig Touring windshields.

Maintains the modern design which perfectly adapts to the Adventures bikes, and they are available in clear, light smoke and dark smoke.

Developed through our virtual wind tunnel, it is designed with a V shape to divert the airflow through the sides in a clean way, without turbulences and annoying noises, avoiding the impact to the helmet and superior part of the torso

Manufactured in 4 mm. high-impact acrylic assuring excellent durability and a perfect optical vision. The edges are 2 mm. rounded to comply with the german TÜV regulation.

If you are searching for more protection, Puig offers multi-adjustable visors which can be mounted on oem or our windshields. Please check our catalog on [page 82-89](#) or our site [www.puig.tv](http://www.puig.tv) to see the recommended visor for your motorcycle.

Aerodynamic test delivered with almost all our screens.

**NOTE:** To replace or change the screws of the windscreen, **please check page 72.**



# TOURING SCREEN WITH VISOR



\* Check availability for motorcycle models at [www.puig.tv](http://www.puig.tv) typing in the searching window:

**VISOR TOURING**



- H Smoke
- W Clear



AERODYNAMIC



REF. 3818H

### THERE ARE FOUR MODELS OF VISORS AVAILABLE DEPENDING ON THE SCREEN:

VS1

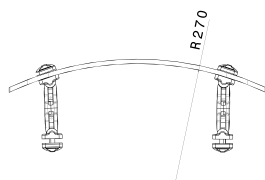
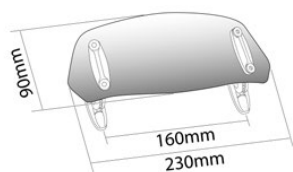

VS2

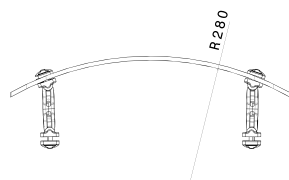
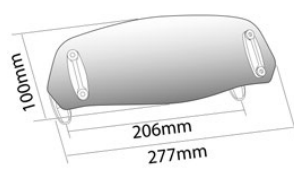

VS3

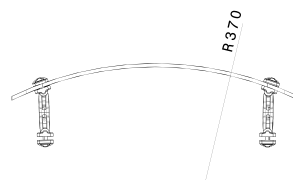
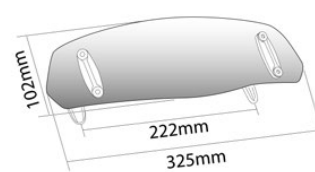

VS4

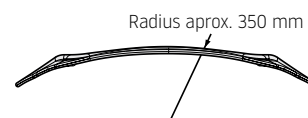
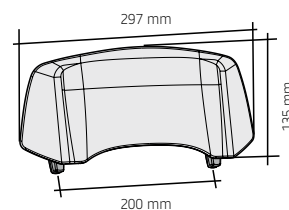

Touring screen with multi-adjustable visor fixed by screws incorporated as standard. This way the rider can choose at any time, quickly and easily if he needs extra aerodynamic protection.

Larger than the original screen, it is developed with wind tunnel technology. It includes a V-shaped design to divert the air to the sides cleanly without turbulence and annoying noise, preventing it from impacting the head and rider's torso, therefore improving riding comfort and reducing fatigue.

Made of 4 mm. thick acrylic material, offers excellent strength and transparency. It has 2 mm. rounded edges, for greater safety, complying with the German TÜV regulations. Available in smoke to match the visor.

**NOTE:** To replace or change the screws of the windscreen, **please check page 72.**

# TOURING PLUS SCREEN WITH VISOR



\* Check availability for motorcycle models at [www.puig.tv](http://www.puig.tv) typing in the searching window:

**VISOR PLUS**







AERODYNAMIC

REF. 20816H



### THERE ARE FOUR MODELS OF VISORS AVAILABLE DEPENDING ON THE SCREEN:

VS1

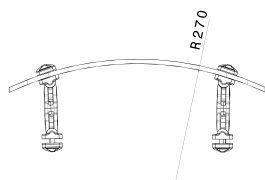
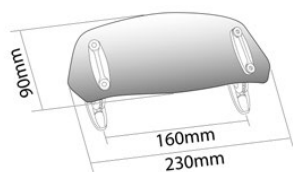

VS2

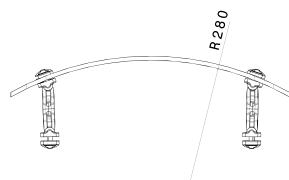
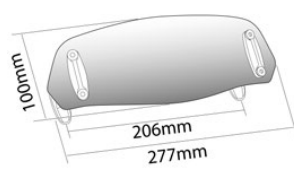

VS3

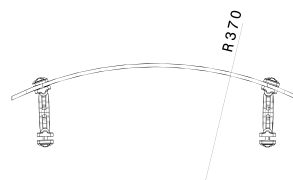
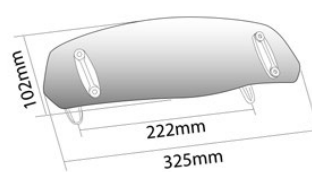

VS4

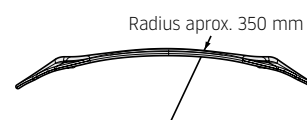
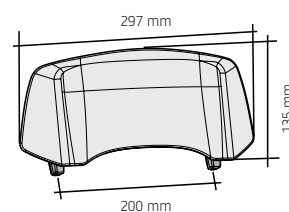

It further increases the aerodynamic protection of the Touring Plus screen by incorporating a multi-adjustable visor fixed by screws. Ideal for taller riders looking for better protection in the helmet area.

Larger than the original screen and the Puig Touring model, it is developed with wind tunnel technology with a V-shaped design to divert the air to the sides cleanly without turbulence and annoying noise, preventing impacts to the rider's head and upper torso. It improves riding comfort and reduces fatigue.

Made of 4 mm. thick acrylic material, offers excellent strength and transparency. It has 2 mm. rounded edges, for greater safety, complying with the German TÜV regulations. Available in smoke to match the visor.

**NOTE:** To replace or change the screws of the windscreen, **please check page 72.**

# ADJUSTABLE WINDSCREEN



\* Check availability for motorcycle models at [www.puig.tv](http://www.puig.tv) typing in the searching window:

**ADJUSTABLE SCREEN**



A Blue

H Smoke

F Dark Smoke

N Black

W Clear

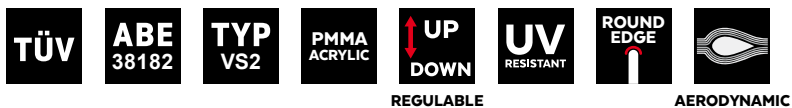

REGULABLE

AERODYNAMIC

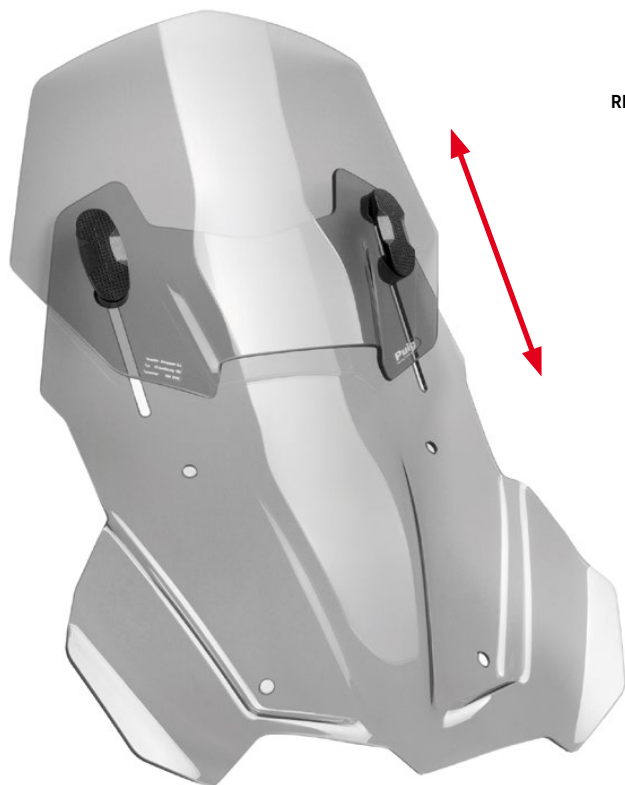

REF. 3179H



Thanks to the incorporation of an adjustable mechanism, the height of the screen can be raised quickly and easily, immediately adapting to the needs of each situation and type of ride like off road, city, highway...

Larger than the original screen, this versatile screen has been designed and developed with wind tunnel technology, which diverts the air to the sides cleanly without turbulence and annoying noise, preventing it from impacting the head and the rider's upper torso. This will improve the rider's riding comfort and reduce fatigue.

Made of high impact methacrylate, it offers excellent strength and transparency. It has rounded edges for greater rider safety. Available in several shades to better match your motorcycle.

Aerodynamic test delivered with almost all our screens.

**NOTE:** To replace or change the screws of the windscreen, **please check page 72.**



# REINFORCEMENT SUPPORT



\* Check availability for motorcycle models at [www.pug.tv](http://www.pug.tv) typing in the searching window.

**REINFORCEMENT SUPPORT**





REF. 7566N



The reinforcement support designed by Puig provides extraordinary rigidity to the windshield assembly. Once assembled and unlike other systems, it is not necessary to loosen the nut to move the screen.

This mechanism is designed so that it works in any position of the screen and without any adjustment.

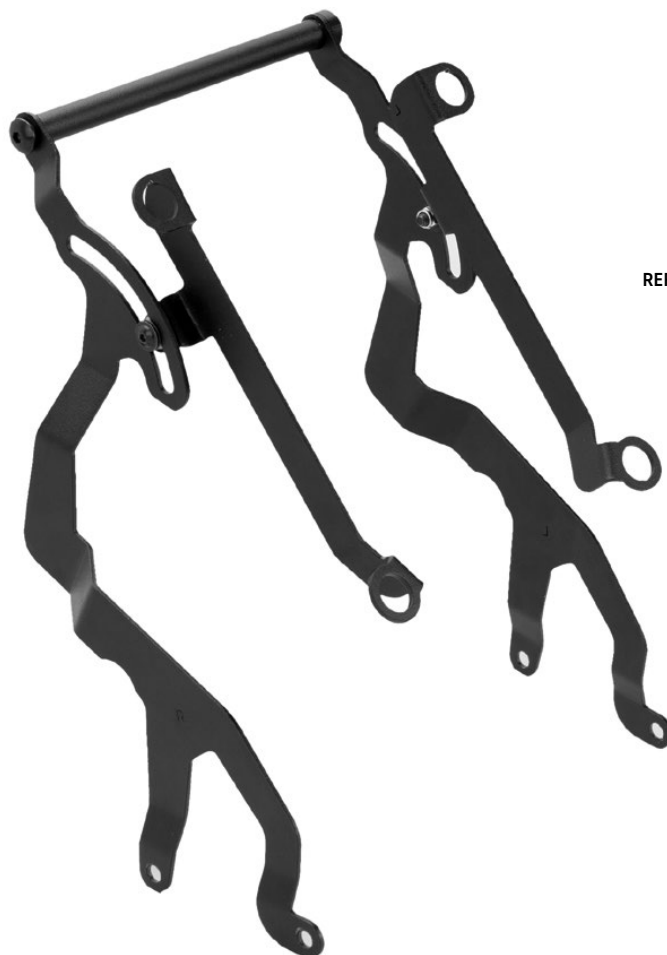

REF. 21334N

# SCREWS



\* Check availability for motorcycle models at [www.puig.tv](http://www.puig.tv) typing in the searching window:

**SCREWS**



## SCREEN SCREWS

MODEL	REF.	AGLNPRV
BLISTER 8 SCREWS M5 WITH NUTS	0956	(*)
BLISTER 8 SCREWS M5 WITH WELLNUTS	0957	(*)

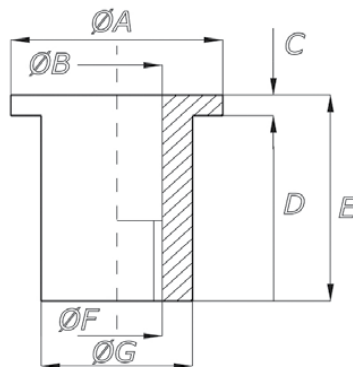

## WELLNUTS

A x B x C x D x E x G	REF.	N
14 x 6 x 1,5 x 13,5 x 15 x 10 M5	0714N	(*)
15 x 7 x 1,5 x 13,5 x 15 x 12,5 M6	0715N	(*)
14 x 5 x 1,5 x 11,5 x 13 x 10 M4	1887N	(*)

With nut incorporated (25 units in sac).

**A** Blue  
**G** Yellow

**L** Violet  
**N** Black

**P** Silver  
**R** Red

**V** Green

(\*) Check price with your distributor.



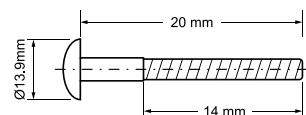
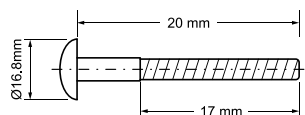
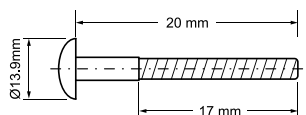
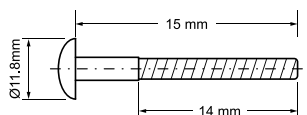

# NEW!

## ALUMINIUM HARDWARE FOR SCREENS, FAIRINGS AND COVERS

MODEL	REF.	AGLNPRV
BLISTER 6 SCREWS M5X15 Ø 11,8 mm.	21763	(*)
BLISTER 6 SCREWS M6X20 Ø 13,9 mm.	21764	(*)
BLISTER 6 SCREWS M6X20 Ø 16,8 mm.	21765	(*)
BLISTER 6 SCREWS M5X20 Ø 13,9 mm.	21766	(*)

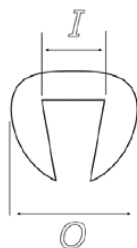

## TRIM - EDGING

O x I	COLOR	REF.	ROLL	HW
6,2 x 2,6	CLEAR	5843W	2 mts.	(*)
6,2 x 2,6	SMOKE	5843H	2 mts.	(*)

H Smoke

N Black

W Clear

(\*) Check price with your distributor.

# SEMIFAIRING RALLY



\* Check availability for motorcycle models at [www.puig.tv](http://www.puig.tv) typing in the searching window:

**RALLY**



**IMPACT  
RESISTANT**



**UV  
RESISTANT**



**NO DRILL**



**ROUND  
EDGE**



**AERODYNAMIC**



**CE  
HOMOLOGATED**

Led  
Optics  
10W

W Clear



REF. 20548W



REF. 20507W

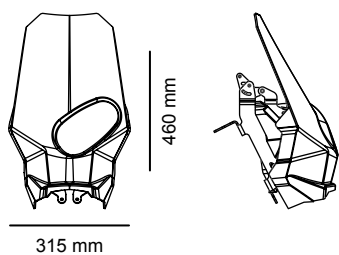

315 mm

460 mm



The semifairings are served with an adhesive kit that uses the same aesthetic and colors as the motorcycle.



The Rally semifairing is a complement for your off-road motorcycle that will allow you to:

- Improve aerodynamics thanks to the polycarbonate screen that redirects the air, improving the rider's protection.
- Improve lighting thanks to two LED headlights if we compare them to the originals of the motorcycle.
- Install the navigation system that best suits your needs, such as a Roadbook, Mobile Phone or a GPS and adjust it to the position you want, resisting the bumps and jumps that may occur when on the road. It should also be noted that your navigation system will be 100% protected by the screen from possible impacts, stones, dust...





# M.E.M. (MANUAL ELEVATION MECHANISM)



\* Check availability for motorcycle models at [www.puig.tv](http://www.puig.tv) typing in the searching window:

**MEM**



**METALIC  
MADE**

**UP  
DOWN**

REGULABLE

**OEM  
COMPATIBLE**



NO DRILL

**N** Black



**MECHANISM**  
REF. 9955N



**MECHANISM**  
REF. 9955N



**MECHANISM**  
REF. 20504N



**HIGHEST POSITION**



**LOWEST POSITION**



Compact mechanism that allows you to modify the position of the screen of your motorcycle without tools so you can adapt to the different situations that the route demands, raising it and increasing the aerodynamic protection on fast roads or adverse weather conditions, or reducing it in city or offroad driving for a wide field of view without interference, or for a more sport look.

You will be able to activate the mechanism and place the screen in the position you want with a quick and easy twist on the fixings, and fix it again with just your hands, without the need for tools. The mechanism is used for your OEM screen or for Puig screens for your motorcycle.

Aerodynamic test delivered with almost all our screens.

# E.R.S. (ELECTRONIC REGULATION SYSTEM)



\* Check availability for motorcycle models at [www.puig.tv](http://www.puig.tv) typing in the searching window:

ERS

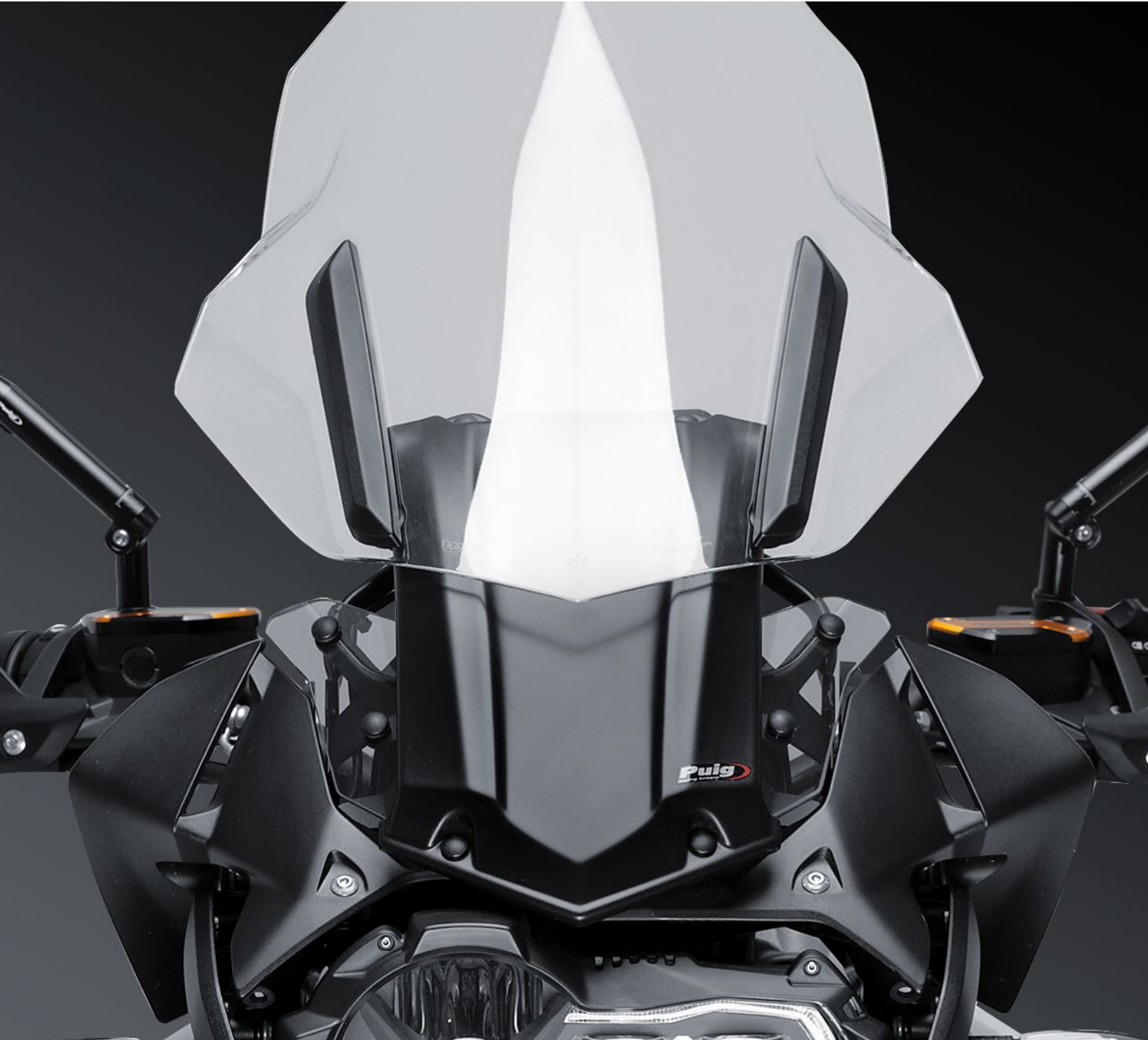

METALIC  
MADE

UP  
DOWN

REGULABLE

OEM  
COMPATIBLE



NO DRILL

■ N Black





AUTOMATIC



PLUG & PLAY



MECHANISM



HIGHEST POSITION

E.R.S. + OEM SCREEN  
UPPER POSITION ↑



LOWEST POSITION

E.R.S. + OEM SCREEN  
LOWER POSITION ↓



Electronic mechanism, easy assembly, which allows the movement of the screen easily by operating a commutator even piloting the motorcycle.

It has a height of 150 mm. To regulate at will of rider, according to his height and the meteorological conditions.

Improves pilot comfort.

It can be mounted with both the Puig screen and the original one.

Aerodynamic test delivered with almost all our screens.

# WINDSHIELDS FOR MAXISCOOTERS



\* Check availability for motorcycle models at [www.puig.tv](http://www.puig.tv) typing in the searching window:

**V-TECH LINE**



AERODYNAMIC

## SPORT / SUPERSPORT

- F Dark Smoke
- H Smoke

- N Black
- W Clear

## TOURING

- F Dark Smoke
- H Smoke

- J Matt black
- W Clear

### SCREEN TESTED IN THE VIRTUAL WIND TUNNE

The V-Tech design has been developed through our Virtual Wind Tunnel to improve OEM aerodynamic penetration.

Its angled shapes on its central and side sections eases the wind canalization redirecting it to both sides of the rider, minimizing turbulences and keeping the radical look of the pieces.

#### PUIG



#### OEM



Improved aerodynamics and wind protection on average +24%.

#### PUIG

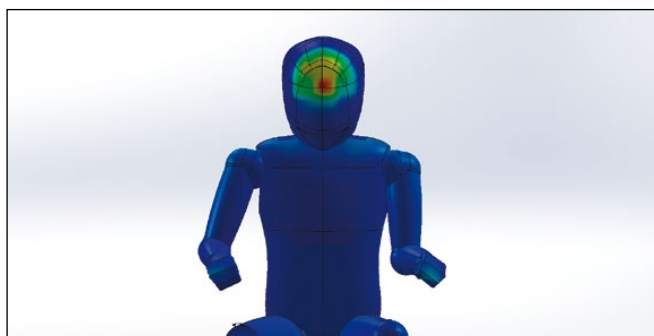

#### OEM

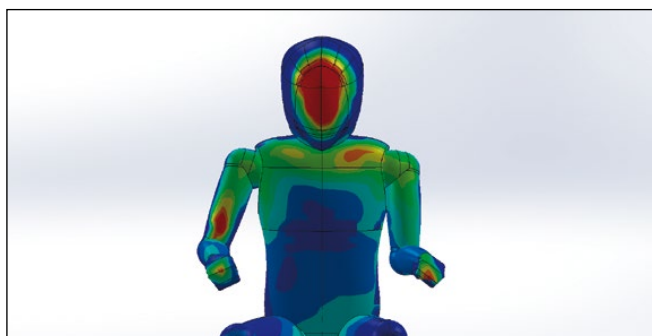

Wind pressure comparison between V-Tech Line Puig and OEM.

### V-TECH LINE MODELS:

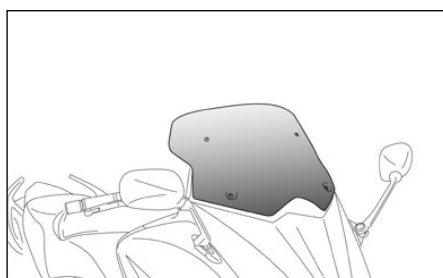

V-TECH LINE SUPERSPORT

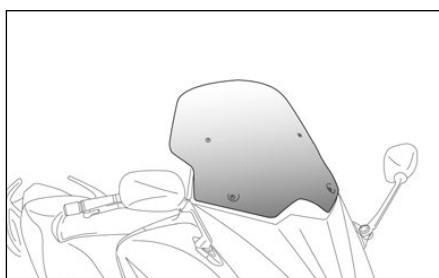

V-TECH LINE SPORT

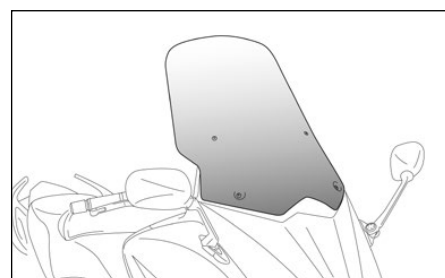

V-TECH LINE TOURING



Check comparative studies for all our V-TECH LINE screens in [our website](#).



# MULTI-ADJUSTABLE VISORS 2.0 FIXED BY SCREWS



\* Check availability for motorcycle models at [www.puig.tv](http://www.puig.tv) typing in the searching window:

**VISOR**



IMPACT  
RESISTANT

AERODYNAMIC

REGULABLE

VISOR

- H Smoke
- W Clear

MECHANISM

- N Black

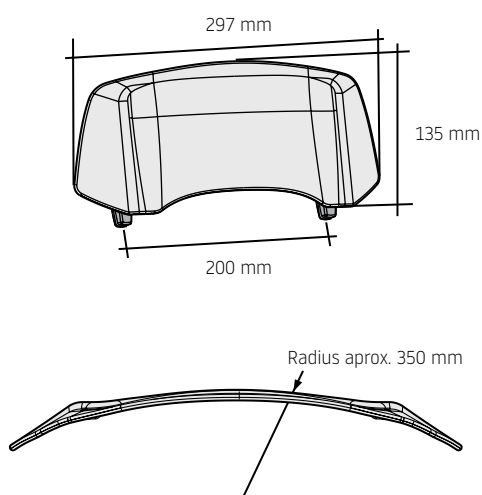

REF.	H W
20763	(*)

#### SPARES

	REF.	H W	N
MULTI-ADJUSTABLE MECHANISM BY PAIR	20766N		(*)
VISOR SPARE (325 x 140 mm.)	20765	(*)	

(\*) Check price with your distributor.

The multi-adjustable bolt-on visors can be mounted on the Puig windscreen as well as on the stock one. The multi-adjustable visors are adjustable on inclination and height.

Check compatibility and references in **our website**.

If you are searching for more protection, Puig offers multi-adjustable visors which can be mounted on oem or our windshields. Please check our catalog on **page 82-89** or our site **www.puig.tv** to see the recommended visor for your motorcycle.

#### ASSEMBLY PROCEDURE

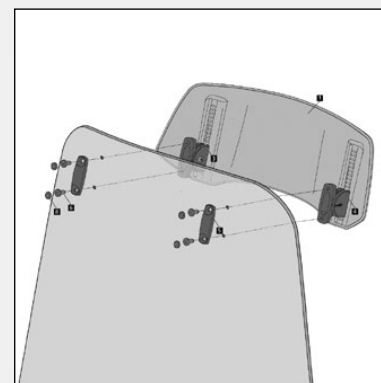
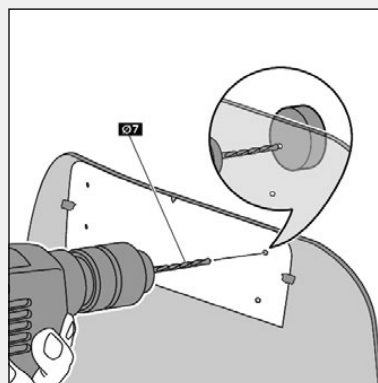
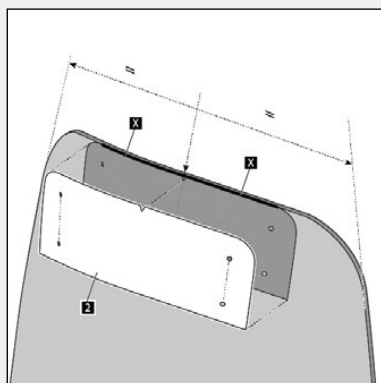

\* Template supplied.

**NOTE:** If order "touring with visor" kit, the windscreen will come factory-drilled so no drilling is necessary.

# MULTI-ADJUSTABLE VISORS 2.0 CLIP-ON



\* Check availability for motorcycle models at [www.puig.tv](http://www.puig.tv) typing in the searching window:

**VISOR**



IMPACT  
RESISTANT

AERODYNAMIC

REGULABLE

NO DRILL

VISOR

- H Smoke
- W Clear

MECHANISM

- N Black



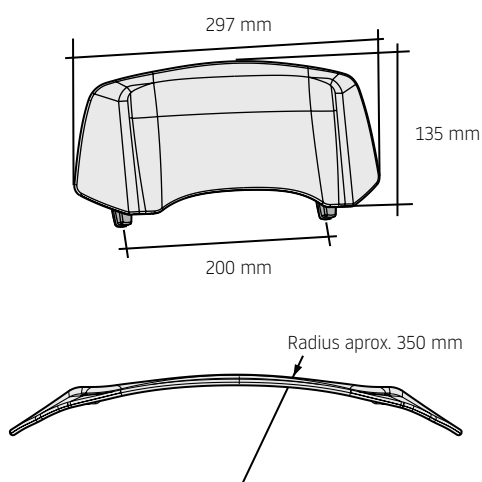

REF.	H W
20764	(*)

**SPARES**

	REF.	H W	N
MULTI-ADJUSTABLE MECHANISM BY PAIR	20767N		(*)
VISOR SPARE (325 x 140 mm.)	20765	(*)	

(\*) Check price with your distributor.

The multi-adjustable clip-on visors can be mounted on the Puig windshield as well as the stock one. The multi-adjustable visors are adjustable on inclination and height.

Check compatibility and references in **our website**.

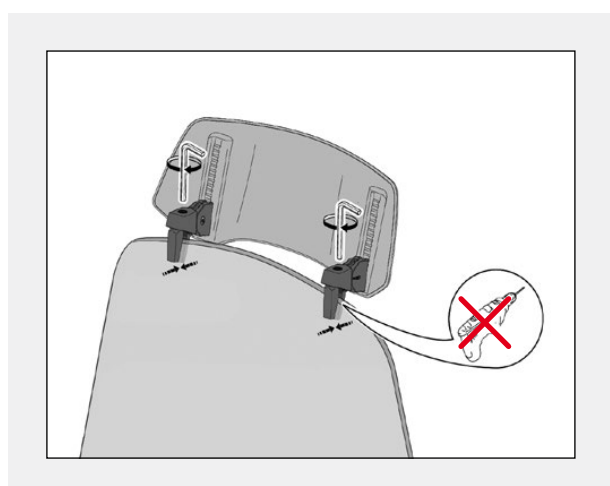
**ASSEMBLY PROCEDURE**

Suitable screen thicknesses between 3 and 5 mm.  
It's not necessary to drill the screen to hold the visor.

**RECOMMENDATIONS**

**REF.** 20764 for OEM windshields of 220 mm. minimum width.

# MULTI-ADJUSTABLE VISORS FIXED BY SCREWS



\* Check availability for motorcycle models at [www.puig.tv](http://www.puig.tv) typing in the searching window:

**VISOR**

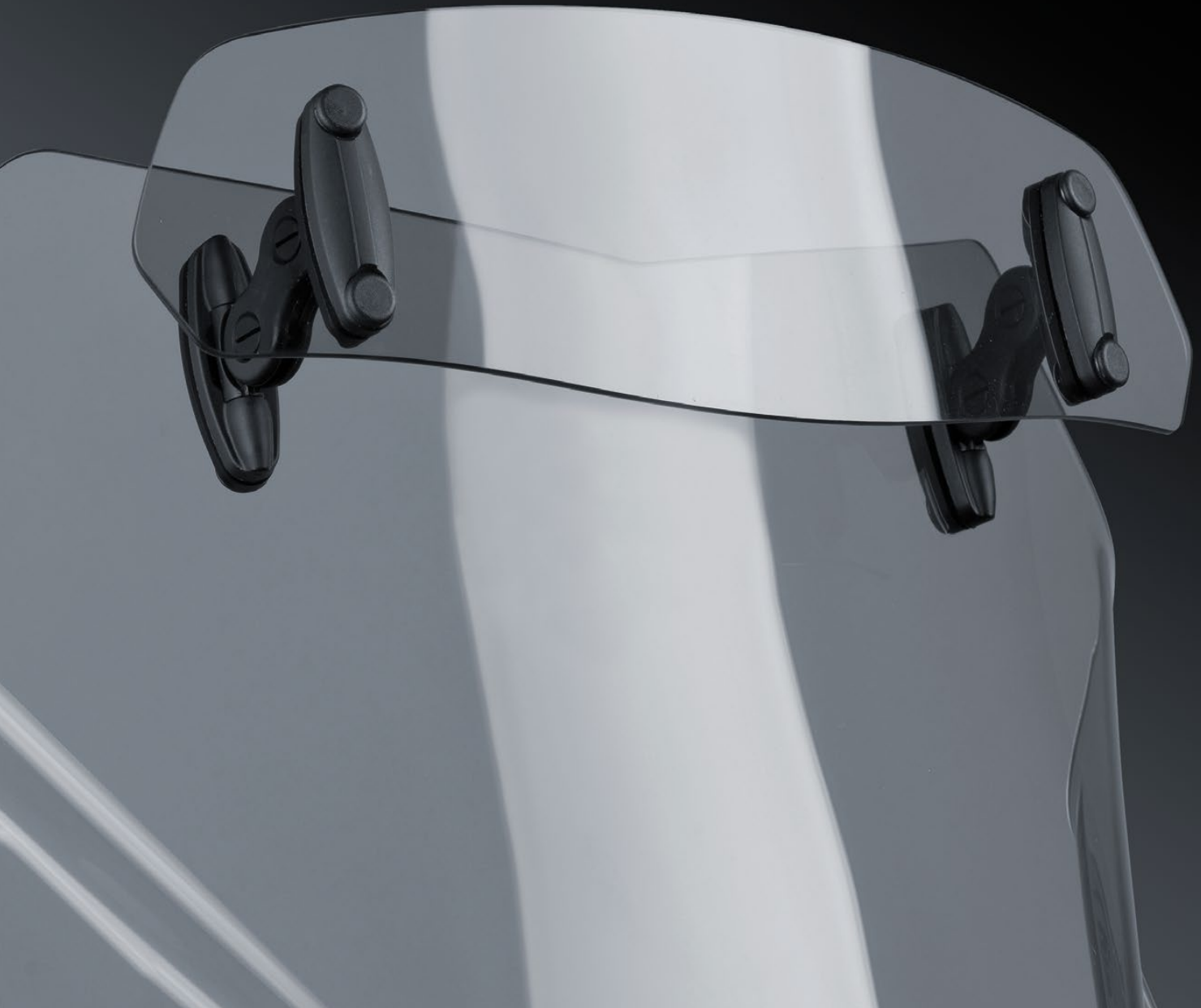

AERODYNAMIC

REGULABLE

VISOR

- H Smoke
- W Clear

MECHANISM

- N Black

1.

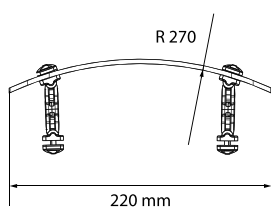
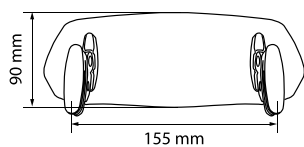

REF.	H W
6007	(*)

2.

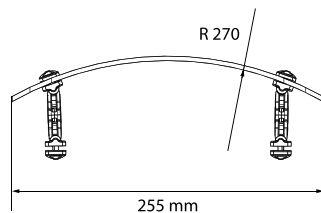
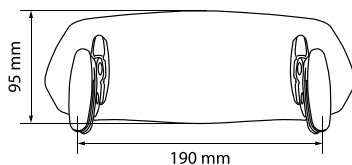

REF.	H W
5852	(*)

3.

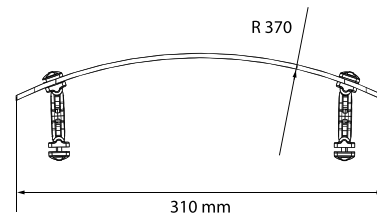
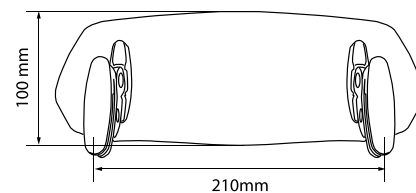

REF.	H W
5853	(*)

## SPARES

	REF.	H W	N
MULTI-ADJUSTABLE MECHANISM BY PAIR	6271		(*)
VISOR SPARE N.1 (220 x 90 mm.)	6268	(*)	
VISOR SPARE N.2 (255 x 95 mm.)	6269	(*)	
VISOR SPARE N.3 (310 x 100 mm.)	6270	(*)	

(\*) Check price with your distributor.

The multi-adjustable bolt-on visors can be mounted on the Puig windscreen as well as on the stock one.

Check compatibility and references in **our website**.

## ASSEMBLY PROCEDURE

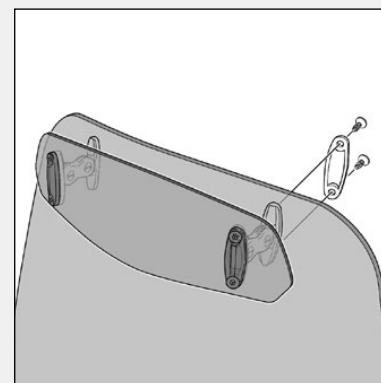
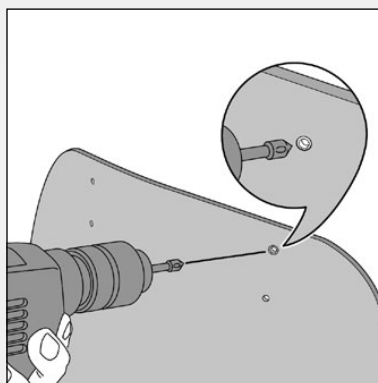
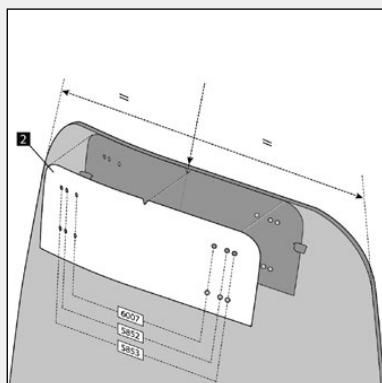

\* Template supplied.

**NOTE:** If order "touring with visor" kit, the windscreen will come factory-drilled so no drilling is necessary.



# MULTI-ADJUSTABLE VISORS CLIP-ON



\* Check availability for motorcycle models at [www.puig.tv](http://www.puig.tv) typing in the searching window:

**VISOR**



IMPACT RESISTANT

AERODYNAMIC

REGULABLE

NO DRILL

**VISOR**

- F Dark Smoke
- H Smoke

- W Clear

**MECHANISM**

- N Black

1.

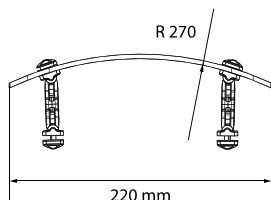
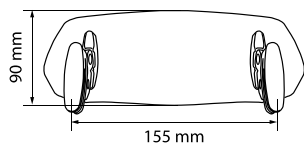

2.

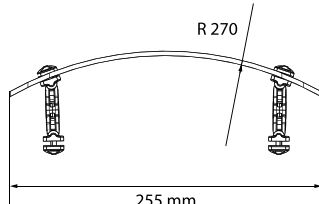
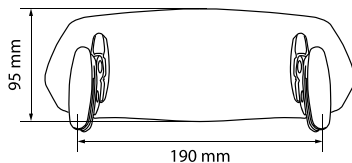

3.

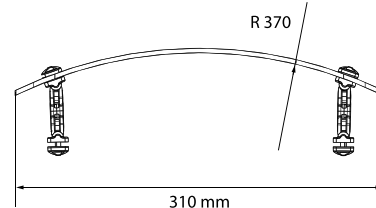
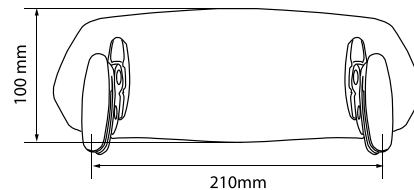

REF.	F H W
6319	(*)

REF.	F H W
6320	(*)

REF.	F H W
6375	(*)

**SPARES**

	REF.	F H W	N
MULTI-ADJUSTABLE MECHANISM BY PAIR	6799		(*)
VISOR SPARE N.1 (220 x 90 mm.)	6871	(*)	
VISOR SPARE N.2 (255 x 95 mm.)	6872	(*)	
VISOR SPARE N.3 (310 x 100 mm.)	6873	(*)	

(\*) Check price with your distributor.

The multi-adjustable clip-on visors can be mounted on the Puig windshield as well as the stock one. Check compatibility and references in **our website**.

**ASSEMBLY PROCEDURE**

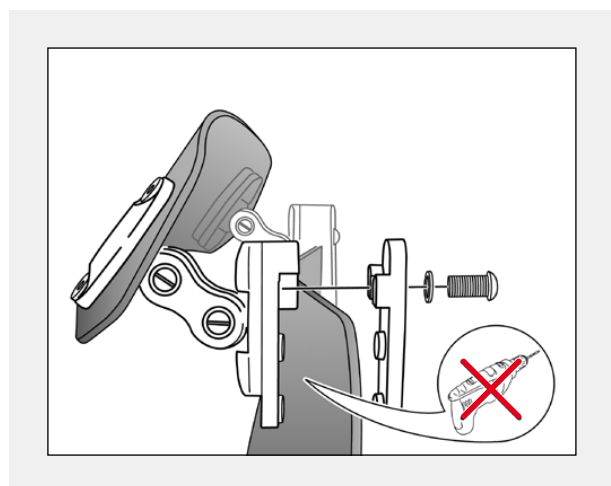

Suitable screen thicknesses between 3 and 5mm. It's not necessary to drill the screen to hold the visor.

**RECOMMENDATIONS**

- REF. 6319 for OEM windshields of 180 mm. minimum width
- REF. 6320 for OEM windshields of 226 mm. minimum width.
- REF. 6375 for OEM windshields of 242 mm. minimum width.

# DEFLECTORS FOR WINDSHIELDS



\* Check availability for motorcycle models at [www.puig.tv](http://www.puig.tv) typing in the searching window:

**VISOR**

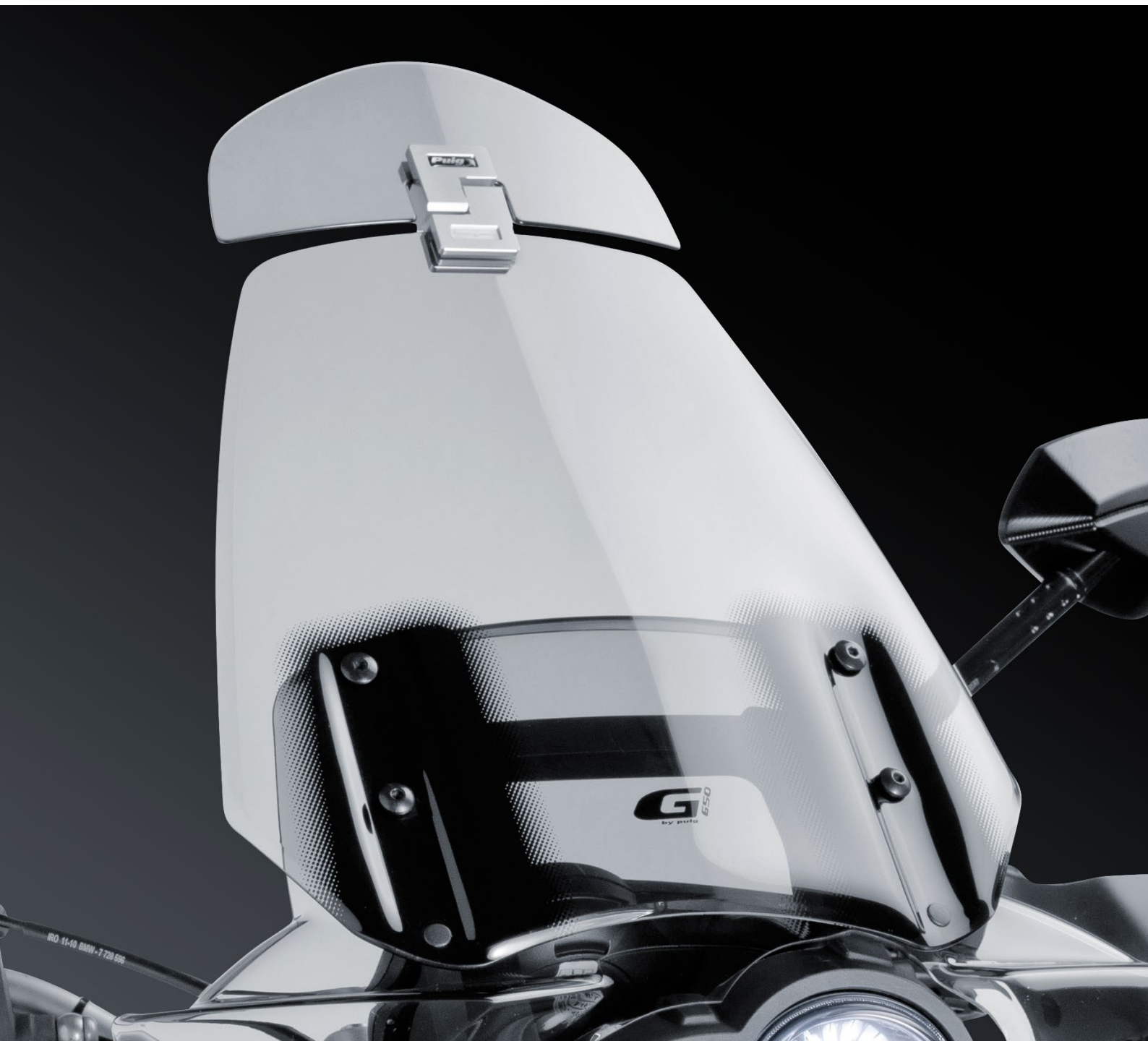

**ABE**  
30774

**PMMA**  
ACRYLIC

**D** Aluminium Anodized

**H** Smoke

**W** Clear





# CLOCK TONS



\* Check availability for motorcycle models at [www.puig.tv](http://www.puig.tv) typing in the searching window:

**CLOCK TONS**

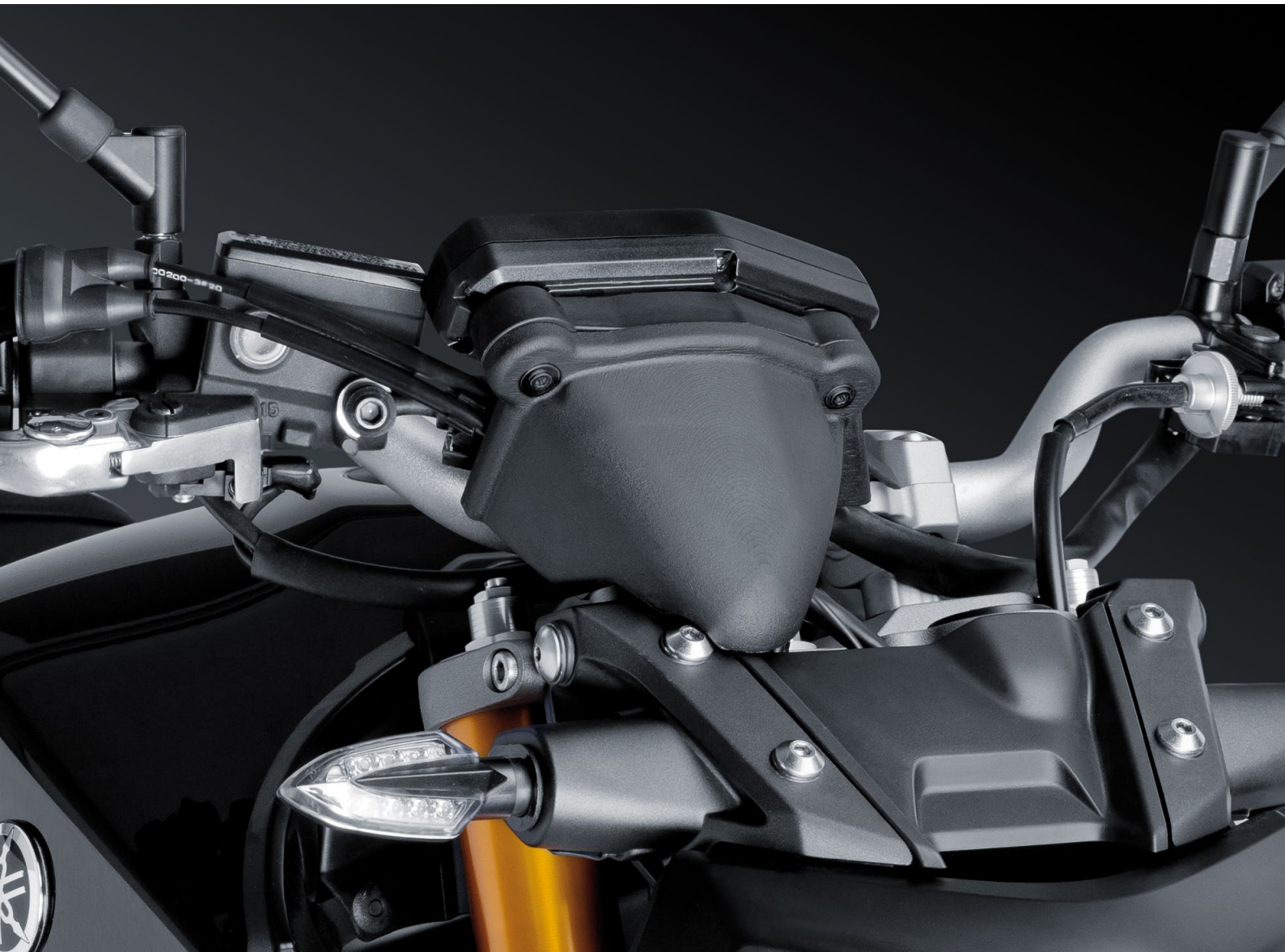

**ABS**



**AERODYNAMIC**

Part made of ABS (matt black) plastic that will protect you from any impacts that the motorcycle's control panel may suffer. In addition, it will allow us to hide and protect the wiring, giving our frame a cleaner look. The installation of the casing is very simple and comes with precise instructions for correct mounting.



**REF. 7515**

**J** Matt black

# EXTENDED FRONT DEFLECTORS



\* Check availability for motorcycle models at [www.puig.tv](http://www.puig.tv) typing in the searching window:

**FRONT DEFLECTOR**



**IMPACT RESISTANT**



**PMMA  
ACRYLIC**



**AERODYNAMIC**

REF. 9225

The protection against the wind is a fundamental part of your bike and PUIG knows how important it is to help achieve the best aerodynamic coefficient of our screens. For this reason we have developed these deflectors compatible with PUIG screens and OEM designed to fit perfectly with its design and assembly, without fitting problems or unwanted gaps.



**F** Dark Smoke

**N** Black

**H** Smoke

**W** Clear



# UPPER DEFLECTORS



\* Check availability for motorcycle models at [www.puig.tv](http://www.puig.tv) typing in the searching window:

**UPPER DEFLECTOR**



**IMPACT  
RESISTANT**



**PMMA  
ACRYLIC**



**AERODYNAMIC**

**F** Dark Smoke

**H** Smoke

**W** Clear



REF. 9847



**Puig**  
DEFLECTORS

OEM  
WITHOUT DEFLECTOR



The deflectors adapt ideally to the lines of the motorcycle thanks to their design and the quality of their finishes, allowing the air flow to be diverted away from the legs and improving riding comfort.



# WINDSHIELD NEW GENERATION



\* Check availability for motorcycle models at [www.puig.tv](http://www.puig.tv) typing in the searching window:

**NEW GENERATION**



AERODYNAMIC

- |               |              |          |         |
|---------------|--------------|----------|---------|
| A Blue        | G Yellow     | N Black  | V Green |
| C Carbon look | H Smoke      | R Red    | W Clear |
| F Dark Smoke  | J Matt black | T Orange |         |



**VIRTUAL WIND TUNNEL TESTED**

- Lower pressure
- Max. pressure

- Lower pressure
- Max. pressure



Wind pressure without Windshield Naked  
New Generation Puig.

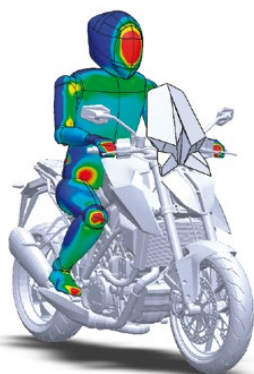

Wind pressure with Windshield Naked  
New Generation Puig.

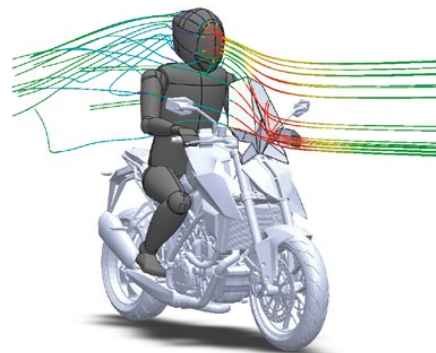

Improve aerodynamics and  
windprotection.

At PUIG, depending on the model, we apply a silkscreen or not on our windshields to hide unattractive parts of the motorcycle.



**F900R**

Serigraphed windscreen brilliant in the interior

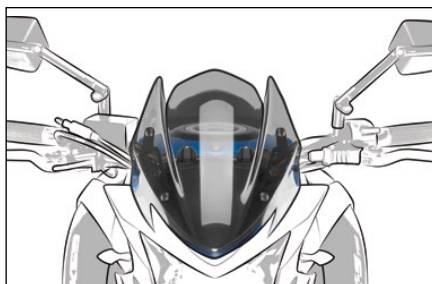

**GSX-S750**

Windscreen without silkscreened.



**Z900**

Silkscreened windscreen in black matt on the outside.

**PUIG HAS THREE NEW GENERATION MODELS:**

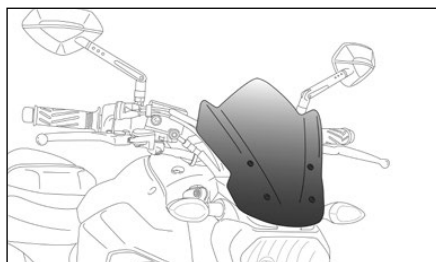

**SPORT**

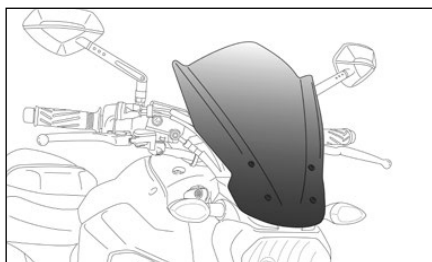

**TOURING**

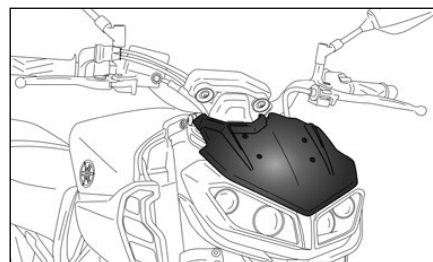

**SPORT PLUS**

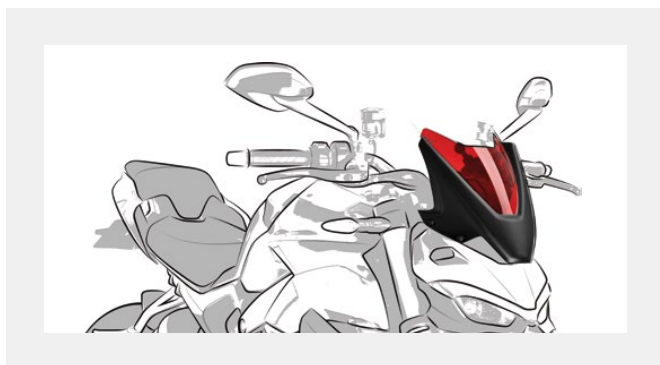

The shape of the windshield may vary according to the motorcycle model, **please visit our website.**

If you are searching for more protection, Puig offers multi-adjustable visors which can be mounted on oem or our windshields. Please check our catalog on **page 82-89** or our site **www.puig.tv** to see the recommended visor for your motorcycle.

# WINDSHIELD FLANKER



\* Check availability for motorcycle models at [www.puig.tv](http://www.puig.tv) typing in the searching window:

**FLANKER**



MODEL	REF.	F H N W
FLANKER UNIVERSAL HANDLEBARS 22/29 mm.	20334	(*)

(\*) Check price with your distributor.

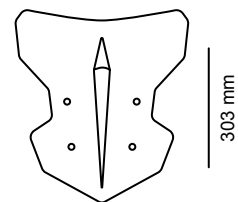

270 mm

303 mm

2 FIXATION POINTS

- F Dark Smoke
- H Smoke
- N Black
- W Clear

# WINDSHIELD RAFALE



\* Check availability for motorcycle models at [www.puig.tv](http://www.puig.tv) typing in the searching window:  
**RAFALE**



<b>TÜV</b>	<b>ABE</b> 38188	<b>TYP</b> CS18	<b>PMMA</b> ACRYLIC
------------	---------------------	--------------------	------------------------

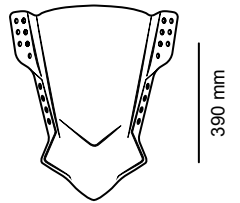

MODEL	REF.	AFGHNRTVW
RAFALE UNIVERSAL HANDLEBARS 22/29 mm.	5881	(*)

(\*) Check price with your distributor.

355 mm  
390 mm  
2 FIXATION POINTS

- |  |  |  |  |
|--|--|--|--|
| <span style="color: blue;">■</span> A Blue       | <span style="color: yellow;">■</span> G Yellow   | <span style="color: black;">■</span> N Black | <span style="color: orange;">■</span> T Orange   |
| <span style="color: gray;">■</span> F Dark Smoke | <span style="color: lightgray;">■</span> H Smoke | <span style="color: red;">■</span> R Red     | <span style="color: green;">■</span> V Green   |
|  |  |  | <span style="border: 1px solid black; display: inline-block; width: 10px; height: 10px;"></span> W Clear |



# WINDSHIELD BAT



\* Check availability for motorcycle models at [www.puig.tv](http://www.puig.tv) typing in the searching window:

**BAT**



**TÜV**

**ABE**  
38188

**TYP**  
CS19

**PC**  
POLYCARBONATE

## MODEL

BAT UNIVERSAL HANDLEBARS 22/29 mm.

## REF.

8088

## F H W

(\*)

## VISOR

RECOMMENDED MULTI-ADJUSTABLE VISOR FIXED WITH SCREWS

## REF.

20763

## H W

(\*)

RECOMMENDED CLIP-ON MULTI-ADJUSTABLE VISOR

20764

(\*)

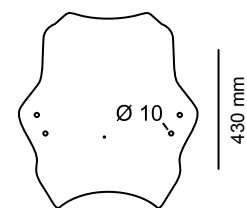

390 mm

430 mm

2 FIXATION POINTS

**F** Dark Smoke

**H** Smoke

**W** Clear

(\*) Check price with your distributor.

# WINDSHIELD MITO



\* Check availability for motorcycle models at [www.puig.tv](http://www.puig.tv) typing in the searching window:

**MITO**



**TÜV**

**ABE**  
38007

**TYP**  
WS22

**PMMA**  
ACRYLIC

## MODEL

MITO UNIVERSAL HANDLEBARS 22/29 mm.

**REF. F H N W**

20702 (\*)

## VISOR

RECOMMENDED MULTI-ADJUSTABLE VISOR FIXED WITH SCREWS

**REF. H W**

6007 (\*)

RECOMMENDED CLIP-ON MULTI-ADJUSTABLE VISOR

6319 (\*)

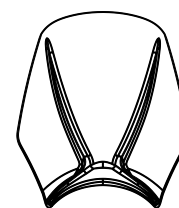

320 mm

285 mm

2 FIXATION POINTS

**F** Dark Smoke  
 **H** Smoke

**N** Black  
 **W** Clear

(\*) Check price with your distributor.

# WINDSHIELD UP&DOWN



\* Check availability for motorcycle models at [www.puig.tv](http://www.puig.tv) typing in the searching window:

**UP DOWN**

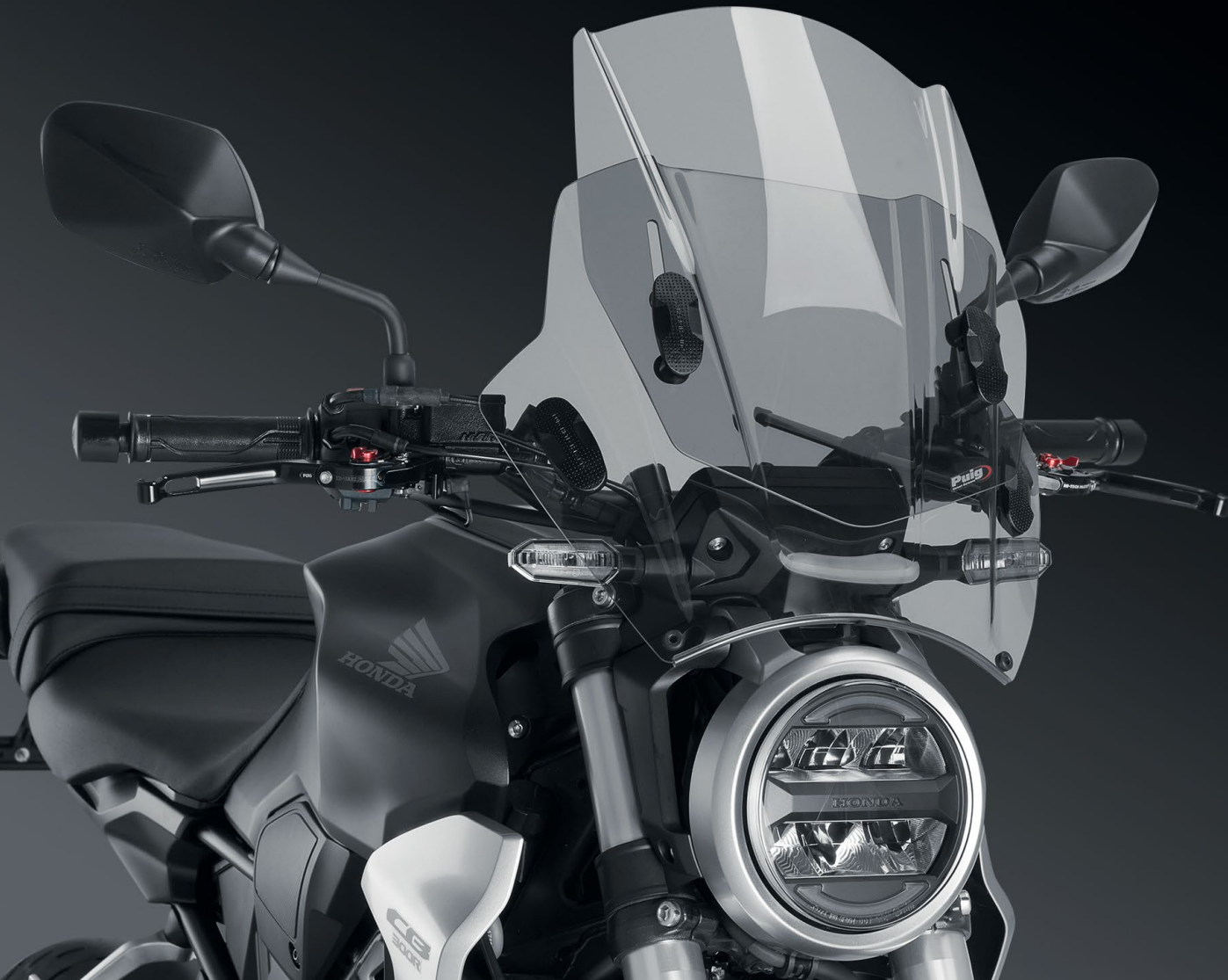

**TÜV**

**ABE**  
38007

**TYP**  
WS17

**PMMA**  
ACRYLIC

## MODEL

UP&DOWN UNIVERSAL HANDLEBARS 22/29 mm.

REF.

2193

H W

(\*)

## VISOR

RECOMMENDED MULTI-ADJUSTABLE VISOR FIXED WITH SCREWS

REF.

20763

H W

(\*)

RECOMMENDED CLIP-ON MULTI-ADJUSTABLE VISOR

REF.

20764

H W

(\*)

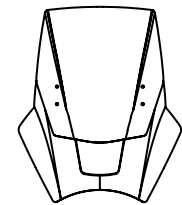

450-505 mm

410 mm

2 FIXATION POINTS

- H Smoke
- W Clear

(\*) Check price with your distributor.



# WINDSHIELD TREND



\* Check availability for motorcycle models at [www.puig.tv](http://www.puig.tv) typing in the searching window:

**TREND**



MODEL	REF.	A H F N
TREND UNIVERSAL HANDLEBARS 22/29 mm.	5022	(*)
VISOR	REF.	H W
RECOMMENDED MULTI-ADJUSTABLE VISOR FIXED WITH SCREWS	20763	(*)
RECOMMENDED CLIP-ON MULTI-ADJUSTABLE VISOR	20764	(*)

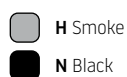
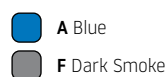
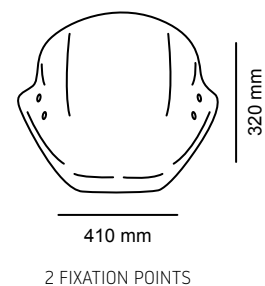

(\*) Check price with your distributor.

# WINDSHIELD TOURING II



\* Check availability for motorcycle models at [www.puig.tv](http://www.puig.tv) typing in the searching window:

**TOURING II**



**TÜV**

**ABE**  
38007

**TYP**  
WS21

**PMMA**  
ACRYLIC

## MODEL

TOURING II UNIVERSAL HANDLEBARS 22/29 mm.

## REF.

5267

## H

(\*)

## W

(\*)

## VISOR

RECOMMENDED MULTI-ADJUSTABLE VISOR FIXED WITH SCREWS

## REF.

20763

## H

(\*)

## W

(\*)

RECOMMENDED CLIP-ON MULTI-ADJUSTABLE VISOR

20764

(\*)

(\*)

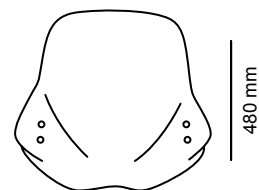

535 mm

480 mm

2 FIXATION POINTS

- H Smoke
- W Clear

(\*) Check price with your distributor.

# WINDSHIELD NAKED



\* Check availability for motorcycle models at [www.puig.tv](http://www.puig.tv) typing in the searching window:

**NAKED**



MODEL	REF.	A F H N
UNIVERSAL	0869	(*)

Do not use loctite type glue for screws, since it will react with the plastic by cracking it.

**Thickness:** 3 mm.

Optimum mounting for headlights  $\varnothing$  200 mm.

A Blue

H Smoke

F Dark Smoke

N Black

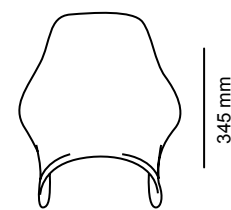

320 mm

345 mm

2 FIXATION POINTS

(\*) Check price with your distributor.



# WINDSHIELD RAPTOR



\* Check availability for motorcycle models at [www.puig.tv](http://www.puig.tv) typing in the searching window:

**RAPTOR**



MODEL	REF.	A F H N R W
UNIVERSAL	0013	(*)

Do not use loctite type glue for screws, since it will react with the plastic by cracking it.

**Thickness:** 3 mm.

Optimum mounting for headlights  $\varnothing$  200 mm.

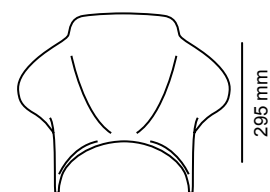

355 mm

295 mm

2 FIXATION POINTS



(\*) Check price with your distributor.

# WINDSHIELD COCKPIT



\* Check availability for motorcycle models at [www.puig.tv](http://www.puig.tv) typing in the searching window:

**COCKPIT**



**TÜV**

**ABE**  
38188

**TYP**  
CS4

**PMMA**  
ACRYLIC

## MODEL

UNIVERSAL

## REF.

1480

## A F G H N R W

(\*)

Do not use loctite type glue for screws, since it will react with the plastic by cracking it.

**Thickness:** 3 mm.

Optimum mounting for headlights  $\varnothing$  200 mm.

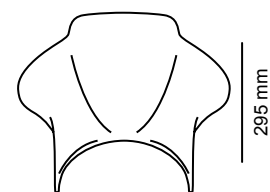

355 mm

295 mm

2 FIXATION POINTS

**A** Blue

**G** Yellow

**N** Black

**F** Dark Smoke

**H** Smoke

**R** Red

**W** Clear

(\*) Check price with your distributor.

# WINDSHIELD WAVE



\* Check availability for motorcycle models at [www.puig.tv](http://www.puig.tv) typing in the searching window:

**WAVE**



MODEL	REF.	A F H N R
UNIVERSAL	2208	(*)

Do not use loctite type glue for screws, since it will react with the plastic by cracking it.

**Thickness:** 3 mm.

Optimum mounting for headlights Ø 200 mm.

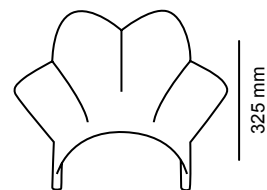

375 mm

325 mm

2 FIXATION POINTS

- A Blue
- H Smoke
- F Dark Smoke
- N Black
- R Red

(\*) Check price with your distributor.



# WINDSHIELD WINDY



\* Check availability for motorcycle models at [www.puig.tv](http://www.puig.tv) typing in the searching window:

**WINDY**



MODEL	REF.	A F H N R W
UNIVERSAL	1482	(*)

Do not use loctite type glue for screws, since it will react with the plastic by cracking it.

**Thickness:** 3 mm.

Optimum mounting for headlights  $\varnothing$  200 mm.

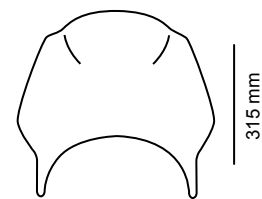

355 mm

315 mm

2 FIXATION POINTS



(\*) Check price with your distributor.

# WINDSHIELD VISION



\* Check availability for motorcycle models at [www.puig.tv](http://www.puig.tv) typing in the searching window:

**VISION**



MODEL	REF.	A F H N W
UNIVERSAL SEMI-FAIRING CARBON LOOK	003CX	(*)
UNIVERSAL SEMI-FAIRING BLACK	003NX	(*)

Do not use loctite type glue for screws, since it will react with the plastic by cracking it.

**Thickness:** 3 mm.

Optimum mounting for headlights Ø 200 mm.

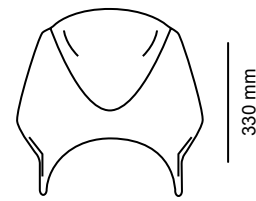

310 mm

330 mm

2 FIXATION POINTS

SEMI-FAIRING CARBON LOOK

CA Blue

CF Dark smoke

CH Smoke

CN Black

CW Clear

SEMI-FAIRING BLACK

NA Blue

NF Dark smoke

NH smoke

NN Black

NW Clear

# WINDSHIELD TOP



\* Check availability for motorcycle models at [www.puig.tv](http://www.puig.tv) typing in the searching window:

**TOP**



**TÜV**

**ABE**  
38188

**TYP**  
CS5

**PMMA**  
ACRYLIC

MODEL	REF.	H N
UNIVERSAL	1309	(*)

Do not use loctite type glue for screws, since it will react with the plastic by cracking it.

**Thickness:** 3 mm.

Optimum mounting for headlights  $\varnothing$  200 mm.

H Smoke

N Black

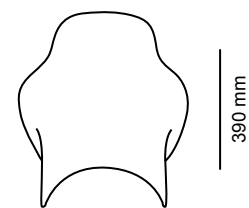

355 mm

390 mm

2 FIXATION POINTS

(\*) Check price with your distributor.



# WINDSHIELD PLUS



\* Check availability for motorcycle models at [www.puig.tv](http://www.puig.tv) typing in the searching window:

**PLUS**



MODEL	REF.	F H
UNIVERSAL	4620	(*)

Do not use loctite type glue for screws, since it will react with the plastic by cracking it.

**Thickness:** 3 mm.

Optimum mounting for headlights Ø 200 mm.

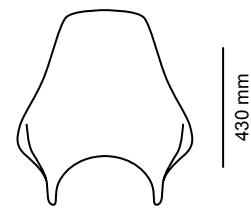

405 mm

430 mm

2 FIXATION POINTS

- F** Dark Smoke
- H** Smoke

(\*) Check price with your distributor.

# WINDSHIELD CUSTOM I



\* Check availability for motorcycle models at [www.puig.tv](http://www.puig.tv) typing in the searching window:

**CUSTOM I**



MODEL	REF.	H W
UNIVERSAL HANDLEBARS 22/26 mm. FORKS 38/42 mm.	0840	(*)
VISOR	REF.	H W
RECOMMENDED MULTI-ADJUSTABLE VISOR FIXED WITH SCREWS	6007	(*)
RECOMMENDED CLIP-ON MULTI-ADJUSTABLE VISOR	6319	(*)

**Thickness:** 3 mm.

- H Smoke
- W Clear

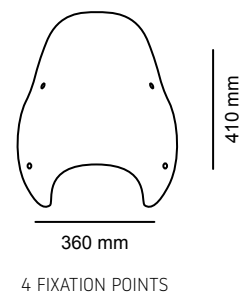

(\*) Check price with your distributor.

# WINDSHIELD CUSTOM II



\* Check availability for motorcycle models at [www.puig.tv](http://www.puig.tv) typing in the searching window:

**CUSTOM II**



MODEL	REF.	H W
UNIVERSAL HANDLEBARS 22/29 mm.	0336	(*)
VISOR	REF.	H W
RECOMMENDED MULTI-ADJUSTABLE VISOR FIXED WITH SCREWS	6007	(*)
RECOMMENDED CLIP-ON MULTI-ADJUSTABLE VISOR	6319	(*)

**Thickness:** 3 mm.

- H Smoke  
 W Clear

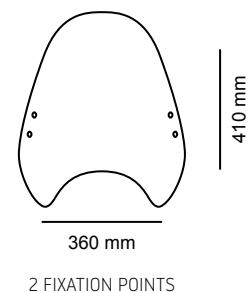

(\*) Check price with your distributor.



# WINDSHIELD RANGER



\* Check availability for motorcycle models at [www.puig.tv](http://www.puig.tv) typing in the searching window:

**RANGER**



**TÜV**

**ABE**  
38007

**TYP**  
WS14

**PMMA**  
ACRYLIC

MODEL	REF.	H
UNIVERSAL HANDLEBARS 22/26 mm. FORKS 38/42 mm.	0328	(*)
VISOR	REF.	H
RECOMMENDED MULTI-ADJUSTABLE VISOR FIXED WITH SCREWS	5853	(*)
RECOMMENDED CLIP-ON MULTI-ADJUSTABLE VISOR	6375	(*)

Thickness: 3 mm.

H Smoke

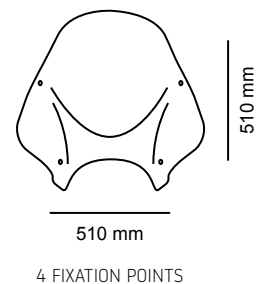

4 FIXATION POINTS

(\*) Check price with your distributor.

# WINDSHIELD TOURING I



\* Check availability for motorcycle models at [www.puig.tv](http://www.puig.tv) typing in the searching window:

**TOURING I**



**TÜV**

**ABE**  
38007

**TYP**  
WS21

**PMMA**  
ACRYLIC

MODEL	REF.	W
UNIVERSAL HANDLEBARS 22/29 mm.	0856	(*)
VISOR	REF.	W
RECOMMENDED MULTI-ADJUSTABLE VISOR FIXED WITH SCREWS	20763	(*)
RECOMMENDED CLIP-ON MULTI-ADJUSTABLE VISOR	20764	(*)

**Thickness:** 3 mm.

**W** Clear

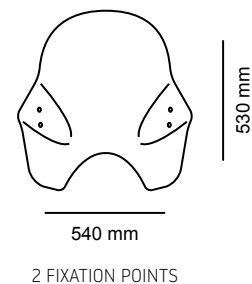

(\*) Check price with your distributor.

# WINDSHIELD ROADSTER



\* Check availability for motorcycle models at [www.puig.tv](http://www.puig.tv) typing in the searching window:

**ROADSTER**



**TÜV**

**ABE**  
38188

**TYP**  
CS2

**PC**  
POLYCARBONATE

MODEL	REF.	H W
UNIVERSAL A	0444	(*)
UNIVERSAL B	0131	(*)
UNIVERSAL C	5932	(*)

Fixings to the fork bars.

Fixations on light screws.

Fixings to the handle of 22/26 mm.

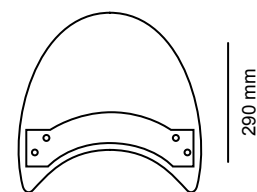

260 mm

290 mm

2 FIXATION POINTS

- H Smoke
- W Clear

(\*) Check price with your distributor.



# WINDSHIELD CHOPPER



\* Check availability for motorcycle models at [www.puig.tv](http://www.puig.tv) typing in the searching window:

**CHOPPER**



MODEL	REF.	W
UNIVERSAL HANDLEBARS 22/26 mm.	0854	(*)
DEFLECTOR	REF.	H W
RECOMMENDED DEFLECTOR	4717	(*)

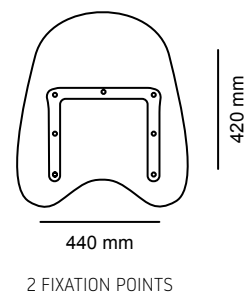

- H Smoke
- W Clear

(\*) Check price with your distributor.

# WINDSHIELD HIGHWAY



\* Check availability for motorcycle models at [www.puig.tv](http://www.puig.tv) typing in the searching window:

**HIGHWAY**



MODEL	REF.	W
UNIVERSAL HANDLEBARS 22/26 mm.	0129	(*)
DEFLECTOR	REF.	H W
RECOMMENDED DEFLECTOR	4717	(*)

Easy-mounting windshield through 2 handlebar clamps.

For a more demanding fixation we recommend our fairing models of 4 fixing points.

- H Smoke
- W Clear

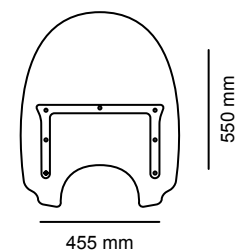

2 FIXATION POINTS

(\*) Check price with your distributor.

# WINDSHIELD DAYTONA IV



\* Check availability for motorcycle models at [www.puig.tv](http://www.puig.tv) typing in the searching window:

**DAYTONA IV**



**TÜV**

**ABE**  
38007

**TYP**  
WS15

**PMMA**  
ACRYLIC

MODEL	REF.	W
UNIVERSAL HANDLEBARS 22/26 mm.	2003	(*)
DEFLECTOR	REF.	H W
RECOMMENDED DEFLECTOR	4717	(*)

Easy-mounting windshield through 2 handlebar clamps

For a more demanding fixation we recommend our fairing models of 4 fixing points.

- H Smoke
- W Clear

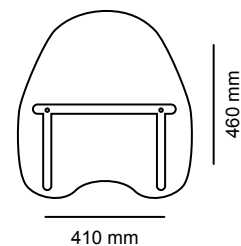

2 FIXATION POINTS

(\*) Check price with your distributor.



# WINDSHIELD DAYTONA III



\* Check availability for motorcycle models at [www.puig.tv](http://www.puig.tv) typing in the searching window:

**DAYTONA III**



**TÜV**

**ABE**  
38007

**TYP**  
WS16

**PMMA**  
ACRYLIC

MODEL	REF.	W
UNIVERSAL HANDLEBARS 22/26 mm.	1984	(*)
DEFLECTOR	REF.	H W
RECOMMENDED DEFLECTOR	4717	(*)

Easy-mounting windshield through 2 handlebar clamps

For a more demanding fixation we recommend our fairing models of 4 fixing points.

- H** Smoke
- W** Clear

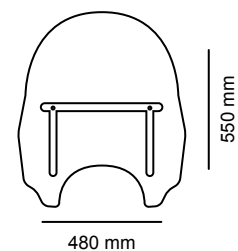

2 FIXATION POINTS

(\*) Check price with your distributor.

# WINDSHIELD AMERICA I



\* Check availability for motorcycle models at [www.puig.tv](http://www.puig.tv) typing in the searching window:

**AMERICA I**

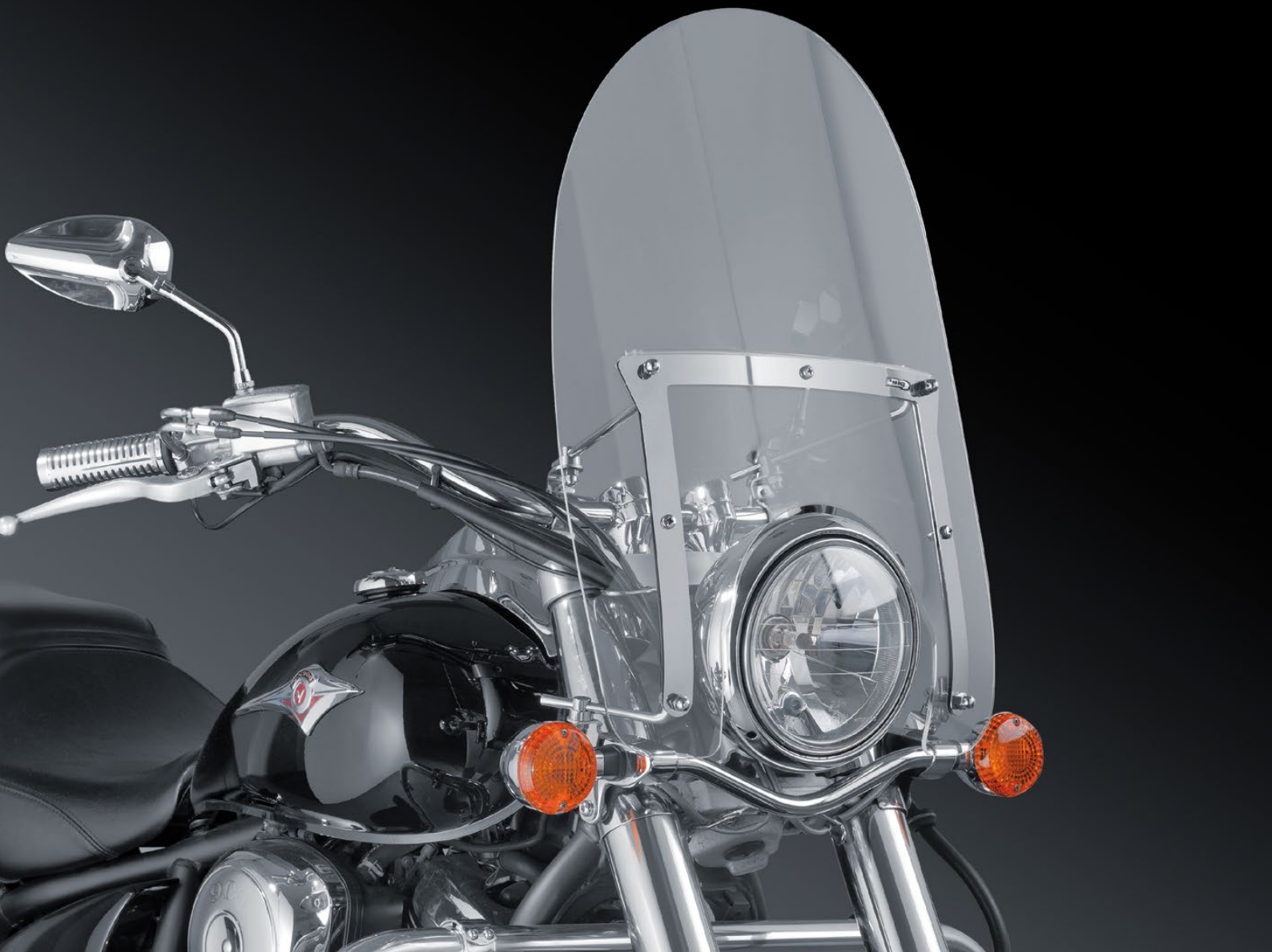

**TÜV**

**ABE**  
38007

**TYP**  
WS10

**PMMA**  
ACRYLIC

MODEL	REF.	W
UNIVERSAL	0867	(*)
DEFLECTOR	REF.	H W
RECOMMENDED DEFLECTOR	4717	(*)

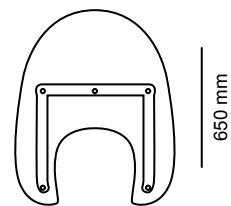

455 mm

650 mm

4 FIXATION POINTS

- H Smoke
- W Clear

(\*) Check price with your distributor.

# WINDSHIELD AMERICA II



\* Check availability for motorcycle models at [www.puig.tv](http://www.puig.tv) typing in the searching window:

**AMERICA II**



**TÜV**

**ABE**  
38007

**TYP**  
WS9

**PMMA**  
ACRYLIC

MODEL	REF.	W
UNIVERSAL	0319	(*)
DEFLECTOR	REF.	H W
RECOMMENDED DEFLECTOR	4717	(*)

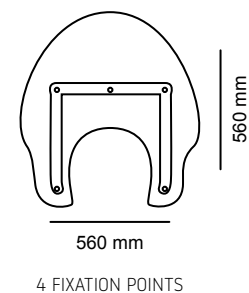

- H Smoke
- W Clear

(\*) Check price with your distributor.



# WINDSHIELD AMERICA III



\* Check availability for motorcycle models at [www.puig.tv](http://www.puig.tv) typing in the searching window:

**AMERICA III**



MODEL	REF.	W
UNIVERSAL	1129	(*)
DEFLECTOR	REF.	H W
RECOMMENDED DEFLECTOR	4717	(*)

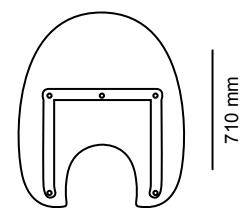

580 mm

4 FIXATION POINTS

- H Smoke
- W Clear

(\*) Check price with your distributor.





# SEMI-FAIRINGS



\* Check availability for motorcycle models at [www.puig.tv](http://www.puig.tv) typing in the searching window:

**SEMIFAIRINGS**



## SEMI-FAIRING

 C Carbon look

 J Matt black

 N Black

## SCREEN

 F Dark Smoke

 H Smoke

 N Black

 W Clear





BMW R NINE T  
(REF. 9160F)

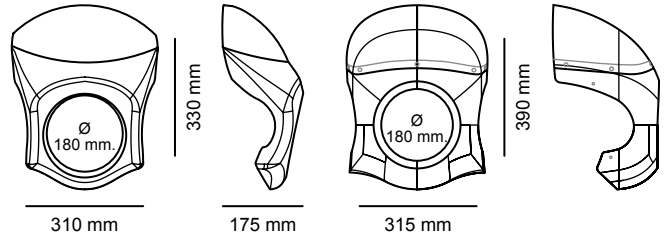

CV7 VARIANT 2  
REF.9554/9516

CV7 VARIANT 1

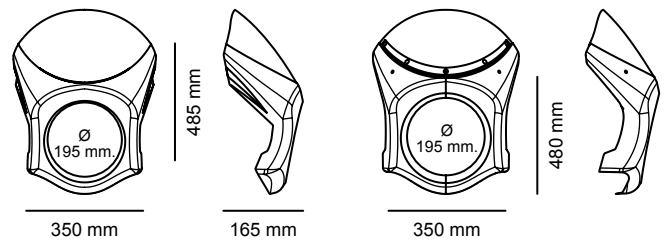

CV8 VARIANT 2  
REF.9553/9515

CV8 VARIANT 1

**MODEL**

	<b>REF.</b>	<b>F H N W</b>
UNIVERSAL BLACK SEMI-FAIRING Ø 195 mm - CV8 Variante 2	9553	(*)
UNIVERSAL CARBON LOOK SEMI-FAIRING Ø 195 mm - CV8 Variante 2	9515	(*)
UNIVERSAL BLACK SEMI-FAIRING Ø 180 mm - CV7 Variante 2	9554	(*)
UNIVERSAL CARBON LOOK SEMI-FAIRING Ø 180 mm. - CV7 Variante 2	9516	(*)

**SPARES**

	<b>REF.</b>	<b>F H N W</b>	<b>N</b>	<b>J</b>	<b>C</b>
SEMI-FAIRING Ø 195 mm - CV8 Variante 1	10647			(*)	(*)
SEMI-FAIRING Ø 195 mm - CV8 Variante 2	9230			(*)	(*)
SEMI-FAIRING Ø 180 mm - CV7 Variante 1	10522		(*)		(*)
SEMI-FAIRING Ø 180 mm - CV7 Variante 2	9231			(*)	(*)
SCREEN Ø 195 mm.	9196	(*)			
SCREEN Ø 180 mm.	9872	(*)			
UNIVERSAL SUPPORTS SEMI-FAIRING Ø 195 mm.	9978N		(*)		
UNIVERSAL SUPPORTS SEMI-FAIRING Ø 180 mm.	9979N		(*)		

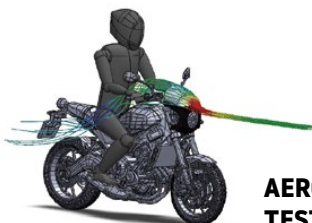

**AERODYNAMIC TEST**

(\*) Check price with your distributor.

# RETROVISIONS



\* Check availability for motorcycle models at [www.puig.tv](http://www.puig.tv) typing in the searching window:





**RETROVISIONS**



## SEMI-FAIRING

-  C Carbon look
-  J Matt black

## SCREEN

-  F Dark Smoke
-  H Smoke
-  N Black
-  W Clear



DUCATI SCRAMBLER  
(REF. 7652)

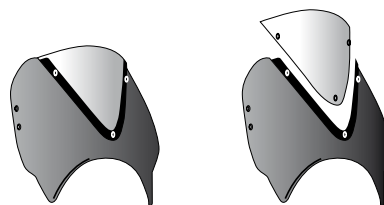
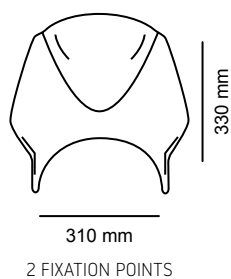

The retrovision is formed by a opaque base (black or carbon look) and a screen in light, smoke, dark smoke, black or clear.

MODEL	REF.
UNIVERSAL RETROVISION	SEE PAGE 110

SPARES	REF.	F H N W
SCREEN	1517	(*)



**AERODYNAMIC TEST**

(\*) Check price with your distributor.



# FRONTAL PLATE (IN ALUMINIUM)



\* Check availability for motorcycle models at [www.puig.tv](http://www.puig.tv) typing in the searching window:

**ALU PLATE**



- N Black
- P Aluminium

May be used as small screen for wind protection or as a number plate. It carries a set of universal supports or specific supports for selected models.



AERODYNAMIC

REF. 9807N

REF. 9807P

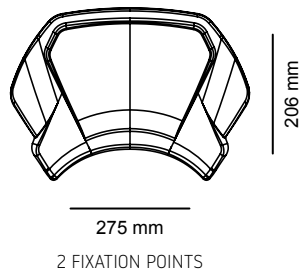

**MODEL**

	REF.	P	N
UNIVERSAL FRONT PLATE - FIXING TO FORKS	3592	(*)	(*)
UNIVERSAL FRONTAL PLATE - FIXING TO SUPPORTS OF THE FARE	3593	(*)	(*)

**SPARES**

	REF.	P	N
ALUMINIUM FRONTAL PLATE	9807	(*)	(*)
UNIVERSAL SUPPORTS	9977		(*)

(\*) Check price with your distributor.



**AERODYNAMIC TEST**

**01235  
46789**



NOTE: Adhesive numbers compatible with plates see page 478.

# FRONTAL PLATE (IN ABS)



\* Check availability for motorcycle models at [www.puig.tv](http://www.puig.tv) typing in the searching window:

**ABS PLATE**



 C Carbon look

 J Matt black

Double function: Deflects wind and number plate.  
Available with universal supports or specific for selected motorcycles.





AERODYNAMIC

REF. 9229C



FRONTAL PLATE

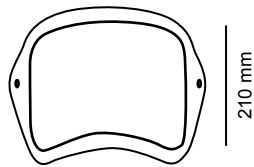

250 mm  
2 FIXATION POINTS

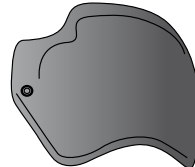

ASYMETRIC FRONTAL PLATE  
(Only REF. 9177, 9522)

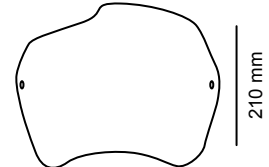

250 mm  
2 FIXATION POINTS

MODEL	REF.	J	C
UNIVERSAL FRONT PLATE - FIXING TO FORKS	3590	(*)	(*)
UNIVERSAL FRONTAL PLATE - FIXING TO THE LIGHT SUPPORT	3591	(*)	(*)

SPARES	REF.	J	C	N
FRONTAL PLATE	9229	(*)	(*)	
UNIVERSAL SUPPORTS	9977			(*)

(\*) Check price with your distributor.

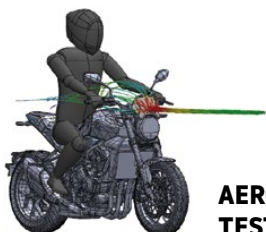

**AERODYNAMIC TEST**

**01235  
46789**



NOTE: Adhesive numbers compatible with plates see page 478.

# HIGH-ROAD SCREEN



\* Check availability for motorcycle models at [www.puig.tv](http://www.puig.tv) typing in the searching window:

**HIGHROAD**



## SPORT

- F Dark Smoke
- H Smoke

- N Black
- W Clear

## TOURING

- F Dark Smoke
- H Smoke

- W Clear

PMMA  
ACRYLICUV  
RESISTANTROUND  
EDGE

AERODYNAMIC



REF. 21236W



REF. 21340F



Designed to offer better aerodynamic protection to Custom and Cruiser style motorcycles that have the original front fairing. With elegant and sober shapes, it adapts perfectly to the attractive aesthetics of this type of motorcycle.

Two versions are available, Sport and Touring, with 223 mm. and 323 mm. height respectively, so that each user can choose the one that best suits their riding needs.

Thanks to its design study developed with wind tunnel technology, the High-Road screens are more inclined to bring them closer to the driver, cleanly diverting the frontal air stream that would impact the rider directly, eliminating annoying turbulence and vibrations on the helmet. It will significantly increase riding comfort and reduce fatigue to enjoy longer rides.

**NOTE:** To replace or change the screws of the windscreen, **please check page 72.**



# FURY SEMIFARING



\* Check availability for motorcycle models at [www.puig.tv](http://www.puig.tv) typing in the searching window:

**FURY**



## SEMI-FAIRING

- J Matt black
- N Gloss Black

## SCREEN

- F Dark Smoke
- H Smoke

- N Black
- W Clear

TÜV ABE 39524 TYP CV13 PMMA ACRYLIC ABS

4,5 mm.

**NEW!**



REF. 21581F

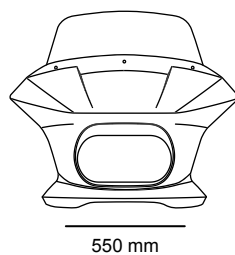
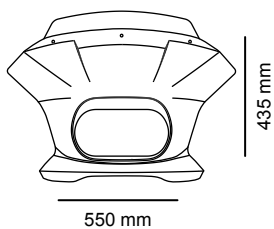

Made specifically for the Harley-Davidson Sportster S, its Batwing style design, inspired by the sharp snout of white sharks, sports a very marked horizontal line that highlights a practically flat upper area that integrates perfectly with the tank and the set of the motorcycle. Therefore, it is ideal for those riders who seek to combine aesthetics and functionality in equal parts.

With the installation of the Fury semi fairing, the amount of air that would impact the rider is reduced, diverting the air cleanly to the sides, avoiding annoying turbulence, which considerably increases riding comfort and reduces fatigue.



# MIRAGE SEMI-FAIRINGS



\* Check availability for motorcycle models at [www.puig.tv](http://www.puig.tv) typing in the searching window:

**MIRAGE**



## SEMI-FAIRING

- J Matt black
- N Gloss Black

## SCREEN

- F Dark Smoke
- H Smoke
- W Clear



TÜV

ABE  
39524TYP  
CV12PMMA  
ACRYLIC

ABS

ROUND  
EDGE

4,5 mm.

AERODYNAMIC



Ø DIAMETER  
175 mm.

REF. 21331F

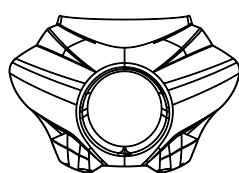

530 mm

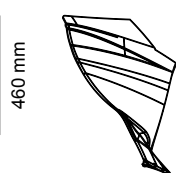

460 mm

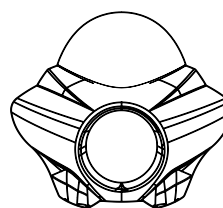

560 mm



530 mm

The semifairing Mirage is composed by a black plastic fairing of different sizes and a screen manufactured in clear or smoked PMMA. The user can choose between two different measures: Sport, for those who look for a more sporty look to their motorcycle, and touring for those who prioritize riding protection. The fairing must be installed by the rider with the screw kit.



# ANARCHY SEMI-FAIRINGS



\* Check availability for motorcycle models at [www.puig.tv](http://www.puig.tv) typing in the searching window:

**ANARCHY**



## SEMI-FAIRING

- J Matt black
- N Gloss Black

TÜV

ABE  
91524TYP  
CV9PMMA  
ACRYLIC

ABS

ROUND  
EDGE

AERODYNAMIC



Ø DIAMETER  
155 mm.

REF. 21081N

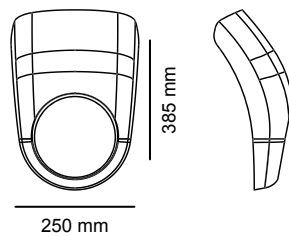

CV9 Variant 1

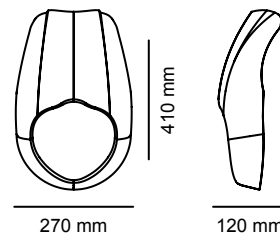

CV9 Variant 2

The new Anarchy semifairing is the perfect combination of sportness and protection for your motorcycle, since with the different measures of the semifairing, it does not only get the extreme look you are looking for, it also protects the motorcycle and the rider.

Its assembly is an easy task that is accompanied by an assembly kit with instructions and screws necessary for its correct installation.



**AERODYNAMIC  
TEST**



# DARK NIGHT SEMI-FAIRINGS



\* Check availability for motorcycle models at [www.puig.tv](http://www.puig.tv) typing in the searching window:

**DARK NIGHT**



## SEMI-FAIRING

- J Matt black
- N Gloss Black

## SCREEN

- F Dark Smoke
- H Smoke



AERODYNAMIC



Ø DIAMETER  
150 mm.

REF. 21095H

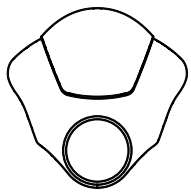

460 mm

CV10 Variant 1

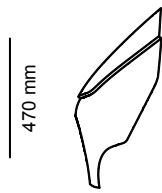

470 mm

155 mm

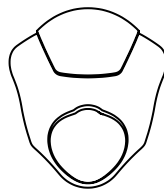

430 mm

CV10 Variant 2



495 mm

175 mm

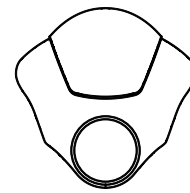

460 mm

CV10 Variant 3

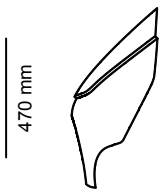

470 mm

155 mm

Sport design, black brightness finish with a clear smoked screen, its perfect measures, 47 cm. high and 46 cm. wide, they will guarantee you the best riding experience. This semifarng adapts to the headlight, either rounded or in a way as is the case of the Vulcan S.

The piece is delivered with an instructions assembly kit and all the necessary screws for its installation to be fast and simple.



**AERODYNAMIC  
TEST**

# BATWING SML



\* Check availability for motorcycle models at [www.puig.tv](http://www.puig.tv) typing in the searching window:

**BATWING**



## SEMI-FAIRING

- J Matt black
- N Gloss Black

## SCREEN

- H Smoke
- W Clear





REF. 21048W



REF. 21049W

**SML TOURING**

**SML SPORT**

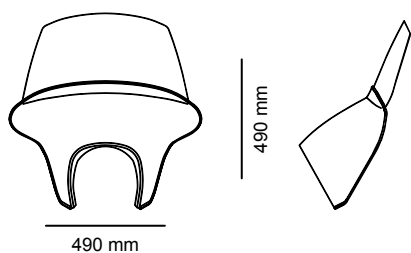

CV11 Variant 1

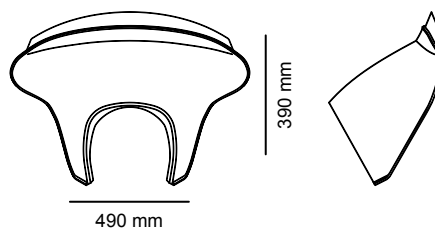

CV11 Variant 2

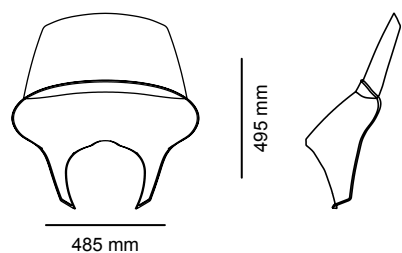

CV11 Variant 4

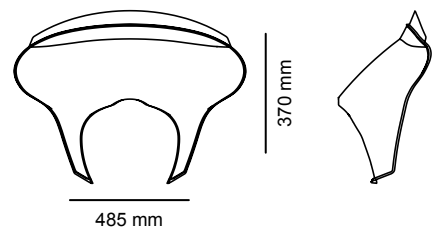

CV11 Variant 3

Batwing SML is composed by a black plastic fairing of different sizes and a screen manufactured in clear or smoked PMMA. The user can choose between two different measures: Sport, for those who look for a more sporty look to their motorcycle, and touring for those who prioritize riding protection. The fairing must be installed by the rider with the screw kit.

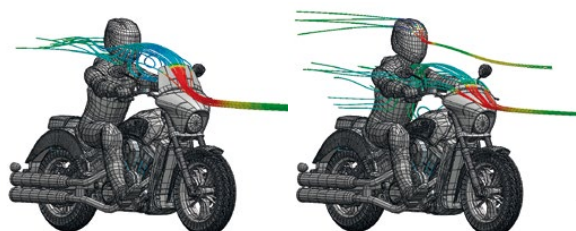

**AERODYNAMIC TEST**

# WINDSHIELD GTS SPORT



\* Check availability for motorcycle models at [www.piaggio.tv](http://www.piaggio.tv) typing in the searching window:

**GTS SPORT**



AERODYNAMIC

The new GTS Sport Windshield is designed to enhance aerodynamic capacity, provide greater protection and provide that sport character that you are looking for your Piaggio Vespa GTS.

Made of high-end CN acrylic material, the GTS Sport Windscreen will become your best ally against inclement weather and gusty winds, as well as being strong and resistant to possible impact or splashes during the route.



400 mm

230 mm

4 FIXATION POINTS

H Smoke

W Clear

# WINDSHIELD GTS TOURING



\* Check availability for motorcycle models at [www.piaggio.tv](http://www.piaggio.tv) typing in the searching window:

**GTS TOURING**



PMMA  
ACRYLIC

ROUND  
EDGE



TÜV

ABE  
38120

TYP  
GTS  
TOURING

AERODYNAMIC

The new GTS Touring Windshield is designed to improve the riding experience of your Piaggio Vespa GTS and protect you from gusts of wind on days with adverse weather conditions.

Thanks to its rounded and elegant lines, and its availability in a clear and light smoked finish, the GTS Touring Windscreen will not only perfectly adapt to the aesthetic line of your motorcycle, but will also reinforce that neo-retro character that this iconic model possess.

H Smoke

W Clear

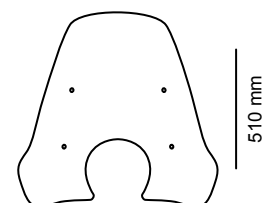

630 mm

4 FIXATION POINTS



# WINDSHIELD CITY TOURING



\* Check availability for motorcycle models at [www.puig.tv](http://www.puig.tv) typing in the searching window:

**CITY TOURING**



MODEL	REF.	H
UNIVERSAL (REARVIEW MIRROR M8)	0572	(*)

City Touring is manufactured in 3mm polycarbonate and with a smoky finish, it will show its strength through gusty winds giving you a feeling of quality and maximum comfort on the road.

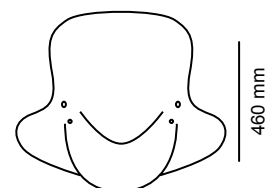

560 mm

2 FIXATION POINTS

H Smoke

(\*) Check price with your distributor.

# WINDSHIELD TRAFIC



\* Check availability for motorcycle models at [www.puig.tv](http://www.puig.tv) typing in the searching window:

**TRAFIC**



MODEL	REF.	H W
UNIVERSAL	4873	(*)

An urban and cosmopolitan design, with great protection against wind and cold, but with a lower screen design that allows a better aerodynamic condition. Made of 3mm polycarbonate.

H Smoke

W Clear

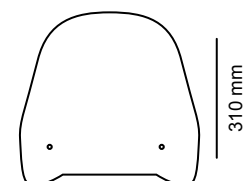

370 mm

2 FIXATION POINTS

(\*) Check price with your distributor.

# WINDSHIELD URBAN



\* Check availability for motorcycle models at [www.puig.tv](http://www.puig.tv) typing in the searching window:

**URBAN**



MODEL	REF.	H W
UNIVERSAL	7599	(*)

The Urban windshield is the latest development by Puig in scooter windshields and has been designed to satisfy the needs of customers who demanded a higher product for this segment of motorcycles. This new windshield created by Puig has a cosmopolitan design, developed especially for urban use and will protect you from the wind and the weather while improving aerodynamic capacity. Made of 3 mm. polycarbonate.

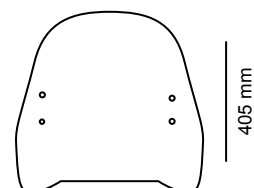

390 mm  
2 FIXATION POINTS

- H Smoke
- W Clear

(\*) Check price with your distributor.



# WINDSHIELD T.S.



\* Check availability for motorcycle models at [www.puig.tv](http://www.puig.tv) typing in the searching window:

**T.S.**



**PMMA**  
ACRYLIC

MODEL	REF.	W
UNIVERSAL	6371	(*)

Manufactured in 3 mm. PMMA (polymethylmetacrylate), material very resistant to possible impacts and with great aerodynamic capacity.

**W** Clear

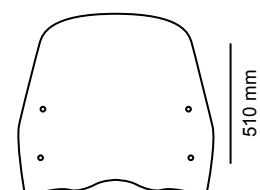

480 mm

2 FIXATION POINTS

(\*) Check price with your distributor.

# WINDSHIELD T.X.



\* Check availability for motorcycle models at [www.puig.tv](http://www.puig.tv) typing in the searching window:

**TX**



MODEL	REF.	W
UNIVERSAL	1952	(*)

Evolution of T.S. Made of 4 mm. PMMA. (Polymethylmetacrylate), material very resistant to possible impacts and with great aerodynamic capacity.

**W** Clear

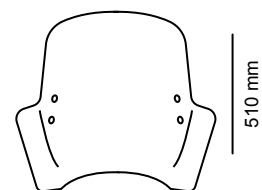

555 mm  
2 FIXATION POINTS

(\*) Check price with your distributor.

# HANDGUARDS



\* Check availability for motorcycle models at [www.puig.tv](http://www.puig.tv) typing in the searching window:

**HANDGUARDS**



MODEL	REF.	W
HANDGUARDS UNIVERSAL	6855	(*)

Manufactured in PMMA (polymethylmetacrylate) 3 mm. So it will be a barrier to possible objects that can impact on the rider's hands and protect them from cold and wind, providing a great aerodynamic capacity to the motorcycle. It is necessary to mount an TX or TS screen to install mittens.

W Clear

(\*) Check price with your distributor.



# DASHBOARD PROTECTOR



\* Check availability for motorcycle models at [www.puig.tv](http://www.puig.tv) typing in the searching window:

**DASHBOARD**



**NEW!**

Durable and waterproof  
self-adhesive vinyl



Adhesive



Easy to apply so there  
are no air bubbles



Easy to clean



Anti-scratch treatment

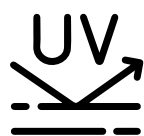

UV resistant



Protect the digital screen of your motorcycle with this practical vinyl. More and more motorcycle models incorporate an LCD screen as an instrument panel, which is why Puig has this protector in its catalog that prevents annoying damage caused by scratches, dirt accumulation and premature wear.

Manufactured specifically for each motorcycle model, the vinyl layer is made of a special material that filters air bubbles, allowing a perfect fit and placement.

# 2

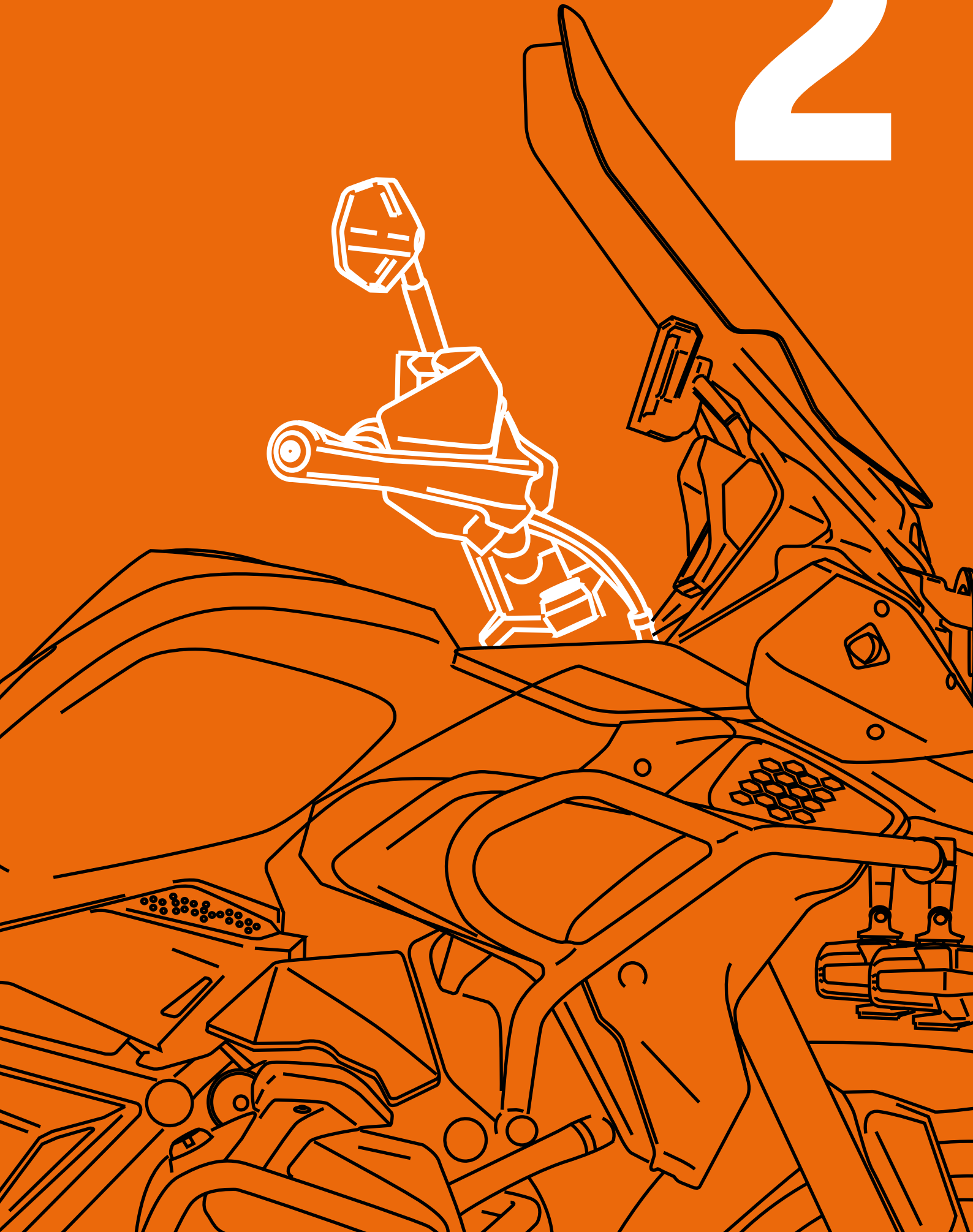



# HANDLEBAR AREA

ASCENT GRIPS	<b>186</b>	REARVIEW MIRROR GRAND TRACKER	<b>216</b>
BAR ENDS BALANCE	<b>204</b>	REARVIEW MIRROR GT.1	<b>234</b>
BAR ENDS LONG AND SHORT	<b>200</b>	REARVIEW MIRROR GTI	<b>236</b>
BAR ENDS SHORT WITH RING AND RACE	<b>206</b>	REARVIEW MIRROR HI-TECH IV	<b>220</b>
BAR ENDS SPEED	<b>198</b>	REARVIEW MIRROR HI-TECH V	<b>210</b>
BAR ENDS SPORT	<b>196</b>	REARVIEW MIRROR HYPERNAKED	<b>230</b>
BAR ENDS THRUSTER	<b>202</b>	REARVIEW MIRROR LOOK	<b>214</b>
BASIC GRIPS	<b>194</b>	REARVIEW MIRROR MONACO	<b>224</b>
BRAKE / CLUTCH LEVER PROTECTOR	<b>172</b>	REARVIEW MIRROR MP	<b>222</b>
BRAKE / CLUTCH LEVER PROTECTOR WITH MIRROR PRO	<b>170</b>	REARVIEW MIRROR RETRO	<b>228</b>
BRAKE-CLUTCH LIQUID TANK COVER	<b>180</b>	REARVIEW MIRROR TOP-TECH I	<b>226</b>
CORE GRIPS	<b>192</b>	REARVIEW MIRROR TRACKER	<b>218</b>
GLOVE FOR FRONT BRAKE TANK	<b>181</b>	REARVIEW MIRROR Z2	<b>242</b>
HANDLEBAR DEFLECTORS	<b>258</b>	REARVIEW MIRROR Z3	<b>240</b>
HANDLEBAR REINFORCEMENT	<b>164</b>	RISERS	<b>160</b>
HANDLEBARS	<b>158</b>	SCOOTER LEVERS	<b>174</b>
HERITAGE LEVERS	<b>176</b>	VINTAGE GRIPS	<b>184</b>
IN-TAKE CHARGE	<b>263</b>		
LEVERS 3.0	<b>166</b>		
MAXISCOOTER HANDGUARDS	<b>256</b>		
MIRROR COVERS WITH TURN SIGNALS	<b>250</b>		
MIRROR VIEW THREAD TRIM PLUG	<b>244</b>		
MOBILE CASE	<b>262</b>		
MOBILE PHONE SUPPORT	<b>260</b>		
MOBILE SUPPORTS	<b>264</b>		
MOTORCYCLE HANDGUARD EXTENSIONS	<b>254</b>		
MOTORCYCLE HANDGUARDS	<b>252</b>		
OFF-ROAD LEVERS	<b>178</b>		
ORIGINAL REARVIEW MIRRORS CAPS, SUPPORT AND SHIFTER	<b>246</b>		
PARKING BRAKE LEVER	<b>182</b>		
PULLBACK RISERS	<b>162</b>		
RACING GRIPS	<b>190</b>		
RADIKAL GRIPS	<b>188</b>		
REARVIEW MIRROR CAPS	<b>248</b>		
REARVIEW MIRROR EXPLORER	<b>232</b>		
REARVIEW MIRROR F1.1	<b>238</b>		
REARVIEW MIRROR FOLD	<b>208</b>		
REARVIEW MIRROR FOLD	<b>212</b>		

# HANDLEBARS



\* Check availability for motorcycle models at [www.puig.tv](http://www.puig.tv) typing in the searching window:

**HANDLEBAR**



Manufactured in aluminum and later anodized in various colors to protect them against possible impacts and guarantee resistance to corrosion.

To choose between two types of handlebars: cylindrical and conical.

**A** Blue  
**N** Black

**O** Gold  
**P** Silver

**R** Red

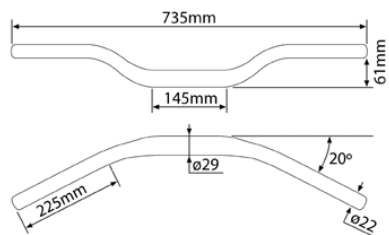

REF. 74920



Ø mm.	H (mm.)	REF.	A N O P R
22/29	20	7492 (#)	(*)
22/29	40	7493 (#)	(*)
22/29	61	6461	(*)

(#) Handlebars with M16/150 internal thread.

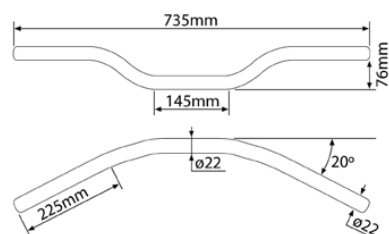

REF. 7494R



Ø mm.	H (mm.)	REF.	A N O P R
22	76	6242 (#)	(*)
22	46	7494 (#)	(*)

(#) Handlebars with M16/150 internal thread.

(\*) Check price with your distributor.

NOTE: Handlebars suitable for our bar ends [see website](#).



# RISERS



\* Check availability for motorcycle models at [www.puig.tv](http://www.puig.tv) typing in the searching window.

**RISER**



● N Black

□ P Aluminium

REF. 20308N  
Ø 32



REF. 20308P  
Ø 32



REF. 20309N  
Ø 32



REF. 20309P  
Ø 32



REF. 20667N  
Ø 25



REF. 20667P  
Ø 25



REF. 3671-3740  
Ø 22/29



REF. 3671-3740  
Ø 22/29



REF. 3672-3741  
Ø 22/29

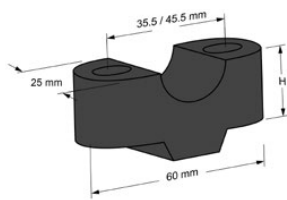

Ø 22/29

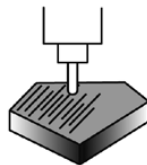

**CNC MACHINED**

Machined from billet aluminium and anodized in different colors.



**FUNCTIONAL**

Permite elevar el manillar.

Perfect piece to raise the position of your motorcycle's handlebars, improving your position while riding.

H (mm.)	Ø mm.	REF.	N P
20	22	3671	(*)
20	29	3740	(*)
20	32	20308	(*)
30 (#)	22	3672	(*)
30 (#)	29	3741	(*)
30 (#)	32	20309	(*)
20	25	20667	(*)

(#) May require wiring extension.

(\*) Check price with your distributor.

# PULLBACK RISERS



\* Check availability for motorcycle models at [www.puig.tv](http://www.puig.tv) typing in the searching window:

**PULLBACK**

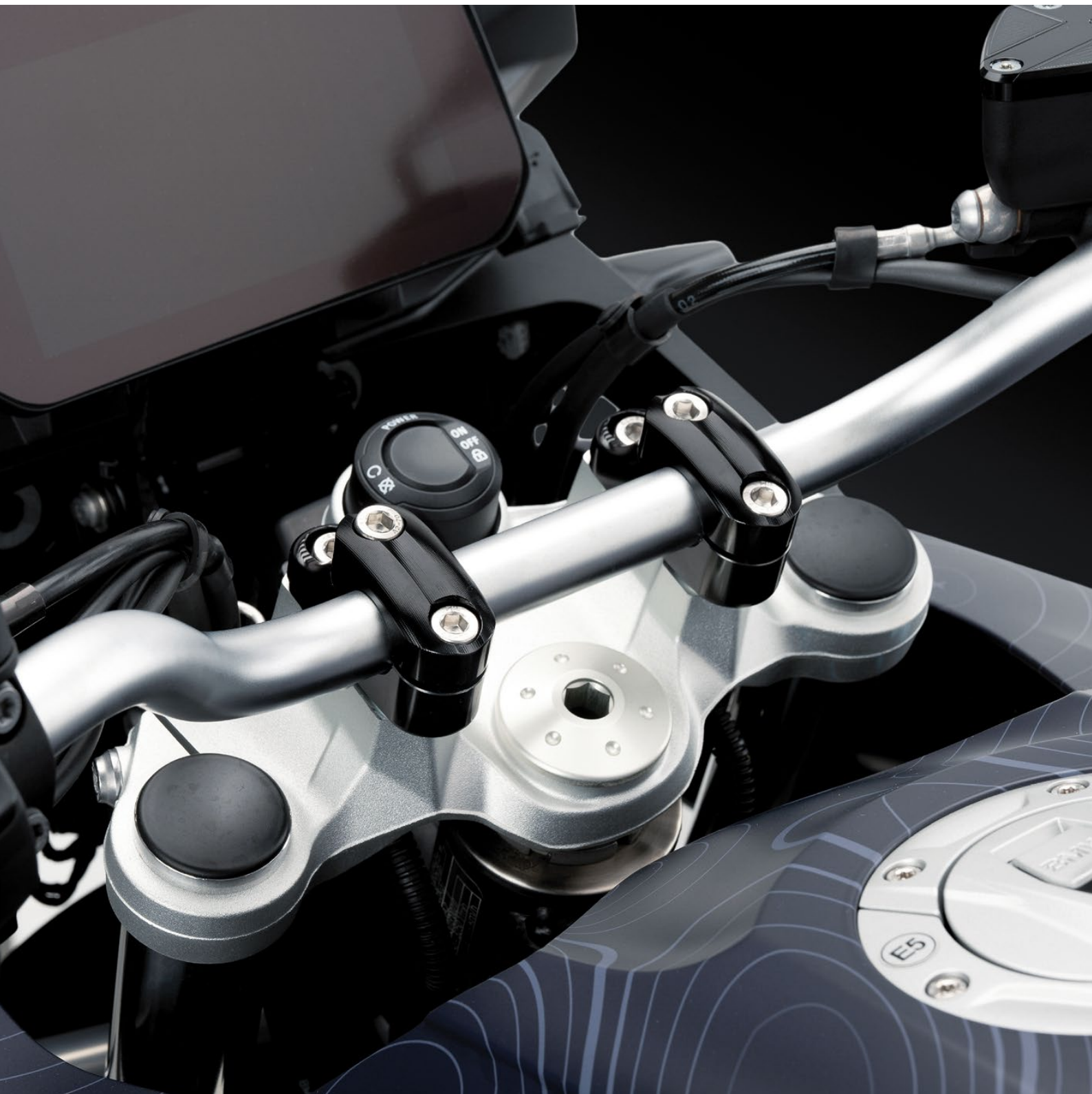

● N Black

□ P Aluminium



**NEW!**



REF. 21750N  
Ø 22



REF. 21751N  
Ø 29

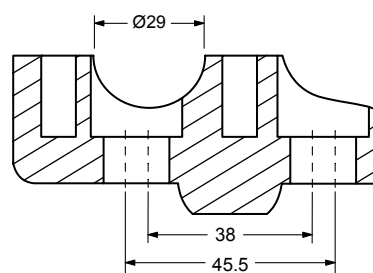
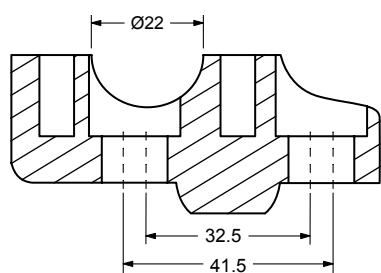

Two universal models for handlebars with diameter of 22 and diameter of 29 + specific models.

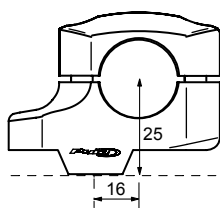

**DIMENSIONS**

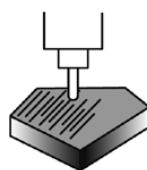

**CNC MACHINED**

Machined from a block of aluminum and later black and silver anodized.

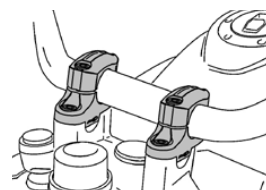

**FUNCTIONAL**

Ergonomic function: raises and brings the handlebar closer to the rider.

H (mm.)	Ø mm.	REF.	N P
20	22	21750	(*)
22	29	21751	(*)

(\*) Check price with your distributor.

# HANDLEBAR REINFORCEMENT



\* Check availability for motorcycle models at [www.puig.tv](http://www.puig.tv) typing in the searching window:

**HANDLEBAR REINFORCEMENT**



**A** Blue  
**N** Black

**P** Aluminium  
**R** Red



REF. 9256A



REF. 9256N



REF. 9256P

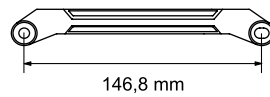

REF. 9256R

**DIMENSIONS**

Milled piece made of aluminum, with a high-quality anodized finish, which adds an attractive personal aesthetic touch to the area of the Tracer's control panel.



# LEVERS 3.0



\* Check availability for motorcycle models at [www.puig.tv](http://www.puig.tv) typing in the searching window.

**MANETAS**



To purchase a complete set of levers, you must purchase a brake lever, a brake lever adaptor, a clutch lever, and a clutch lever adaptor. They do not require modifications on the bike.

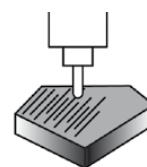

## CNC MACHINED

Machined from billet aluminium and anodized in different colors.

**A** Blue  
**N** Black

**O** Gold  
**P** Silver

**R** Red  
**T** Orange

**V** Green

REF. 210AA

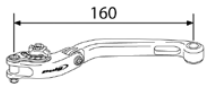

**KG**  
100gr.

REF. 220NA

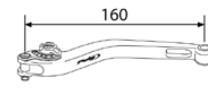

**KG**  
100gr.

FOLDABLE MODEL 3.0	REF.	A N O P R T V
FOLDABLE BRAKE LEVER	SEE PAGE 168	(*)
ADAPTOR BRAKE LEVER	CHECK WEB	
FOLDABLE CLUTCH LEVER	SEE PAGE 168	(*)
ADAPTOR CLUTCH LEVER	CHECK WEB	
SELECTOR (SPARES)	3699	(*)
SCREW - NUT - SPACER - WASHER SPRING (SPARES)(SPARES)	9837	(*)
SPRING	3512	(*)

NON-FOLDABLE MODEL 3.0	REF.	A N O P R T V
NON-FOLDABLE BRAKE LEVER	SEE PAGE 168	(*)
ADAPTOR BRAKE LEVER	CHECK WEB	
NON-FOLDABLE CLUTCH LEVER	SEE PAGE 168	(*)
ADAPTOR CLUTCH LEVER	CHECK WEB	
SELECTOR (SPARES)	3699	(*)
SCREW - NUT - SPACER - WASHER SPRING (SPARES)	9837	(*)
SPRING	3512	(*)

REF. 24ANA

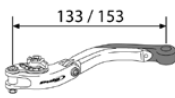

**KG**  
100gr.

REF. 230NA

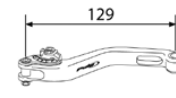

**KG**  
100gr.

EXTENDABLE FOLDING MODEL 3.0	REF.	A N O P R T V
EXTENDABLE FOLDABLE BRAKE LEVER	SEE PAGE 168	(*)
ADAPTOR BRAKE LEVER	CHECK WEB	
EXTENDABLE FOLDABLE CLUTCH HANDLE	SEE PAGE 168	(*)
ADAPTOR CLUTCH LEVER	CHECK WEB	
SELECTOR (SPARES)	3699	(*)
EXTENDABLE KIT	3700	(*)
SCREW - NUT - SPACER - WASHER SPRING (SPARES)	9837	(*)
SET OF SCREW, EXTENDIBLE FASTENING WASHER (SPARES)	20503	(*)
SPRING	3512	(*)

SHORT MODEL 3.0	REF.	A N O P R T V
SHORT BRAKE HANDLE	SEE PAGE 168	(*)
ADAPTOR BRAKE LEVER	CHECK WEB	
SHORT CLUTCH LEVER	SEE PAGE 168	(*)
ADAPTOR CLUTCH LEVER	CHECK WEB	
SELECTOR (SPARES)	3699	(*)
SCREW - NUT - SPACER - WASHER SPRING (SPARES)	9837	(*)
SPRING	3512	(*)

(\*) Check price with your distributor.

# 5 STEPS TO FIND THE PART# FOR YOUR LEVERS 3.0

## 1. SELECT TYPE OF LEVER

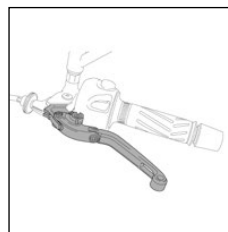
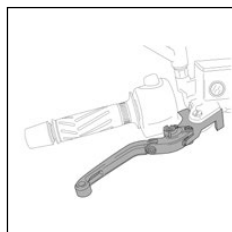

1

2

## 2. SELECT MODEL OF LEVER 3.0

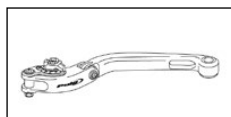

FOLDABLE

1

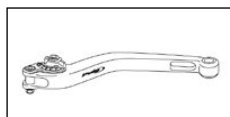

NON-FOLDABLE

2

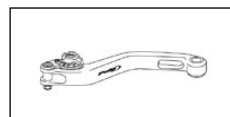

SHORT

3

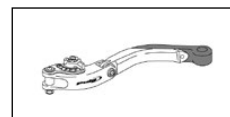

EXTENDABLE FOLDABLE

4

## 3. SELECT COLOR OF EXTENDABLE

ALWAYS ZERO

0

SELECT COLOR OF EXTENDABLE

## 4. SELECT COLOR OF LEVER

COLOR OF LEVER

ALWAYS IN BLACK

## 5. SELECT COLOR OF SELECTOR

COLOR OF SELECTOR

A Blue  
 N Black

O Gold  
 P Silver

R Red  
 T Orange

V Green



# EXAMPLES ON HOW TO OBTAIN THE PART# FOR THE 3.0 LEVERS



REF. 240NO

**2** CLUTCH  
**4** EXTENDABLE FOLDABLE  
**0** COLOR OF EXTENDABLE  
**N** ALWAYS IN BLACK  
**0** COLOR OF SELECTOR



REF. 120AN

**1** BRAKE  
**2** NON-FOLDABLE  
**0** ALWAYS ZERO  
**A** COLOR OF LEVER  
**N** COLOR OF SELECTOR



REF. 210NT

**2** CLUTCH  
**1** FOLDABLE  
**0** ALWAYS ZERO  
**N** COLOR OF LEVER  
**T** COLOR OF SELECTOR



REF. 130NA

**1** BRAKE  
**3** SHORT  
**0** ALWAYS ZERO  
**N** COLOR OF LEVER  
**A** COLOR OF SELECTOR



## THERMAL GLOVES ANTI-VIBRATION

See page 478.

# BRAKE / CLUTCH LEVER PROTECTOR WITH MIRROR PRO



\* Check availability for motorcycle models at [www.puig.tv](http://www.puig.tv) typing in the searching window:

**LEVER PROTECTOR**



The ideal complement for the lever handle protector, with an elegant and minimalist style. Machined from a block of aluminum and anodized finish. Once the ideal position has been established to protect the handle, the mirror can be adjusted manually without the need for any tool.

Only the end of the lever protection can be obtained in different colors. All other components remain black anodized.

**A** Blue  
**N** Black

**O** Gold  
**P** Silver

**R** Red  
**T** Orange

**V** Green

**NOT HOMOLOGATED**

**KG**  
215gr.



REF. 21441N

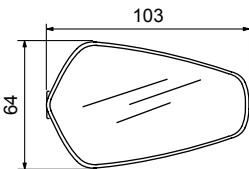
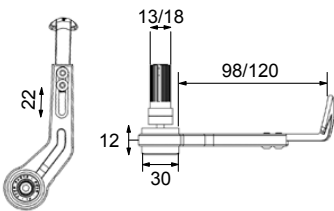

**DIMENSIONS**

103 x 64 mm.

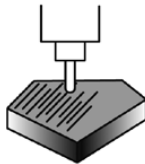

**CNC MACHINED**

Machined from billet aluminium and anodized in black.

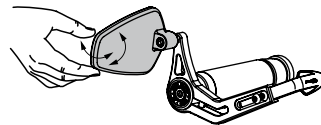

**ADJUSTABLE**

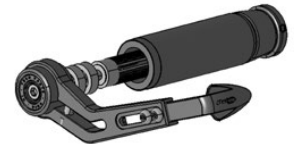

**ADAPTABLE**

Specific available adapters for bike model.

MODEL	REF.	ANOPRTV
BRAKE LEVER PROTECTOR WITH REARVIEW MIRROR PRO	21440	(*)
CLUTCH LEVER PROTECTOR WITH REARVIEW MIRROR PRO	21441	(*)

SPARES	REF.	ANOPRTV
TIP PROTECTOR FOR BRAKE LEVER - SPARE	3766	(*)
END TIP PROTECTOR CLUTCH LEVER - SPARE	3878	(*)

(\*) Check price with your distributor.

**NOTE:** Universal models for handlebars diameters between 13-18 mm.

For models that require adapters **check web.**

References for bar ends on the clutch side to match the bar end used with the brake lever protector **check web.**



# BRAKE / CLUTCH LEVER PROTECTOR



\* Check availability for motorcycle models at [www.puig.tv](http://www.puig.tv) typing in the searching window:

**LEVER PROTECTOR**



The brake lever protector arises from the need to avoid accidental contact with other riders, avoiding the activation of the brakes and the consequent fall. In the design, Puig has prioritized protection and the integration of the protector into the set. For this, a bidirectional adjustment system of the protector, longitudinal and perpendicular to the fist, has been made.

**A** Blue  
**N** Black

**O** Gold  
**P** Silver

**R** Red  
**T** Orange

**V** Green

**KG**  
130gr.



REF. 3765R

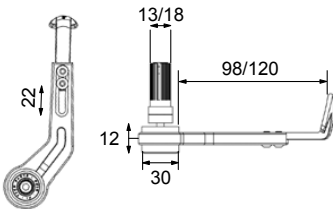

DIMENSIONS

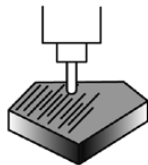

CNC MACHINED

Machined from billet aluminium and anodized in different colors.

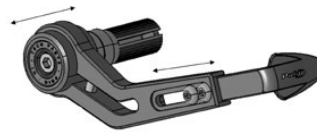

ADJUSTABLE

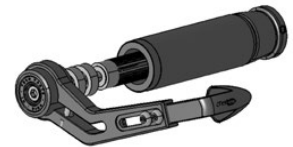

ADAPTABLE

Specific available adapters for bike model.

**MODEL**

BRAKE LEVER PROTECTOR UNIVERSAL 13-18 mm. DIAMETER  
CLUTCH LEVER PROTECTOR UNIVERSAL 13-18 mm. DIAMETER

**REF.**

3765  
3877

**ANOPRTV**

(\*)  
(\*)

**SPARES**

TIP PROTECTOR FOR BRAKE LEVER - SPARE  
END TIP PROTECTOR CLUTCH LEVER - SPARE

**REF.**

3766  
3878

**ANOPRTV**

(\*)  
(\*)

(\*) Check price with your distributor.

**NOTE:** Universal models for handlebars diameters between 13-18 mm.

For models that require adapters **check web.**

References for bar ends on the clutch side to match the bar end used with the brake lever protector **check web.**

# SCOOTER LEVERS



\* Check availability for motorcycle models at [www.puig.tv](http://www.puig.tv) typing in the searching window:

**SCOOTER LEVERS**



**A** Blue  
**N** Black

**O** Gold  
**P** Silver

**R** Red  
**T** Orange

**V** Green



**KG**  
120gr.

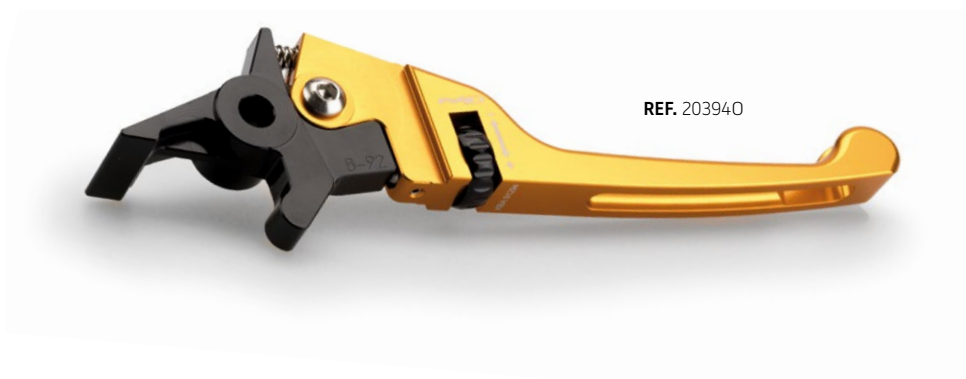

REF. 203940



REF. 20751R

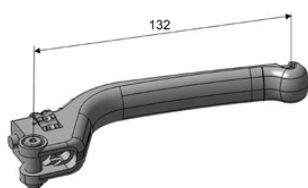

**DIMENSIONS**

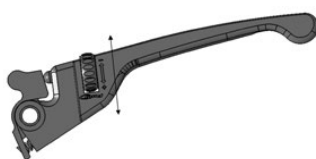

**ADJUSTABLE**

In distance to fist.

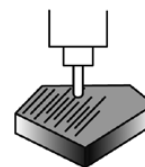

**CNC MACHINED**

Machined from billet aluminium and anodized in different colors.

Lever milled from an aluminum block, it has been anodized in different colors to combine the exclusivity of the machined finish with the most avant-garde ergonomics. Its design fits with the scooters on the market, with a more sporty and premium aesthetic.



**NOTE:** Adaptors included when requesting the lever reference.

# HERITAGE LEVERS



\* Check availability for motorcycle models at [www.puig.tv](http://www.puig.tv) typing in the searching window:

**HERITAGE**



**TÜV**

**ABE**  
91294

**TYP**  
LEV

Designed specifically for the best-selling Custom and Heritage models on the market and machined from a block of aluminum, with subsequent color anodizing, it is the perfect option to complement your bike for its attractive design and functionality.

 **N Black**



REF. 9995N



REF. 9996N

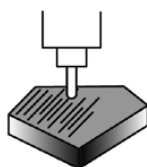

**CNC MACHINED**

Machined from billet aluminium and anodized in black.

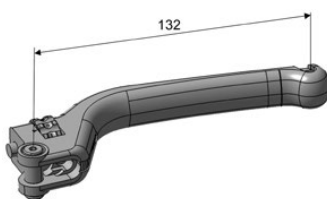

**DIMENSIONS**



**ADJUSTABLE**

In distance to fist.

**NON-FOLDABLE MODEL**

	REF.	N
NON-FOLDABLE BRAKE LEVER	9995N	(*)
NON-FOLDABLE BRAKE LEVER	9996N	(*)

(\*) Check price with your distributor.



# OFF-ROAD LEVERS



\* Check availability for motorcycle models at [www.puig.tv](http://www.puig.tv) typing in the searching window:

**OFF-ROAD**



If riding on asphalt bores you and off-road routes are your escape route, complement your motorcycle with the new Off-Road levers from Puig. They are served together with the necessary hardware for assembly.

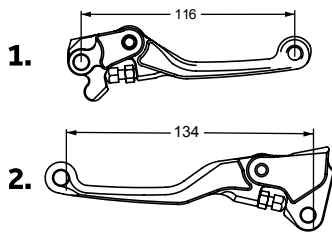

**DESIGN**

Exclusive design:  
Clutch lever - length of lever for 4 fingers.  
Brake lever - length for 3 fingers.

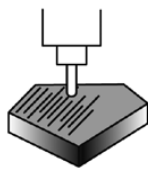

**CNC MACHINED**

Machined from billet aluminium and anodized in different colors.

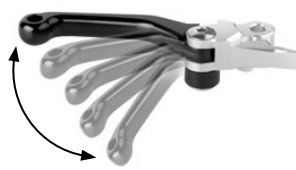

**FOLDS OUTWARD**

Adaptor designed with spring which allows the lever to swing forward to avoid the lever to twist or break.

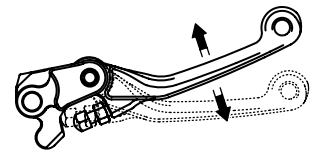

**REGULATION**

The adjustable system allows to adjust the position for rider's needs.

**SPARES**

	REF.	N
BRAKE LEVER	88888N	(*)
CLUTCH LEVER	99999N	(*)

(\*) Check price with your distributor.

# BRAKE-CLUTCH LIQUID TANK COVER



\* Check availability for motorcycle models at [www.puig.tv](http://www.puig.tv) typing in the searching window:

**FLUID TANK CAP**

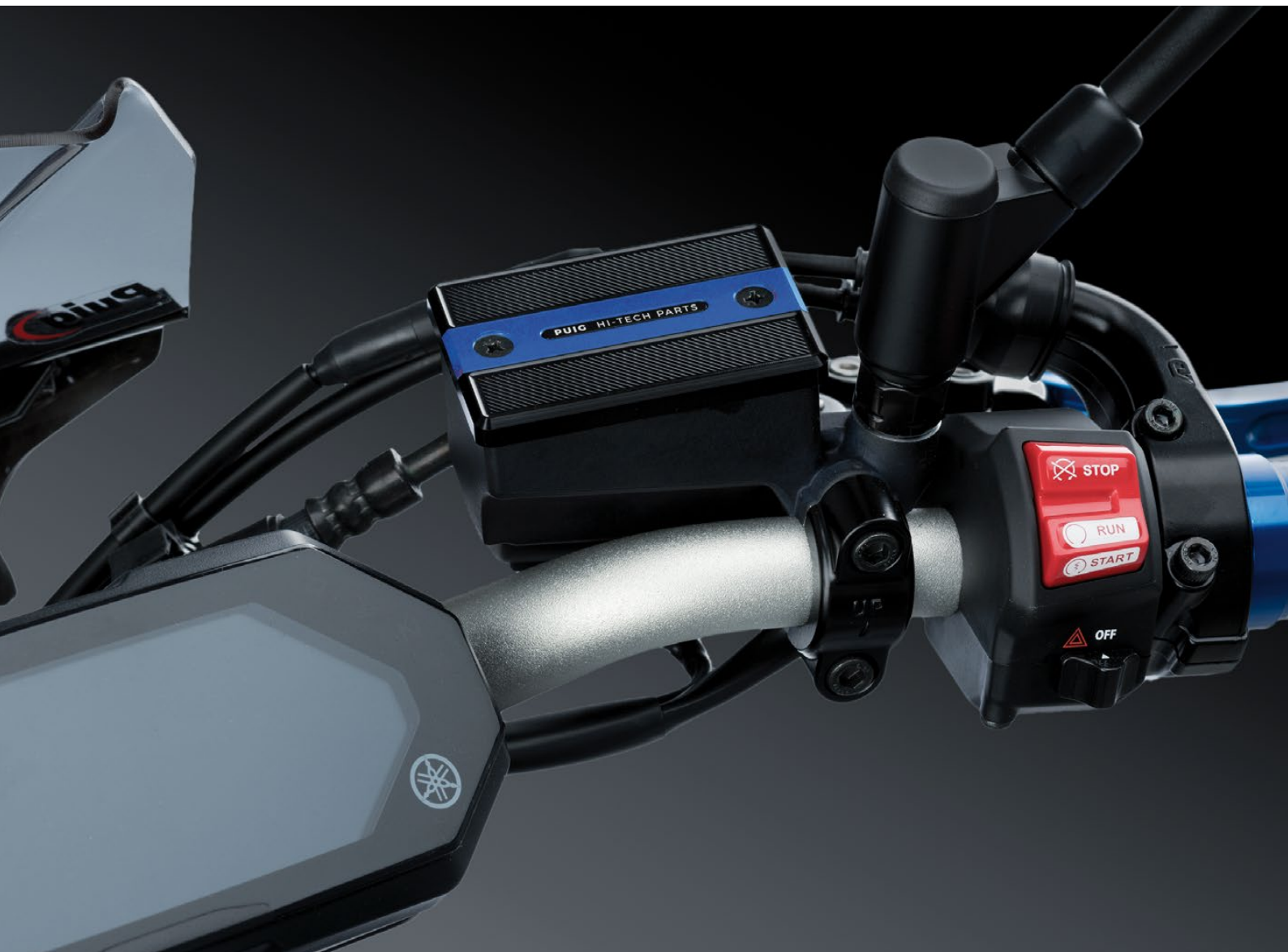

## LOOKS

Improves the looks of the bike adding a touch of exclusivity.

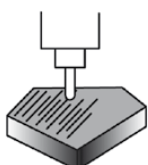

## CNC MACHINED

Machined from billet aluminium and anodized in different colors.

**A** Blue  
**N** Black

**O** Gold  
**P** Silver

**R** Red  
**T** Orange

**V** Green

REF. 9612V





# GLOVE FOR FRONT BRAKE TANK



\* Check availability for motorcycle models at [www.puig.tv](http://www.puig.tv) typing in the searching window:

**FRONT BRAKE TANK GLOVE**



REF. 5208N

MODEL	REF.	N
GLOVE FOR FRONT BRAKE TANK	5208N	(*)

On some motorcycles, the position of this element is especially exposed to the impact of gravel or other objects when riding, and this cover responds to the need of the biker to protect those sensitive elements of his vehicle.



■ N Black

(\*) Check price with your distributor.

# PARKING BRAKE LEVER



\* Check availability for motorcycle models at [www.puig.tv](http://www.puig.tv) typing in the searching window:

**PARKING BRAKE LEVER**



Product specifically designed for two of the most popular maxi scooters: Kymco AK550 and Yamaha T-Max. It replaces the original and gives the bike a more elegant and sport customized detail.

**A** Blue  
**N** Black

**O** Gold  
**P** Silver

**R** Red



REF. 85000



REF. 8500A



REF. 8500N



REF. 8500P

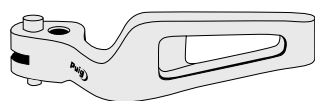

REF. 8500R

**LOOK**

Improves the looks of the bike adding a touch of exclusivity.

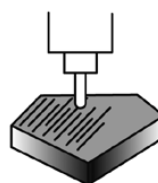
**CNC MACHINED**

Machined from billet aluminium and anodized in different colors.





# VINTAGE GRIPS

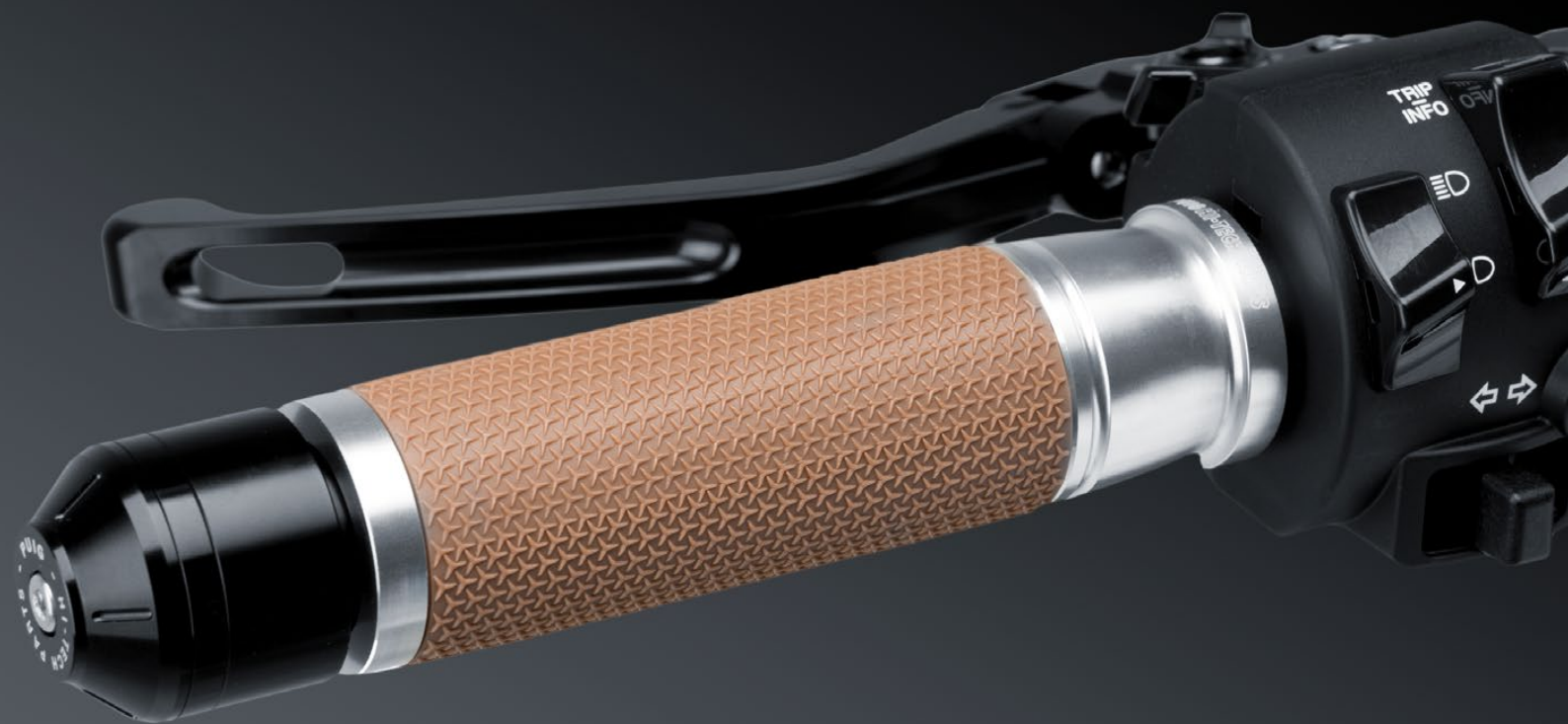

\* Check availability for motorcycle models at [www.puig.tv](http://www.puig.tv) typing in the searching window:

**VINTAGE**



-  N Black
-  P Silver

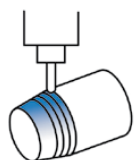

REF. 9190N

**MATERIAL**

Manufactured from  
billet aluminium.

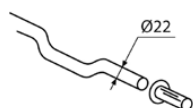
**HANDLEBAR**

Suitable for diameter  
22 mm.

**RUBBER**

Non-skid texture.  
Pleasant compound.

**THROTTLE ADAPTORS**

Included.

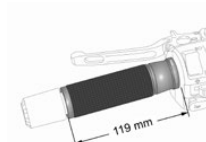
**DIMENSIONS**

Long 119 mm.

**MODEL**

VINTAGE GRIPS BY PAIR

**DIMENSIONS**

119 mm.

**REF.**

9190

**N P**

(\*)

\* Not suitable with the electronic system ride by wire.

\* Not suitable with oem heated grips.

\* Not suitable for bikes where the grips cannot be separated from the gas cane.

# ASCENT GRIPS



\* Check availability for motorcycle models at [www.puig.tv](http://www.puig.tv) typing in the searching window.

**ASCENT**

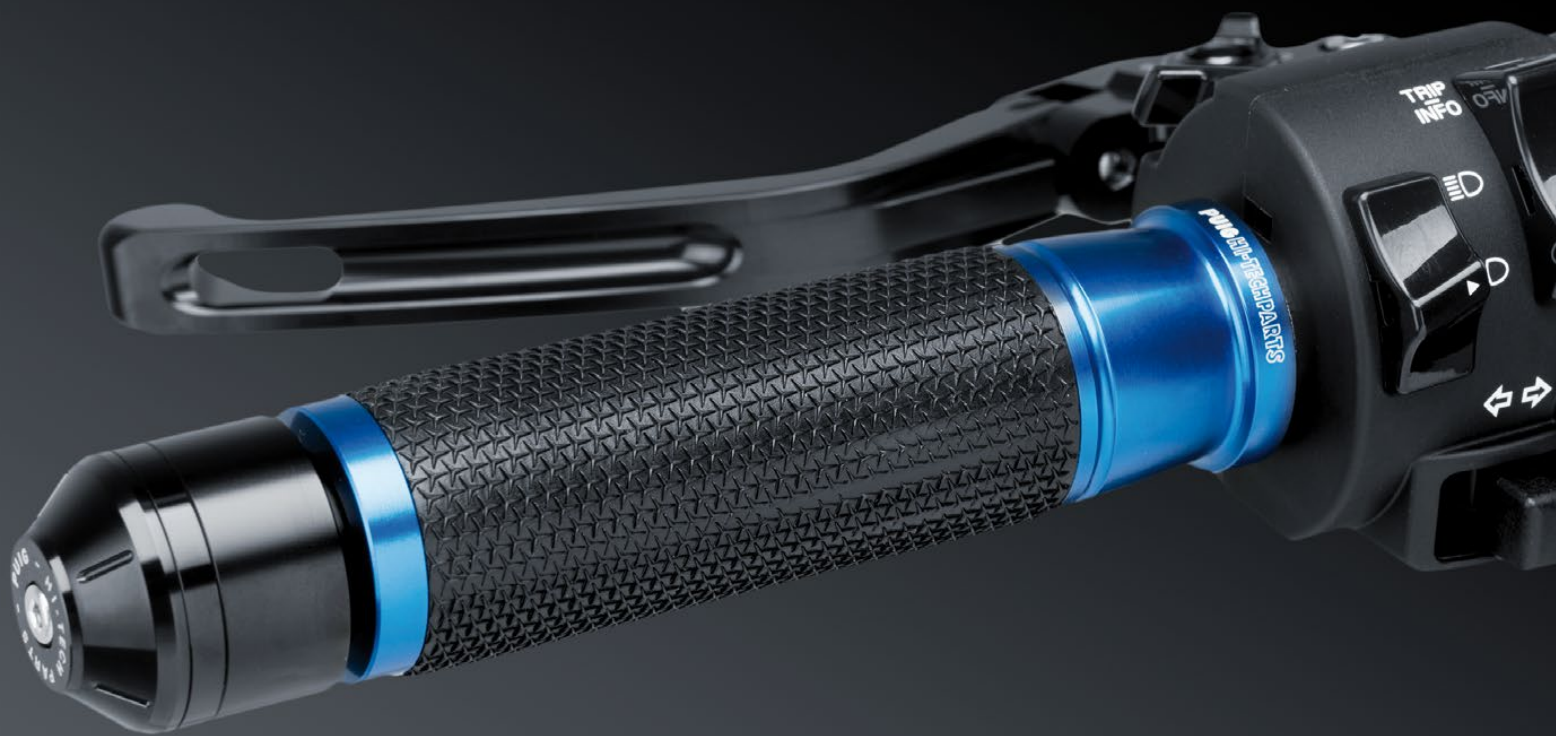

**A** Blue  
**N** Black

**O** Gold  
**P** Silver

**R** Red  
**T** Orange

**V** Green



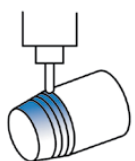

REF. 6326A

**MATERIAL**

Manufactured from  
billet aluminium.

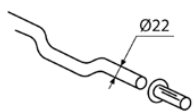
**HANDLEBAR**

Suitable for diameter  
22 mm.

**RUBBER**

Non-skid texture.  
Pleasant compound.

**THROTTLE ADAPTORS**

Included.

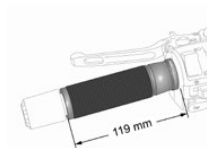
**DIMENSIONS**

Long 119 mm.

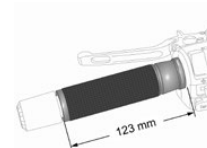
**DIMENSIONS**

Long 123 mm.

MODEL	DIMENSIONS	REF.	A N O P R T V
ASCENT GRIPS BY PAIR	119 mm.	6326	(*)
ASCENT GRIPS BY PAIR	123 mm.	3553	(*)

(\*) Check price with your distributor.

\* Not suitable with the electronic system ride by wire.

\* Not suitable with oem heated grips.

\* Not suitable for bikes where the grips cannot be separated from the gas cane.

# RADIKAL GRIPS



\* Check availability for motorcycle models at [www.puig.tv](http://www.puig.tv) typing in the searching window:

**RADIKAL**



**A** Blue  
**C** Carbon look

**N** Black  
**O** Gold

**P** Silver  
**R** Red

**T** Orange  
**V** Green

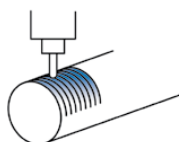

REF. 63250

**DETAIL**

Aluminium anodized insertion in different colors.

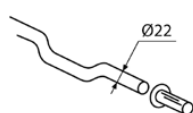
**HANDLEBAR**

Suitable for diameter 22 mm.

**RUBBER**

Non-skid texture. Pleasant compound.

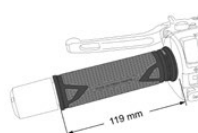
**DIMENSIONS**

Long 119 mm.

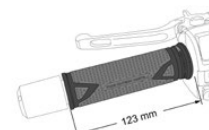
**DIMENSIONS**

Long 123 mm.

MODEL	DIMENSIONS	REF.	ACNOPTV
RADIKAL GRIPS BY PAIR	119 mm.	6325	(*)
RADIKAL GRIPS BY PAIR	123 mm.	8191	(*)

(\*) Check price with your distributor.

\* Not suitable with the electronic system ride by wire.

\* Not suitable with oem heated grips.

\* Not suitable for bikes where the grips cannot be separated from the gas cane.

\* **IMPORTANT:** Due to the wide variety of original grips, some motorcycles may need to lower the edges of the gas throttle and the use of glue (such as Fischer MS Express for a correct fixation).

In motorcycle models where it is not possible to separate the rubber grip from the gas cane because they are one piece, it is not possible to install the grips.



# RACING GRIPS



\* Check availability for motorcycle models at [www.puig.tv](http://www.puig.tv) typing in the searching window:

**RACING GRIPS**

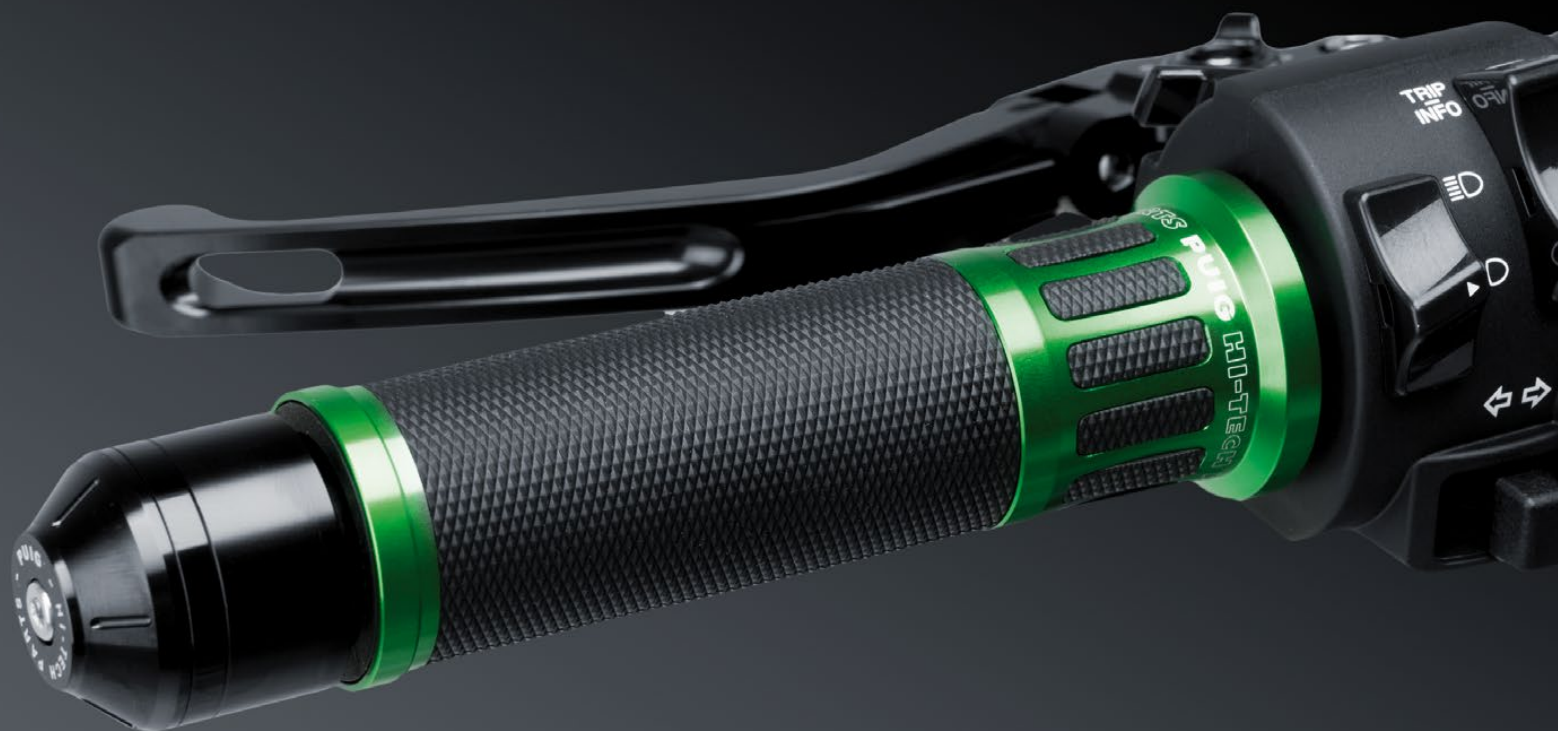

**A** Blue  
**N** Black

**O** Gold  
**P** Silver

**R** Red  
**T** Orange

**V** Green

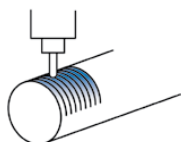

REF. 5879A

**DETAIL**

Aluminium anodized insertion in different colors.

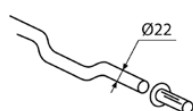
**HANDLEBAR**

Suitable for diameter 22 mm.

**RUBBER**

Non-skid texture. Pleasant compound.

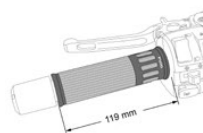
**DIMENSIONS**

Long 119 mm.

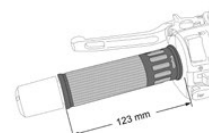
**DIMENSIONS**

Long 123 mm.

MODEL	DIMENSIONS	REF.	ANOPRTV
RACING GRIPS BY PAIR	119 mm.	5879	(*)
RACING GRIPS BY PAIR	123 mm.	8188	(*)

(\*) Check price with your distributor.

\* Not suitable with the electronic system ride by wire.

\* Not suitable with oem heated grips.

\* Not suitable for bikes where the grips cannot be separated from the gas cane.

\* **IMPORTANT:** Due to the wide variety of original grips, some motorcycles may need to lower the edges of the gas throttle and the use of glue (such as Fischer MS Express) for a correct fixation.

In motorcycle models where it is not possible to separate the rubber grip from the gas cane because they are one piece, it is not possible to install the grips.

# CORE GRIPS



\* Check availability for motorcycle models at [www.puig.tv](http://www.puig.tv) typing in the searching window.

**CORE**



**A** Blue  
**G** Yellow

**N** Black  
**R** Red

**T** Orange  
**V** Green

**U** Grey



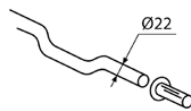

REF. 20796V

**HANDLEBAR**

Suitable for diameter  
22 mm.

**RUBBER**

Non-skid texture.  
Pleasant compound.

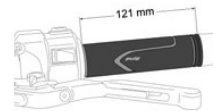
**DIMENSIONS**

Long 121 mm.

MODEL	DIMENSIONS	REF.	AGNRTVU
CORE GRIPS BY PAIR	121 mm.	20796	(*)

(\*) Check price with your distributor.

\* Not suitable with the electronic system ride by wire.

\* Not suitable with oem heated grips.

\* Not suitable for bikes where the grips cannot be separated from the gas cane.

\* **IMPORTANT:** Due to the wide variety of original grips, some motorcycles may need to lower the edges of the gas throttle and the use of glue (such as Fischer MS Express) for a correct fixation.

In motorcycle models where it is not possible to separate the rubber grip from the gas cane because they are one piece, it is not possible to install the grips.

# BASIC GRIPS



\* Check availability for motorcycle models at [www.puig.tv](http://www.puig.tv) typing in the searching window.

**BASIC**

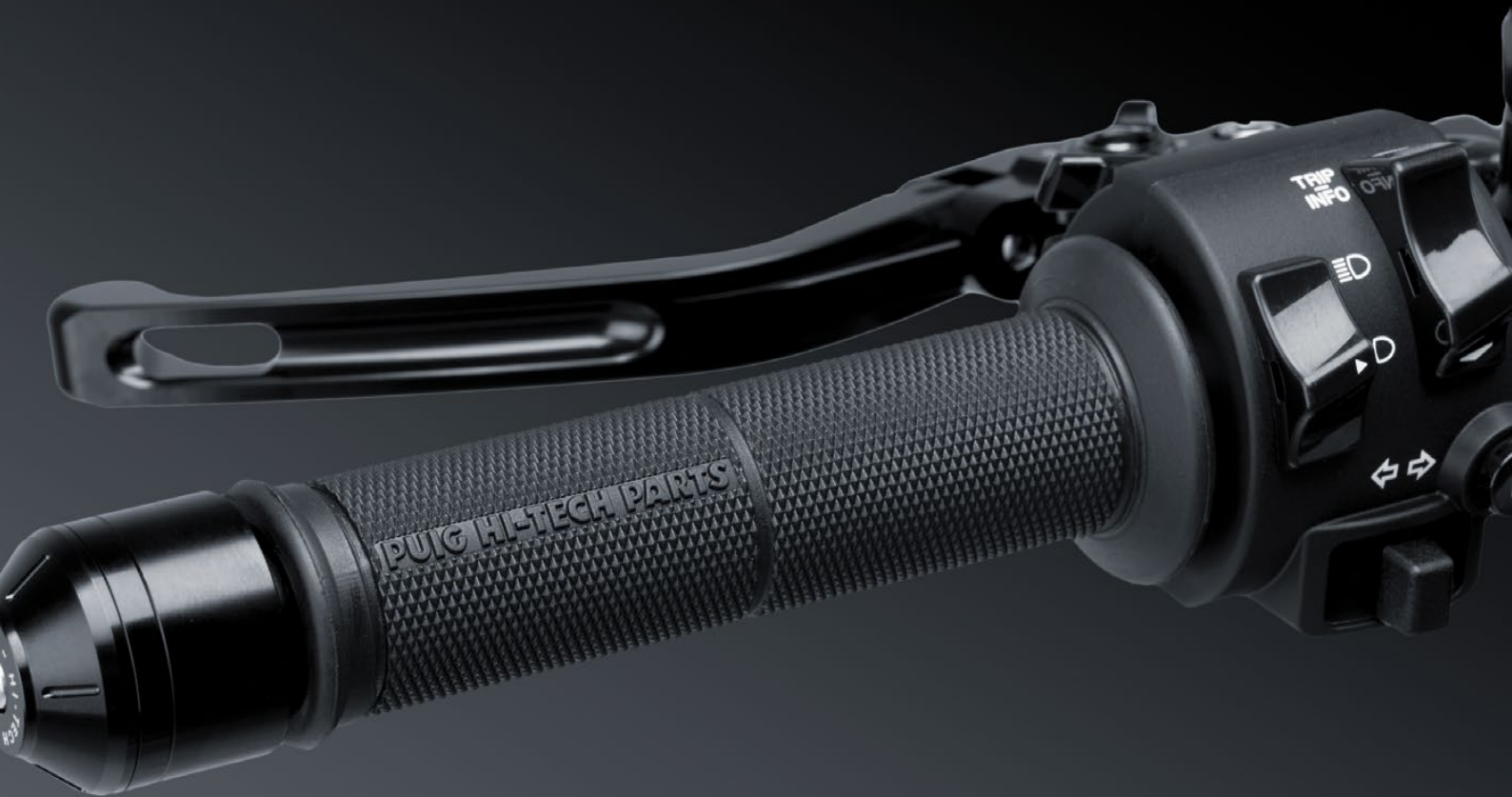

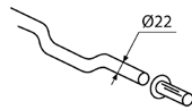

REF. 6405N

**HANDLEBAR**

Suitable for diameter  
22 mm.

**RUBBER**

Non-skid texture.  
Pleasant compound.

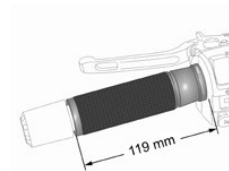
**DIMENSIONS**

Long 119 mm.

MODEL	TOUCH	REF.	N
GRIPS OPENED END BY PAIR	SOFT	6404N	(*)
GRIPS OPENED END BY PAIR	MEDIUM	6405N	(*)
GRIPS OPENED END BY PAIR	HARD	6406N	(*)

(\*) Check price with your distributor.

\* Not suitable with the electronic system ride by wire.

\* Not suitable with oem heated grips.

\* Not suitable for bikes where the grips cannot be separated from the gas cane.

\* **IMPORTANT:** Due to the wide variety of original grips, some motorcycles may need to lower the edges of the gas throttle and the use of glue (such as Fischer MS Express) for a correct fixation.

In motorcycle models where it is not possible to separate the rubber grip from the gas cane because they are one piece, it is not possible to install the grips.



# BAR ENDS SPORT



\* Check availability for motorcycle models at [www.puig.tv](http://www.puig.tv) typing in the searching window:

**BAR ENDS**



**A** Blue  
**N** Black

**O** Gold  
**P** Silver

**R** Red  
**T** Orange

**V** Green

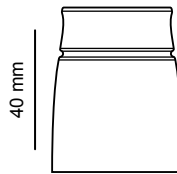

DIMENSIONS

MODEL	REF.	A N O P R T V
BAR ENDS BY PAIR SPORT MODEL		<b>CHECK WEB</b>
SET OF UNIVERSAL BLACK SECTION FOR HANDLEBARS DIAMETERS BETWEEN 13-18 mm.	21011	(*)
BAR ENDS BY PAIR FOR PUIG HANDLEBAR WITH INTERIOR THREAD	20856	(*)

SPARES	REF.	N
WELLNUT M10 BY PAIR	6815N	(*)
WELLNUT M15 BY PAIR	6816N	(*)
WELLNUT M17 BY PAIR	6817N	(*)

(\*) Check price with your distributor.

# BAR ENDS SPEED



\* Check availability for motorcycle models at [www.puig.tv](http://www.puig.tv) typing in the searching window.

**BAR ENDS**



**A** Blue  
**N** Black

**O** Gold  
**P** Silver

**R** Red  
**T** Orange

**V** Green





REF. 21016V

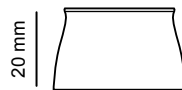

DIMENSIONS

MODEL	REF.	A N O P R T V
BAR ENDS BY PAIR SPEED MODEL		<b>CHECK WEB</b>
SET OF UNIVERSAL SECTION FOR HANDLEBARS DIAMETERS BETWEEN 13-18 mm.	21016	(*)
BAR ENDS BY PAIR FOR PUIG HANDLEBAR WITH INTERIOR THREAD	20858	(*)

SPARES	REF.	N
WELLNUT M10 BY PAIR	6815N	(*)

(\*) Check price with your distributor.

# BAR ENDS LONG AND SHORT



\* Check availability for motorcycle models at [www.puig.tv](http://www.puig.tv) typing in the searching window:

**BAR ENDS**

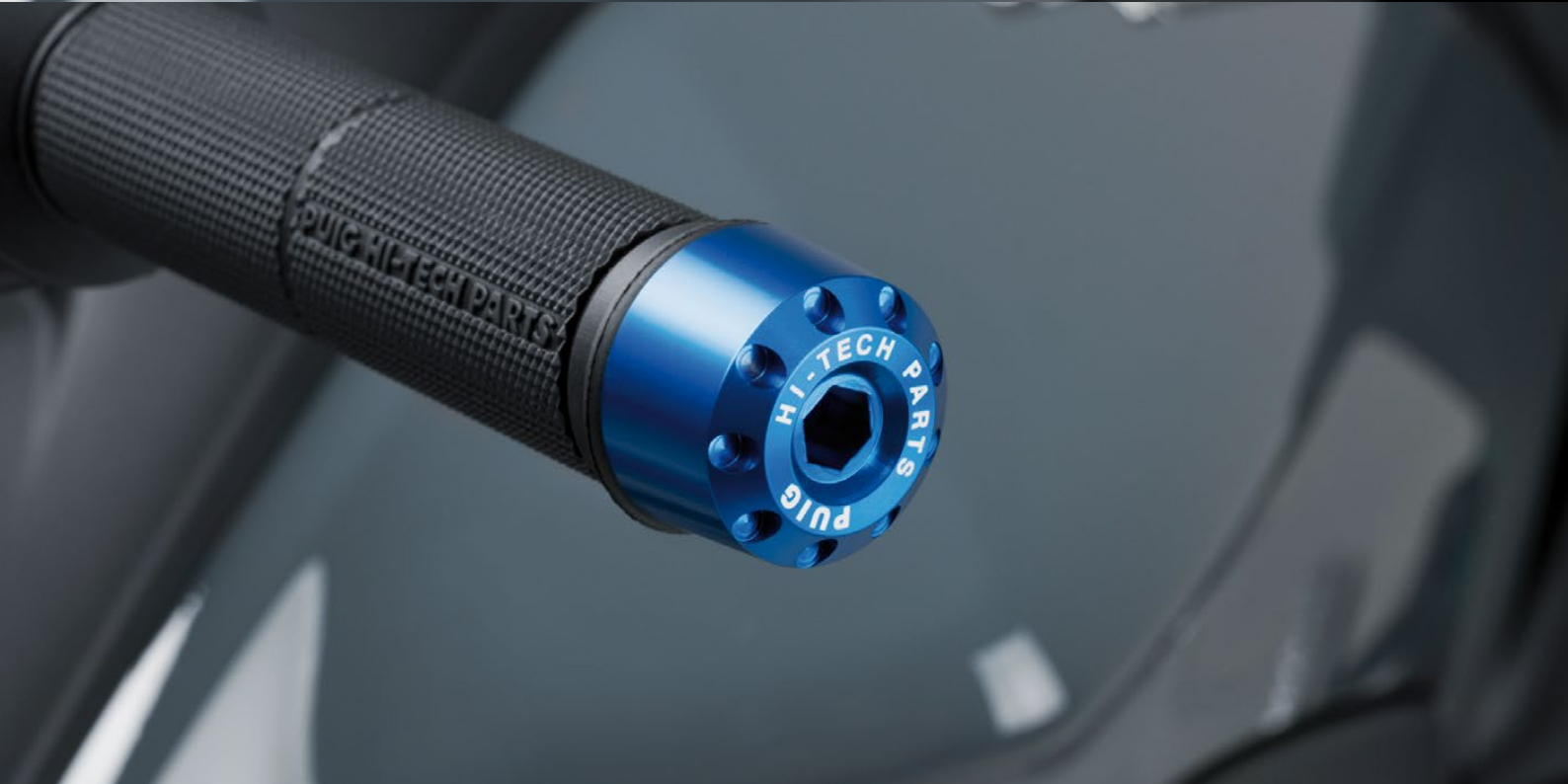

**A** Blue  
**N** Black

**O** Gold  
**P** Silver

**R** Red  
**T** Orange

**V** Green



68gr.



REF. 5777N

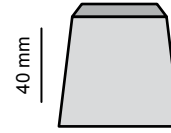

DIMENSIONS

LONG MODEL	REF.	A O R T V
BAR ENDS BY PAIR LONG MODEL	CHECK WEB	
SET OF UNIVERSAL SECTION FOR HANDLEBARS DIAMETERS BETWEEN 13-18 mm.	5777	(*)



36gr.



REF. 6203N

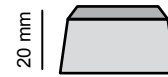

DIMENSIONS

SHORT MODEL	REF.	R V	O
BAR ENDS BY PAIR SHORT MODEL	CHECK WEB		
SET OF UNIVERSAL SECTION FOR HANDLEBARS DIAMETERS BETWEEN 13-18 mm.	6203	(*)	
BAR ENDS BY PAIR FOR PUIG HANDLEBAR WITH INTERIOR THREAD	7424		(*)

**SPARES**

	REF.	N
WELLNUT M10 BY PAIR	6815N	(*)
WELLNUT M15 BY PAIR	6816N	(*)
WELLNUT M17 BY PAIR	6817N	(*)

(\*) Check price with your distributor.





# BAR ENDS THRUSTER



\* Check availability for motorcycle models at [www.puig.tv](http://www.puig.tv) typing in the searching window:

**BAR ENDS**



 **A** Blue  
 **N** Black

 **O** Gold  
 **P** Silver

 **R** Red  
 **T** Orange

 **V** Green



REF. 9411N + 9420V

The black sections and the end caps are sold separately.



REF. 9420

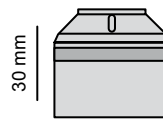

DIMENSIONS

MODEL	REF.	A N O P R T V	N
BLACK SECTION BY PAIR THRUSTER MODEL		<b>CHECK WEB</b>	
SET OF UNIVERSAL SECTION FOR HANDLEBARS DIAMETERS BETWEEN 13-18 mm.	9411		(*)
CAP'S BAR ENDS THRUSTER	9420	(*)	(*)
BAR ENDS BY PAIR FOR PUIG HANDLEBAR WITH INTERIOR THREAD	9594		(*)

SPARES	REF.	N
WELLNUT M10 BY PAIR	6815N	(*)
WELLNUT M15 BY PAIR	6816N	(*)
WELLNUT M17 BY PAIR	6817N	(*)

(\*) Check price with your distributor.

# BAR ENDS BALANCE



\* Check availability for motorcycle models at [www.puig.tv](http://www.puig.tv) typing in the searching window:

**BAR ENDS**



**A** Blue  
**N** Black

**O** Gold  
**P** Silver

**R** Red  
**T** Orange

**V** Green





REF. 21454N + 214560



The set includes 12 rings (2 each color): blue, orange, black, gold, silver and red.

Green rings only for Kawasaki and Universal models.

**DIMENSIONS**

**MODEL**

BAR ENDS BY PAIR BALANCE MODEL

**REF.**

**N**

**CHECK WEB**

SET OF UNIVERSAL SECTION FOR HANDLEBARS DIAMETERS BETWEEN 13-18 mm.

21454

(\*)

BAR ENDS BY PAIR FOR PUIG HANDLEBAR WITH INTERIOR THREAD

21455

(\*)

**SPARES**

RINGS BY PAIR

**REF.**

**A N O P R T V**

21456

(\*)

(\*) Check price with your distributor.

# BAR ENDS SHORT WITH RING AND RACE



\* Check availability for motorcycle models at [www.puig.tv](http://www.puig.tv) typing in the searching window:

**BAR ENDS**



**A** Blue  
**N** Black

**O** Gold  
**P** Silver

**R** Red  
**T** Orange

**V** Green



REF. 8498N



REF. 62220



The set includes 12 rings (2 each color): blue, orange, black, gold, silver and red.

Green rings only for Kawasaki and Universal models.

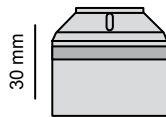

DIMENSIONS

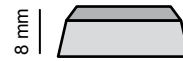

DIMENSIONS

MODEL CORTO CON ARO	REF.	N
BAR ENDS BY PAIR SHORT WITH RING MODELS	CHECK WEB	

RACE MODEL	REF.	ANOPRTV
SET OF UNIVERSAL SECTION FOR HANDLEBARS DIAMETERS BETWEEN 13-18 mm.	6222	(*)

SPARES	REF.	ANOPRTV
RINGS BY PAIR	9170	(*)

SPARES	REF.	N
WELLNUT M10 BY PAIR	6815N	(*)
WELLNUT M15 BY PAIR	6816N	(*)
WELLNUT M17 BY PAIR	6817N	(*)

(\*) Check price with your distributor.



# REARVIEW MIRROR BOND



\* Check availability for motorcycle models at [www.puig.tv](http://www.puig.tv) typing in the searching window:

**BOND**

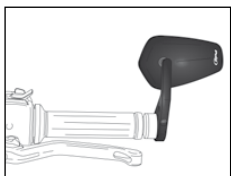

Anti-reflective mirror.

**ANTI-GLARE**



Convex mirror, magnifying glass effect to increase vision.

**D** Aluminium Anodized

**N** Black

**NOT HOMOLOGATED**

**NEW!**



REF. 21633N

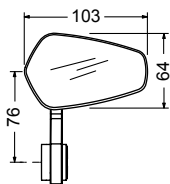

**DIMENSIONS**

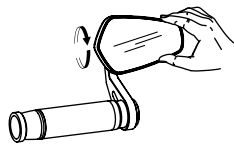

**ADJUSTABLE**

Allows regulation by hand.

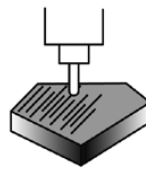

**MATERIAL**

Manufactured from billet aluminium and anodized.



**ADAPTABLE**

Specific available adapters for bike model.

MODEL	SIDE	REF.	D N
UNIVERSAL	RIGHT	21633	(*)
UNIVERSAL	LEFT	21633	(*)

(\*) Check price with your distributor.

**NOTE:** For handlebars with inner diameter of 13/18 mm. To see part# for the adaptors on the models available: **check website.**

# REARVIEW MIRROR HI-TECH V



\* Check availability for motorcycle models at [www.puig.tv](http://www.puig.tv) typing in the searching window:

**HI-TECH V**



Anti-reflective mirror.

**ANTI-GLARE**



Convex mirror, magnifying glass effect to increase vision.

**D** Aluminium Anodized

**N** Black

**HOMOLOGATED**

**NEW!**



REF. 21618N

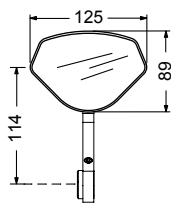

**DIMENSIONS**



**ADJUSTABLE**

Inclination and height.

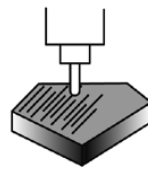

**MATERIAL**

Manufactured from billet aluminium and anodized.



**ADAPTABLE**

Specific available adapters for bike model.

MODEL	SIDE	REF.	D N
UNIVERSAL	RIGHT	21618	(*)
UNIVERSAL	LEFT	21618	(*)

(\*) Check price with your distributor.

**NOTE:** For handlebars with inner diameter of 13/18 mm. To see part# for the adaptors on the models available: **check website.**



# REARVIEW MIRROR FOLD



\* Check availability for motorcycle models at [www.puig.tv](http://www.puig.tv) typing in the searching window:

**FOLD**

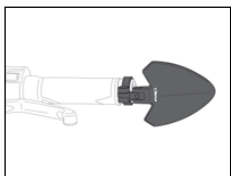
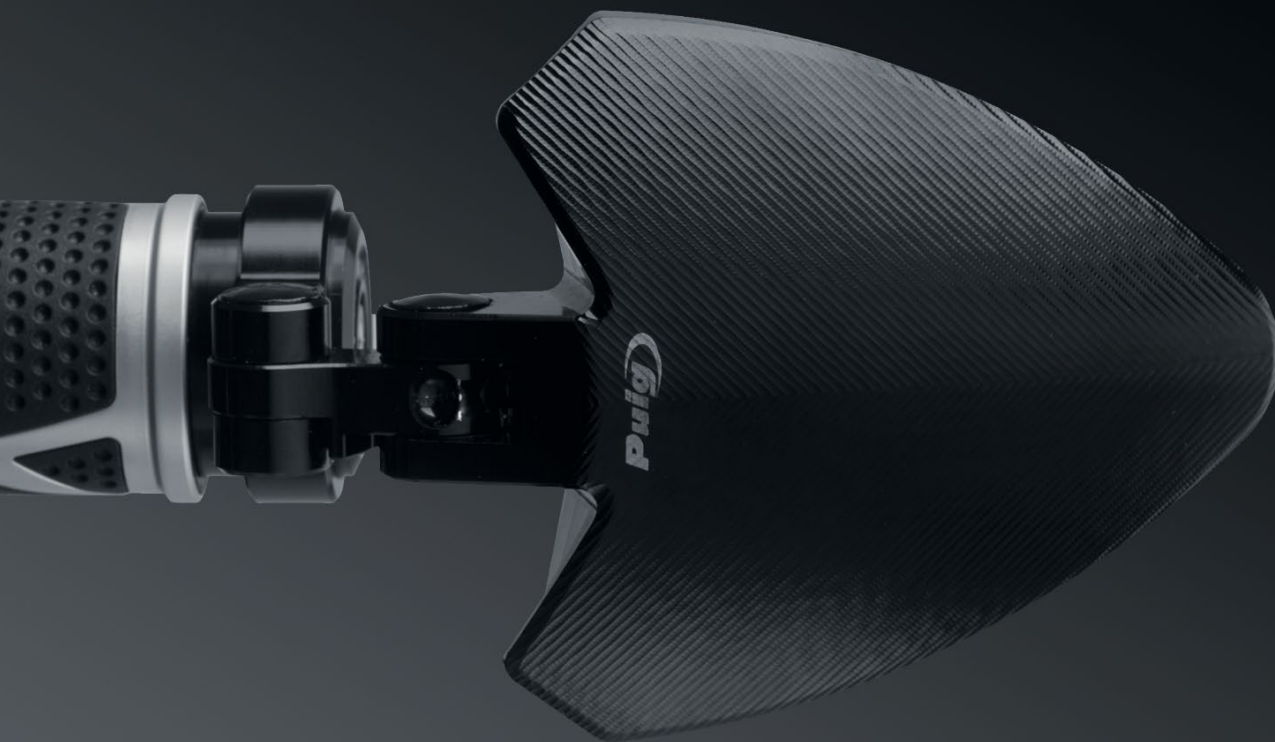

**D** Aluminium Anodized

**N** Black



Anti-reflective mirror.

**ANTI-GLARE**



Convex mirror, magnifying glass effect to increase vision.

**NOT HOMOLOGATED**

REF. 20859N

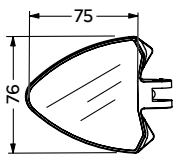
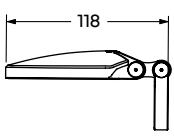

**DIMENSIONS**

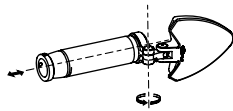

**ADJUSTABLE**

Inclination and height.

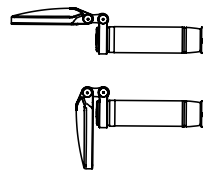

**FOLDABLE**

Suitable for diameter 22 mm.

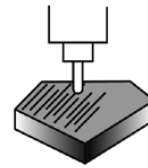

**MATERIAL**

Manufactured from billet aluminium and anodized.

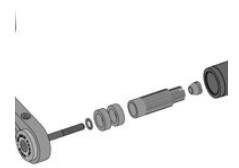

**ADAPTABLE**

Specific available adapters for bike model.

MODEL	SIDE	REF.	D N
UNIVERSAL	RIGHT	20859	(*)
UNIVERSAL	LEFT	20859	(*)

(\*) Check price with your distributor.

**NOTE:** For handlebars with inner diameter of 13/18 mm.  
To see part# for the adaptors on the models available: **check website.**

# REARVIEW MIRROR LOOK



\* Check availability for motorcycle models at [www.puig.tv](http://www.puig.tv) typing in the searching window:

**LOOK**

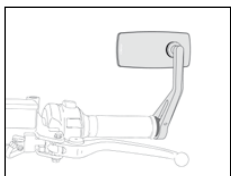

Anti-reflective mirror.

**ANTI-GLARE**



Convex mirror, magnifying glass effect to increase vision.

**D** Aluminium Anodized

**N** Black

**NOT HOMOLOGATED**



REF. 3764D

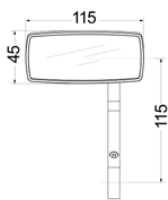

**DIMENSIONS**

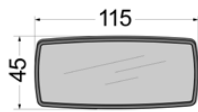

**ADJUSTABLE**

Inclination and height.

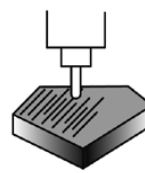

**MATERIAL**

Manufactured from billet aluminium and anodized.

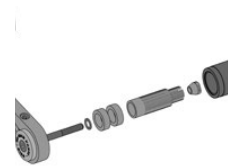

**ADAPTABLE**

Specific available adapters for bike model.

MODEL	SIDE	REF.	D N
UNIVERSAL	RIGHT	3764	(*)
UNIVERSAL	LEFT	3764	(*)

(\*) Check price with your distributor.

**NOTE:** For handlebars with inner diameter of 13/18 mm.  
To see part# for the adaptors on the models available: **check website.**



# REARVIEW MIRROR GRAND TRACKER



\* Check availability for motorcycle models at [www.puig.tv](http://www.puig.tv) typing in the searching window:

**GRAND TRACKER**



Mirror to fix to counterweight.



Anti-reflective mirror.



Convex mirror, magnifying glass effect to increase vision.

**D** Aluminium Anodized

**N** Black

**HOMOLOGATED**



REF. 9691D

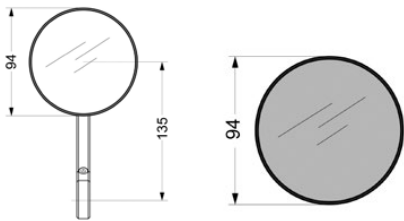

**DIMENSIONS**



**ADJUSTABLE**

Inclination and height.

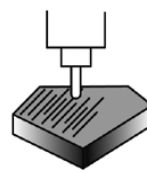

**MATERIAL**

Manufactured from billet aluminium and anodized.

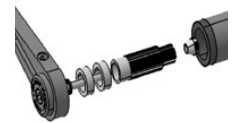

**ADAPTABLE**

Specific available adapters for bike model.

MODEL	SIDE	REF.	D N
UNIVERSAL	RIGHT	9691	(*)
UNIVERSAL	LEFT	9691	(*)

(\*) Check price with your distributor.

**NOTE:** For handlebars with inner diameter of 13/18 mm.  
To see part# for the adaptors on the models available: **check website.**

# REARVIEW MIRROR TRACKER



\* Check availability for motorcycle models at [www.puig.tv](http://www.puig.tv) typing in the searching window:

**TRACKER**

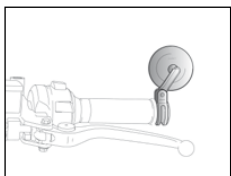

Mirror to fix to counterweight.



Anti-reflective mirror.



Convex mirror, magnifying glass effect to increase vision.

**D** Aluminium Anodized

**N** Black

**NOT HOMOLOGATED**



REF. 9506D

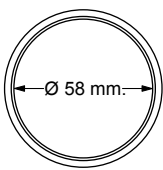

**DIMENSIONS**

Ø 58 mm.

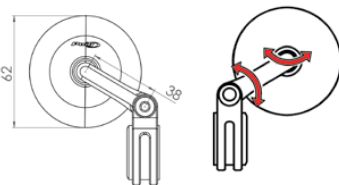

**ADJUSTABLE**

Inclination and height.

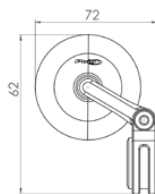

**ADAPTABLE**

To handlebar bar end.

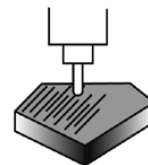

**MATERIAL**

Manufactured from billet aluminium and anodized.

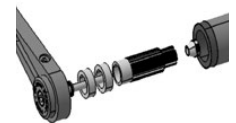

**ADAPTABLE**

Specific available adapters for bike model.

MODEL	SIDE	REF.	D N
UNIVERSAL	RIGHT	9506	(*)
UNIVERSAL	LEFT	9506	(*)

(\*) Check price with your distributor.

**NOTE:** For handlebars with inner diameter of 13/18 mm. To see part# for the adaptors on the models available: **check website.**



# REARVIEW MIRROR HI-TECH IV



\* Check availability for motorcycle models at [www.puig.tv](http://www.puig.tv) typing in the searching window:

**HITECH 4**

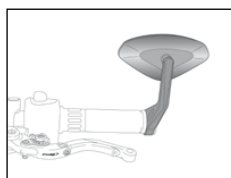

Mirror to fix to counterweight.



Anti-reflective mirror.

**ANTI-GLARE**



Convex mirror, magnifying glass effect to increase vision.

**D** Aluminium Anodized

**N** Black

**NOT HOMOLOGATED**



REF. 6994D

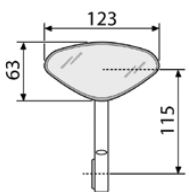

**DIMENSIONS**

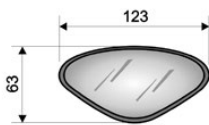

**ADJUSTABLE**

Inclination and height.

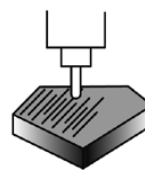

**MATERIAL**

Manufactured from billet aluminium and anodized.



**ADAPTABLE**

Specific available adapters for bike model.

MODEL	SIDE	REF.	D N
UNIVERSAL	RIGHT	6994	(*)
UNIVERSAL	LEFT	6994	(*)

(\*) Check price with your distributor.

**NOTE:** For handlebars with inner diameter of 13/18 mm.  
To see part# for the adaptors on the models available: **check website.**

# REARVIEW MIRROR MP



\* Check availability for motorcycle models at [www.puig.tv](http://www.puig.tv) typing in the searching window:

**MP**

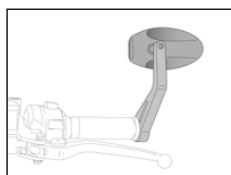

Mirror to fix to counterweight.



**ANTI-GLARE**

Anti-reflective mirror.



Convex mirror, magnifying glass effect to increase vision.

**N** Black

**P** Silver

**NOT HOMOLOGATED**



REF. 5220N

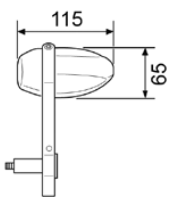

**DIMENSIONS**

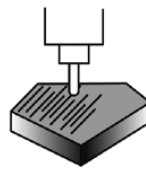
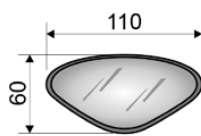

**MATERIAL**

Manufactured from billet aluminium and anodized.



**ADAPTABLE**

Specific available adapters for bike model.

MODEL	SIDE	REF.	N P
UNIVERSAL	RIGHT	5220	(*)
UNIVERSAL	LEFT	5220	(*)

(\*) Check price with your distributor.

**NOTE:** For handlebars with inner diameter of 13/18 mm.  
To see part# for the adaptors on the models available: **check website.**



# REARVIEW MIRROR MONACO



\* Check availability for motorcycle models at [www.puig.tv](http://www.puig.tv) typing in the searching window:

**MONACO**

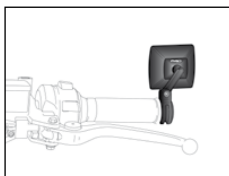

Mirror to fix to counterweight.



Anti-reflective mirror.



Convex mirror, magnifying glass effect to increase vision.

**D** Aluminium Anodized

**N** Black

**NOT HOMOLOGATED**



REF. 3668D



**DIMENSIONS**

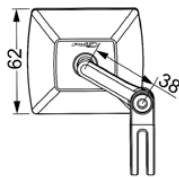

**ADJUSTABLE**

Inclination and height.

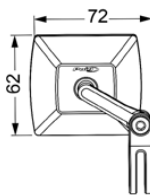
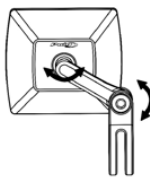

**ADAPTABLE**

To handlebar bar end.

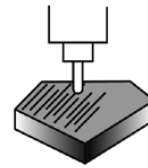

**MATERIAL**

Manufactured from billet aluminium and anodized.

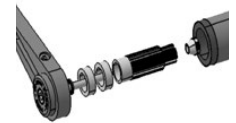

**ADAPTABLE**

Specific available adapters for bike model.

MODEL	SIDE	REF.	D N
UNIVERSAL	RIGHT	3668	(*)
UNIVERSAL	LEFT	3668	(*)

(\*) Check price with your distributor.

**NOTE:** For handlebars with inner diameter of 13/18 mm.  
To see part# for the adaptors on the models available: **check website.**

# REARVIEW MIRROR TOP-TECH I



\* Check availability for motorcycle models at [www.puig.tv](http://www.puig.tv) typing in the searching window:

**TOP TECH**

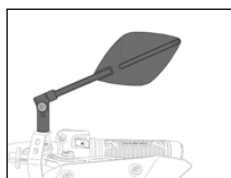
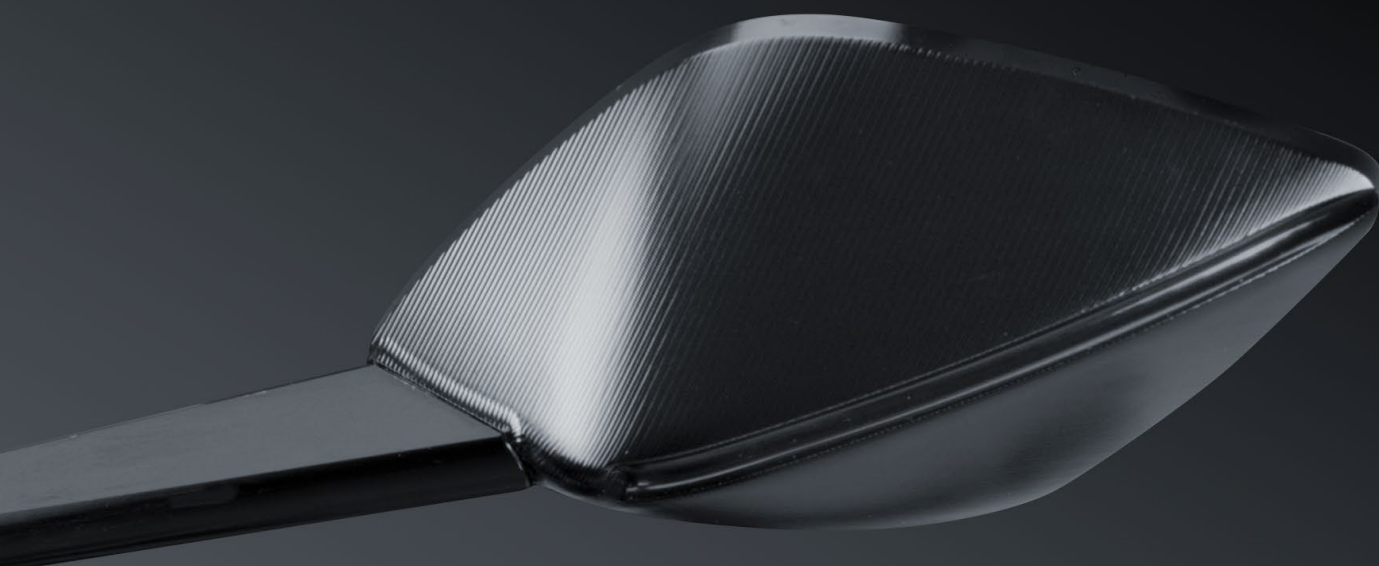

**D** Aluminium Anodized

**N** Black



**ANTI-GLARE**

Anti-reflective mirror.



Convex mirror, magnifying glass effect to increase vision.

HOMOLOGATED

REF. 21125N

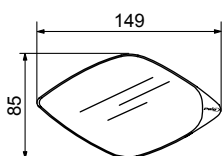
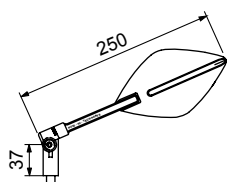

DIMENSIONS

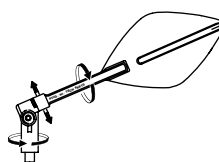

ADJUSTABLE

Inclination and height.

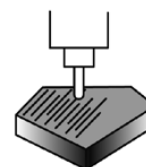

MATERIAL

Manufactured from billet aluminium and anodized.

MODEL	SIDE	REF.	D N
UNIVERSAL	RIGHT	21124 (#)	(*)
UNIVERSAL	LEFT	21125 (+)	(*)

(#) Screw M10/125 + M10/125 Reverse Thread + Screw M8/125 + M8/125 Reverse Thread.

(+) Screw M10/125 + Screw M8/125.

(\*) Check price with your distributor.

To see part# for the adaptors on the models available: **check website**.  
For those models requiring adaptors to attach to the fairing: **check website**.



# REARVIEW MIRROR RETRO



\* Check availability for motorcycle models at [www.puig.tv](http://www.puig.tv) typing in the searching window:

**BACK MIRROR RETRO**

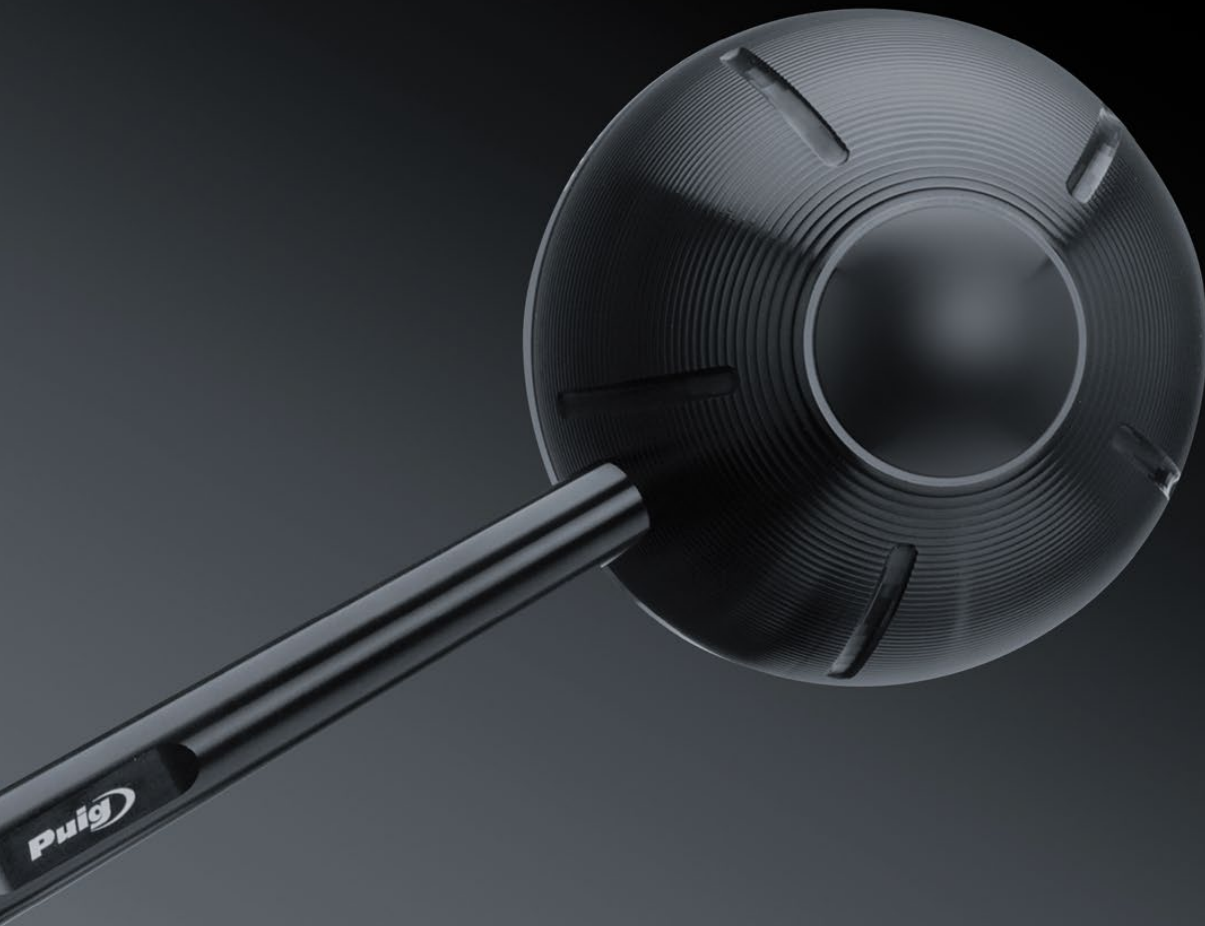

Anti-reflective mirror.

**ANTI-GLARE**



Convex mirror, magnifying glass effect to increase vision.

**D** Aluminium Anodized

**N** Black

**HOMOLOGATED**



REF. 9795D

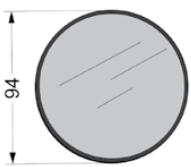

**DIMENSIONS**

Ø 94 mm.

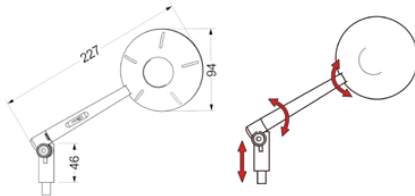

**ADJUSTABLE**

Inclination and height.

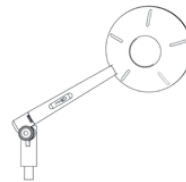

**ADAPTABLE**

To the handlebar and adapters available for the original fairing.

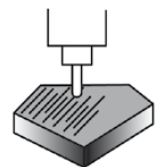

**MATERIAL**

Manufactured from billet aluminium and anodized.

MODEL	SIDE	REF.	D N
UNIVERSAL THREAD M10/125	RIGHT	9794 (#)	(*)
UNIVERSAL THREAD M10/125	LEFT	9795 (+)	(*)

(#) Screw M10/125 + M10/125 Reverse Thread + Screw M8/125 + M8/125 Reverse Thread.

(+) Screw M10/125 + Screw M8/125.

(\*) Check price with your distributor.

To see part# for the adaptors on the models available: **check website.**  
For those models requiring adaptors to attach to the fairing: **check website.**

# REARVIEW MIRROR HYPERNAKED



\* Check availability for motorcycle models at [www.puig.tv](http://www.puig.tv) typing in the searching window:

**HYPERNAKED**

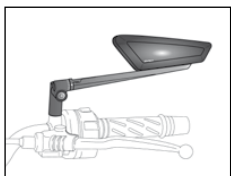

**D** Aluminium Anodized

**N** Black



**ANTI-GLARE**

Anti-reflective mirror.



Convex mirror, magnifying glass effect to increase vision.

**NOT HOMOLOGATED**

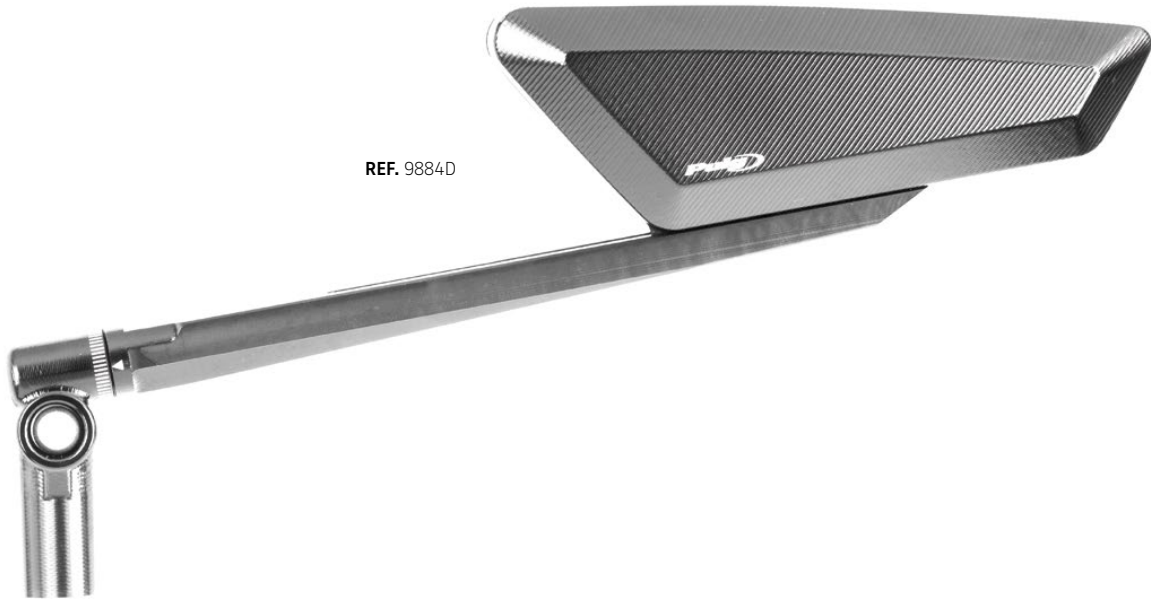

REF. 9884D

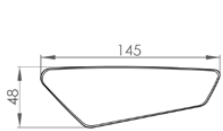

**DIMENSIONS**

145 x 48 mm.

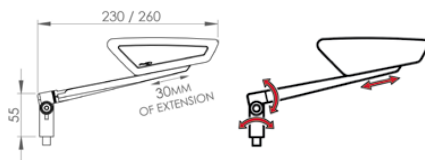

**ADJUSTABLE**

Inclination, adjustment, and extension of the mirror.

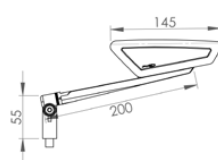

**ADAPTABLE**

Available adapters for handlebar and fairing fitting.

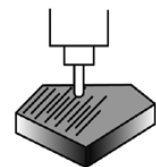

**MATERIAL**

Manufactured from billet aluminium and anodized.

MODEL	SIDE	REF.	D N
UNIVERSAL THREAD M10/125	RIGHT	9883 (#)	(*)
UNIVERSAL THREAD M10/125	LEFT	9884 (+)	(*)

(#) Screw M10/125 + M10/125 Reverse Thread + Screw M8/125 + M8/125 Reverse Thread.

(+) Screw M10/125 + Screw M8/125.

(\*) Check price with your distributor.

To see part# for the adaptors on the models available: **check website**.  
For those models requiring adaptors to attach to the fairing: **check website**.



# REARVIEW MIRROR EXPLORER



\* Check availability for motorcycle models at [www.puig.tv](http://www.puig.tv) typing in the searching window:

**EXPLORER**

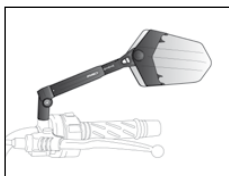
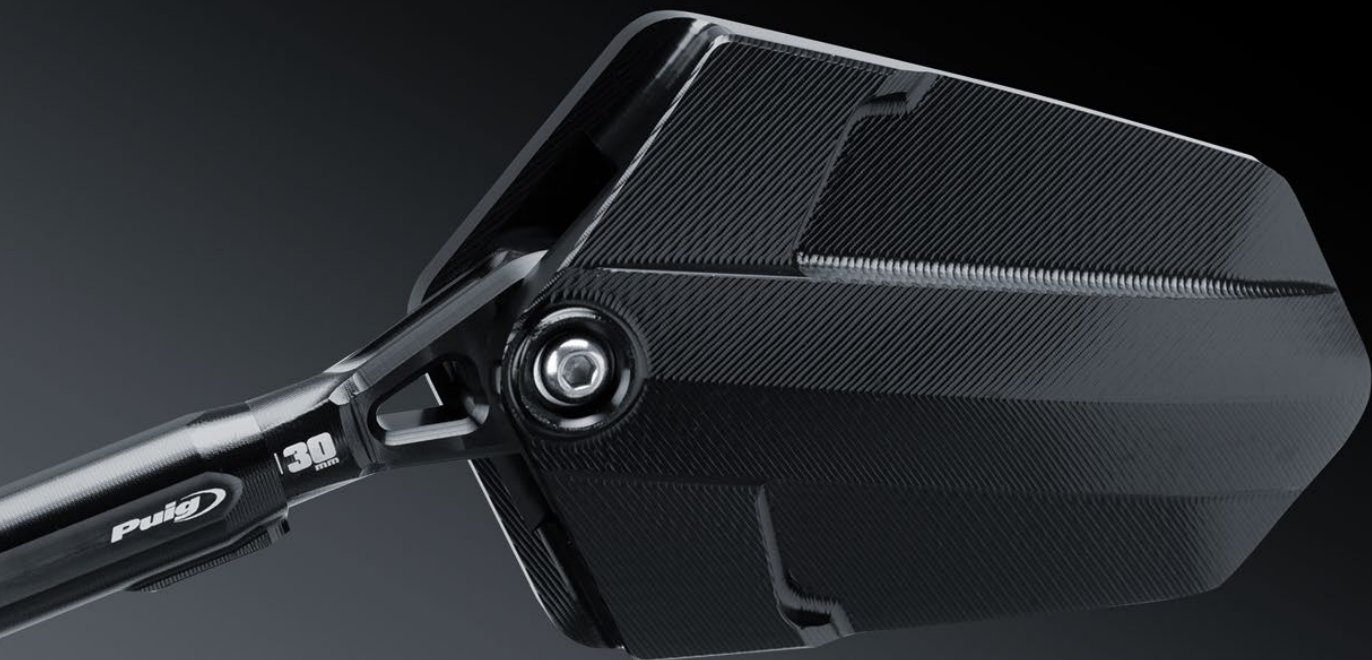

**D** Aluminium Anodized

**N** Black



**ANTI-GLARE**

Anti-reflective mirror.



Convex mirror, magnifying glass effect to increase vision.

**HOMOLOGATED**

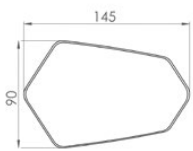

**DIMENSIONS**

145 x 90 mm.

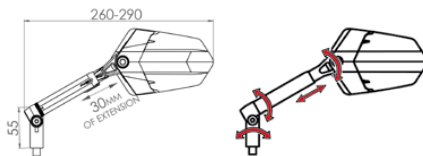

**ADJUSTABLE**

Inclination, adjustment, and extension of the mirror.

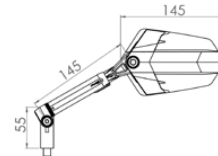

**FOLDABLE**

Available adapters for handlebar and fairing fitting.

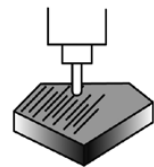

**MATERIAL**

Manufactured from billet aluminium and anodized.

MODEL	SIDE	REF.	D N
UNIVERSAL THREAD M10/125	RIGHT	010NN <b>(1) (#)</b>	(*)
UNIVERSAL THREAD M10/125	RIGHT	010DD <b>(2) (#)</b>	(*)
UNIVERSAL THREAD M10/125	RIGHT	010DN <b>(3) (#)</b>	(*)
UNIVERSAL THREAD M10/125	RIGHT	010ND <b>(4) (#)</b>	(*)
UNIVERSAL THREAD M10/125	LEFT	014NN <b>(1) (+)</b>	(*)
UNIVERSAL THREAD M10/125	LEFT	014DD <b>(2) (+)</b>	(*)
UNIVERSAL THREAD M10/125	LEFT	014DN <b>(3) (+)</b>	(*)
UNIVERSAL THREAD M10/125	LEFT	014ND <b>(4) (+)</b>	(*)

**(#)** Screw M10/125 + M10/125 Reverse Thread + Screw M8/125 + M8/125 Reverse Thread.

**(+)** Screw M10/125 + Screw M8/125.

**(\*)** Check price with your distributor.

To see part# for the adaptors on the models available: **check website**.  
For those models requiring adaptors to attach to the fairing: **check website**.

# REARVIEW MIRROR GT.1



\* Check availability for motorcycle models at [www.puig.tv](http://www.puig.tv) typing in the searching window:

**GT.1**

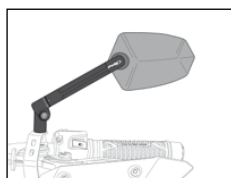

**D** Aluminium Anodized

**N** Black



**ANTI-GLARE**

Anti-reflective mirror.



Convex mirror, magnifying glass effect to increase vision.

**HOMOLOGATED**

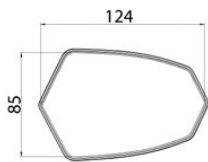

**DIMENSIONS**

124 x 85 mm.

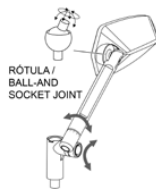

**ADJUSTABLE**

Inclination and height.

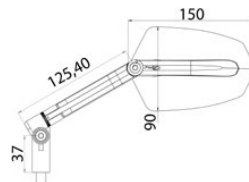

**FOLDABLE**

Available adapters for handlebar and fairing fitting.

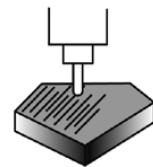

**MATERIAL**

Manufactured from billet aluminium and anodized.

MODEL	SIDE	REF.	D N
UNIVERSAL THREAD M10/125	RIGHT	020NN (1) (#)	(*)
UNIVERSAL THREAD M10/125	RIGHT	020DD (2) (#)	(*)
UNIVERSAL THREAD M10/125	RIGHT	020DN (3) (#)	(*)
UNIVERSAL THREAD M10/125	RIGHT	020ND (4) (#)	(*)
UNIVERSAL THREAD M10/125	LEFT	019NN (1) (+)	(*)
UNIVERSAL THREAD M10/125	LEFT	019DD (2) (+)	(*)
UNIVERSAL THREAD M10/125	LEFT	019DN (3) (+)	(*)
UNIVERSAL THREAD M10/125	LEFT	019ND (4) (+)	(*)

(#) Screw M10/125 + M10/125 Reverse Thread + Screw M8/125 + M8/125 Reverse Thread.

(+) Screw M10/125 + Screw M8/125.

(\*) Check price with your distributor.

To see part# for the adaptors on the models available: **check website.**  
For those models requiring adaptors to attach to the fairing: **check website.**



# REARVIEW MIRROR GTI



\* Check availability for motorcycle models at [www.puig.tv](http://www.puig.tv) typing in the searching window.

**GTI**



**ANTI-GLARE**

Anti-reflective mirror.



Convex mirror, magnifying glass effect to increase vision.

**D** Aluminium Anodized

**N** Black

**HOMOLOGATED**

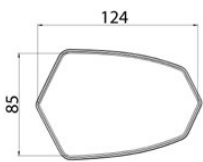

**DIMENSIONS**

124 x 85 mm.

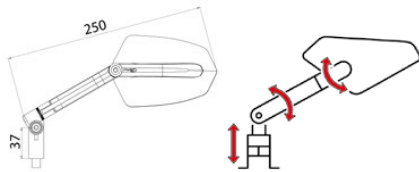

**ADJUSTABLE**

Inclination, adjustment, and extension of the mirror.

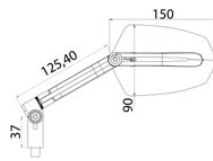

**FOLDABLE**

Available adapters for handlebar and fairing fitting.

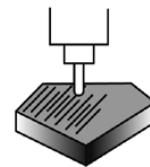

**MATERIAL**

Manufactured from billet aluminium and anodized.

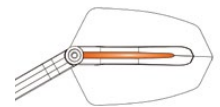

**TURN SIGNAL INTEGRATED**

**MODEL**

MODEL	SIDE	REF.	D N
UNIVERSAL THREAD M10/125	RIGHT	015ND <b>(1) (#)</b>	(*)
UNIVERSAL THREAD M10/125	RIGHT	015DD <b>(2) (#)</b>	(*)
UNIVERSAL THREAD M10/125	RIGHT	015DN <b>(3) (#)</b>	(*)
UNIVERSAL THREAD M10/125	RIGHT	015ND <b>(4) (#)</b>	(*)
UNIVERSAL THREAD M10/125	LEFT	016NN <b>(1) (+)</b>	(*)
UNIVERSAL THREAD M10/125	LEFT	016DD <b>(2) (+)</b>	(*)
UNIVERSAL THREAD M10/125	LEFT	016DN <b>(3) (+)</b>	(*)
UNIVERSAL THREAD M10/125	LEFT	016ND <b>(4) (+)</b>	(*)

**(#)** Screw M10/125 + M10/125 Reverse Thread + Screw M8/125 + M8/125 Reverse Thread.

**(+)** Screw M10/125 + Screw M8/125.

**(\*)** Check price with your distributor.

To see part# for the adaptors on the models available: **check website**.  
For those models requiring adaptors to attach to the fairing: **check website**.

# REARVIEW MIRROR F1.1



\* Check availability for motorcycle models at [www.puig.tv](http://www.puig.tv) typing in the searching window:

**F1.1**

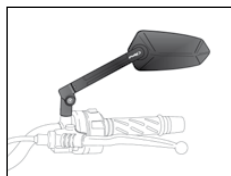

**D** Aluminium Anodized

**N** Black



**ANTI-GLARE**

Anti-reflective mirror.

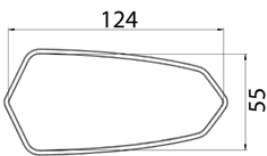

Convex mirror, magnifying glass effect to increase vision.

**NOT HOMOLOGATED****DIMENSIONS**

124 x 55 mm.

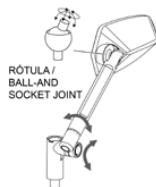
**ADJUSTABLE**

Inclination and height.

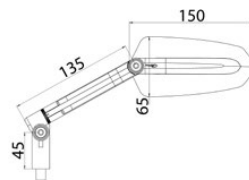
**FOLDABLE**

Available adapters for handlebar and fairing fitting.

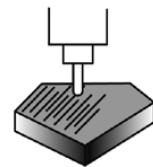
**MATERIAL**

Manufactured from billet aluminium and anodized.

MODEL	SIDE	REF.	D N
UNIVERSAL THREAD M10/125	RIGHT	017NN (1) (#)	(*)
UNIVERSAL THREAD M10/125	RIGHT	017DD (2) (#)	(*)
UNIVERSAL THREAD M10/125	RIGHT	017DN (3) (#)	(*)
UNIVERSAL THREAD M10/125	RIGHT	017ND (4) (#)	(*)
UNIVERSAL THREAD M10/125	LEFT	018NN (1) (+)	(*)
UNIVERSAL THREAD M10/125	LEFT	018DD (2) (+)	(*)
UNIVERSAL THREAD M10/125	LEFT	018DN (3) (+)	(*)
UNIVERSAL THREAD M10/125	LEFT	018ND (4) (+)	(*)

(#) Screw M10/125 + M10/125 Reverse Thread + Screw M8/125 + M8/125 Reverse Thread.

(+ ) Screw M10/125 + Screw M8/125.

(\*) Check price with your distributor.

To see part# for the adaptors on the models available: **check website**.  
For those models requiring adaptors to attach to the fairing: **check website**.



# REARVIEW MIRROR Z3



\* Check availability for motorcycle models at [www.puig.tv](http://www.puig.tv) typing in the searching window:

**Z3**



**ANTI-GLARE**

Anti-reflective mirror.



Convex mirror, magnifying glass effect to increase vision.

**N** Black

**HOMOLOGATED**

**NEW!**

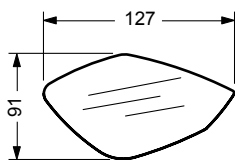

**DIMENSIONS**

127 x 91 mm.

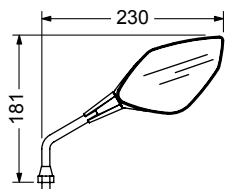

**DIMENSIONS**

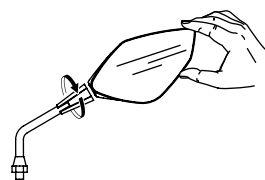

**ADJUSTABLE**

Allows regulation by hand.

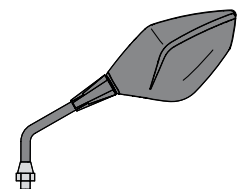

**MATERIAL**

Made of plastic.

MODEL	SIDE	REF.	N
(1) UNIVERSAL WITH BAR	RIGHT	21821	(*)
(2) UNIVERSAL 30° FAIRING FITTING	RIGHT	21823	(*)
(3) UNIVERSAL FAIRING FITTING	RIGHT	21825	(*)
(4) UNIVERSAL 70° FAIRING FITTING	RIGHT	21827	(*)
(1) UNIVERSAL WITH BAR	LEFT	21822	(*)
(2) UNIVERSAL 30° FAIRING FITTING	LEFT	21824	(*)
(3) UNIVERSAL FAIRING FITTING	LEFT	21826	(*)
(4) UNIVERSAL 70° FAIRING FITTING	LEFT	21828	(*)

(\*) Inklus kit adaptadores: M10 x 1,25RH, M10 x 1,25LH, M8 x 1,25RH, M8 x 1,25LH.

(\*) Check price with your distributor.

To see part# for the adaptors on the models available: **check website.**

# REARVIEW MIRROR Z2



\* Check availability for motorcycle models at [www.puig.tv](http://www.puig.tv) typing in the searching window:

**Z2**

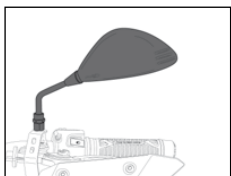

**ANTI-GLARE**

Anti-reflective mirror.



Convex mirror, magnifying glass effect to increase vision.

**N** Black

**HOMOLOGATED**

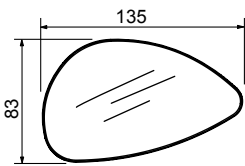

**DIMENSIONS**

135 x 83 mm.

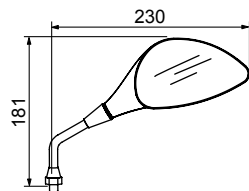

**DIMENSIONS**

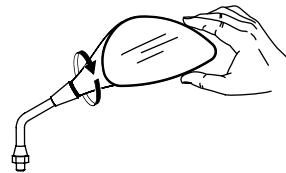

**ADJUSTABLE**

Inclination and height.



**MATERIAL**

Made of plastic.

MODEL	SIDE	REF.	N
(1) UNIVERSAL WITH BAR	RIGHT	3574 (#)	(*)
(2) UNIVERSAL 30° FAIRING FITTING	RIGHT	3576	(*)
(3) UNIVERSAL FAIRING FITTING	RIGHT	3578	(*)
(4) UNIVERSAL 70° FAIRING FITTING	RIGHT	3580	(*)
(1) UNIVERSAL WITH BAR	LEFT	3575 (#)	(*)
(2) UNIVERSAL 30° FAIRING FITTING	LEFT	3577	(*)
(3) UNIVERSAL FAIRING FITTING	LEFT	3579	(*)
(4) UNIVERSAL 70° FAIRING FITTING	LEFT	3581	(*)

(#) Includ kit adaptadores: M10 x 1,25RH, M10 x 1,25LH, M8 x 1,25RH, M8 x 1,25LH.

(\*) Check price with your distributor.

To see part# for the adaptors on the models available: **check website.**



# MIRROR VIEW THREAD TRIM PLUG



\* Check availability for motorcycle models at [www.puig.tv](http://www.puig.tv) typing in the searching window:

**MIRROR HOLE SCREW**



**A** Blue  
**N** Black

**O** Gold  
**P** Silver

**R** Red  
**T** Orange

**V** Green

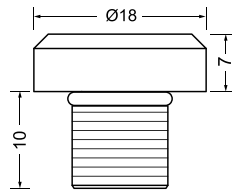
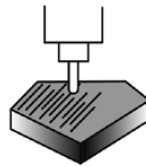
**NEW!****DIMENSIONS****MATERIAL**

Manufactured from billet aluminium and anodized.

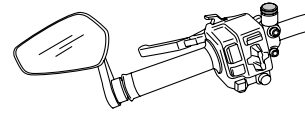
**LOOK**

Decorative function: Covers the threaded holes of the handlebar mirror support.

MODEL	THREAD	REF.	A N O P R T V
M10/125 MIRROR VIEW CAP SET (*)	RIGHT + RIGHT	21808	(*)
M10/150 MIRROR VIEW CAP SET	RIGHT + RIGHT	21805	(*)
M10/125 MIRROR VIEW CAP SET (+)	RIGHT + LEFT	21804	(*)
M8/125 MIRROR VIEW CAP SET	RIGHT + LEFT	21803	(*)

(\*) Check price with your distributor.

(\*) In this part number, two plugs with right-hand thread are supplied.  
If your motorcycle has left thread on the right side, order part number 21804.

(+) In this part number, a right-hand screw cap and a left-hand screw cap are supplied.  
If your motorcycle has right-hand thread on both sides, order part number 21808.



# ORIGINAL REARVIEW MIRRORS CAPS, SUPPORT AND SHIFTER



**A** Blue  
**N** Black

**O** Gold  
**R** Red

REF. 7511N



## BASE CAPS FOR OEM REAR MIRRORS BY PAIR



\* Check availability for motorcycle models at [www.puig.tv](http://www.puig.tv) typing in the searching window:

**PAIR CAPS**

REF. 5021N



## REARVIEW MIRROR MOVE SET

MODEL	SIDE	REF.	N
UNIVERSAL REAR MIRROR MOVE SET DIAMETER 10 mm.	LEFT	5021N (#)	(*)
UNIVERSAL REAR MIRROR MOVE SET DIAMETER 10 mm.	RIGHT	5021N (#)	(*)

(#) 3 cm. between the holes.



\* Check availability for motorcycle models at [www.puig.tv](http://www.puig.tv) typing in the searching window:

**REARVIEW MIRROR MOVE SET**

REF. 7517N



## ADAPTOR TO AXLE LEVER



\* Check availability for motorcycle models at [www.puig.tv](http://www.puig.tv) typing in the searching window:

**REARVIEW MIRROR SUPPORT**



# REARVIEW MIRROR CAPS



\* Check availability for motorcycle models at [www.puig.tv](http://www.puig.tv) typing in the searching window:

**MIRRORS CAPS**





REF. 3845N

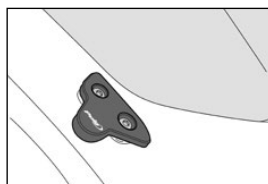

REF. 3847N

**FUNCTION**

Cover the holes in the fairing when the original mirrors are removed. Specific models for each motorcycle.

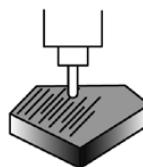
**CNC MACHINED**

Machined and anodized aluminum cover in black with a design that integrates perfectly into the motorcycle.



The bikers who are most proud of their machines take care of them down to the last detail. The smallest elements can make all the difference. The Puig mirror covers will achieve a clean and well-finished image in case the mirrors are removed to enter the circuit.



# MIRROR COVERS WITH TURN SIGNALS



\* Check availability for motorcycle models at [www.puig.tv](http://www.puig.tv) typing in the searching window:

**MIRROR COVERS**



On type R motorcycles that will incorporate the turn signal in the mirror, if you want to mount the mirrors with bar end, you need the rearview mirror cover to include a turn signal. In this case, we incorporate our Tab model flasher.

■ N Black

**NEW!**



**REF. 21814N**  
\* Turn signal TAB not included.

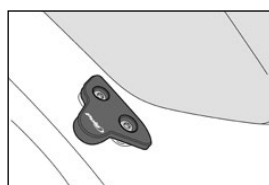
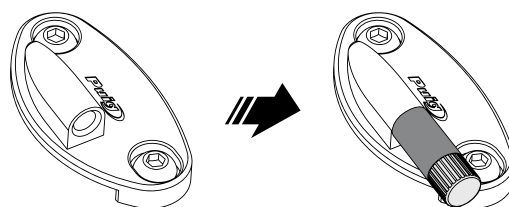

**FUNCTION**

Cover the holes in the fairing when the original mirrors are removed. Specific models for each motorcycle.

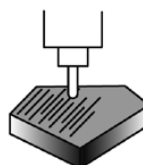

**CNC MACHINED**

Machined and anodized aluminum cover in black with a design that integrates perfectly into the motorcycle.



**HOMOLOGATED**

**TAB**

MODEL	REF.	N
SET BLACK CLEAR LENSES LED Ø10 x 10 mm. 12V 1W Thread: M6	21749N	(*)

(\*) Check price with your distributor.

**TURN SIGNAL**



# MOTORCYCLE HANDGUARDS



\* Check availability for motorcycle models at [www.puig.tv](http://www.puig.tv) typing in the searching window:

**HANDGUARDS**



- J Matt black
- N Black

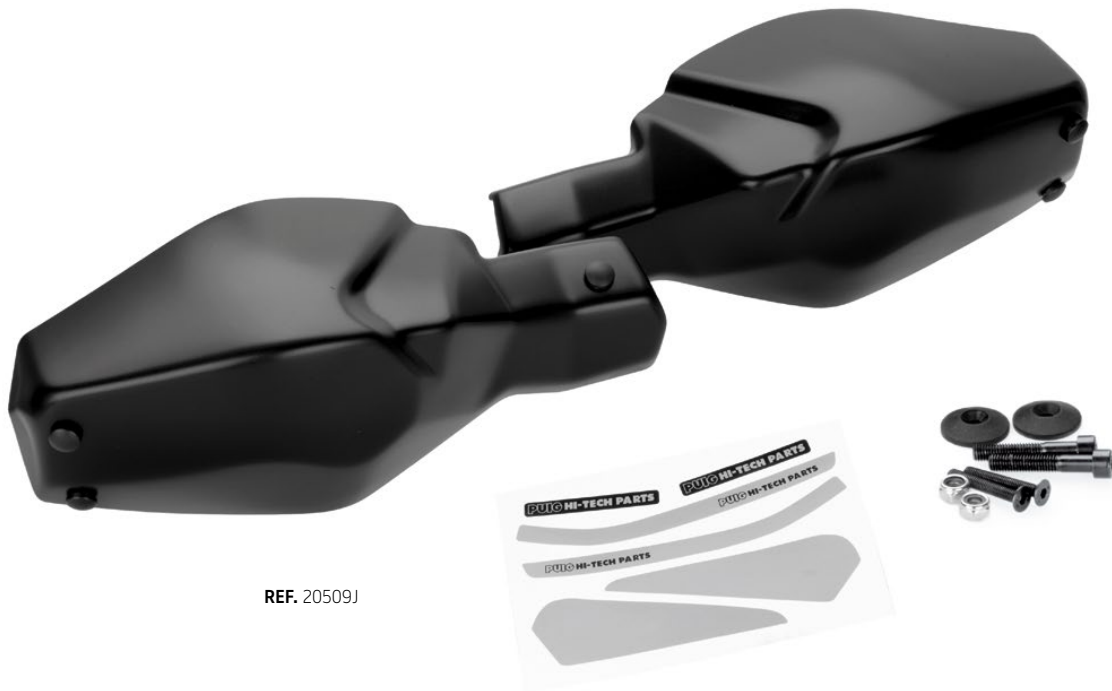

REF. 20509J

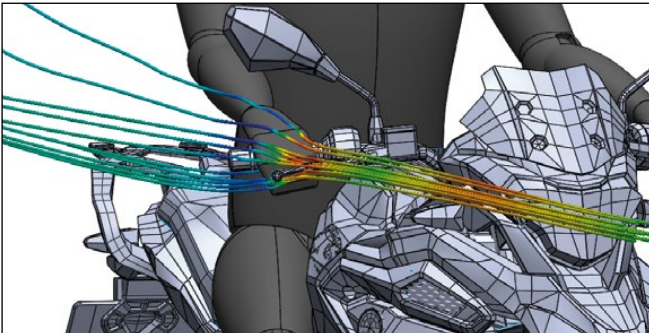
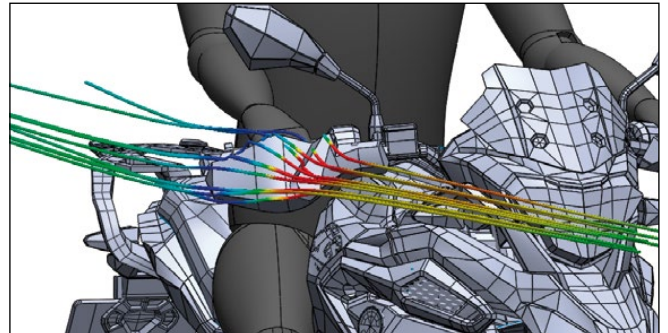
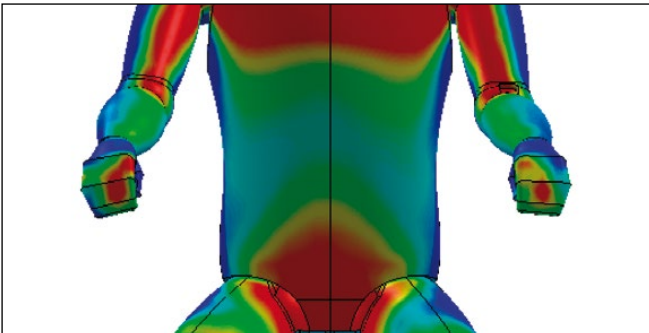
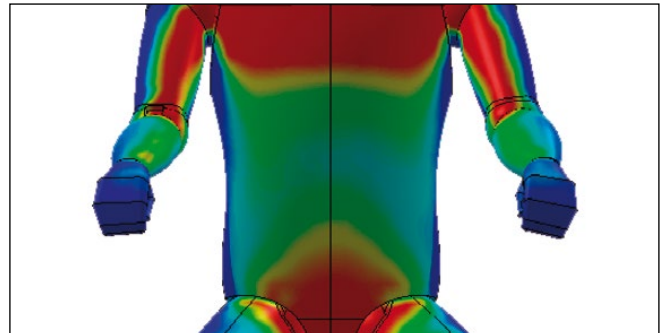
**OEM****PUIG****OEM****PUIG**

Puig offers a wide range of handguards for those motorcycles that do not have them. Manufactured in a matt black plastic material. They are light, durable and matching your motorcycle lines.

Designed with the best aerodynamic software to protect your hands and arms from the rain, air and possible small impacts from small rocks or insects.

Adhesive kit is served for certain models of handguards. For some motorcycle models we have a Sport model.

# MOTORCYCLE HANDGUARD EXTENSIONS



\* Check availability for motorcycle models at [www.puig.tv](http://www.puig.tv) typing in the searching window:

**HANDGUARDS**



F Dark Smoke  
 H Smoke

T Orange  
 W Clear

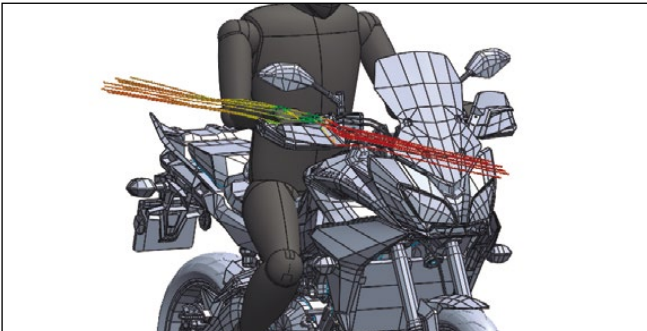
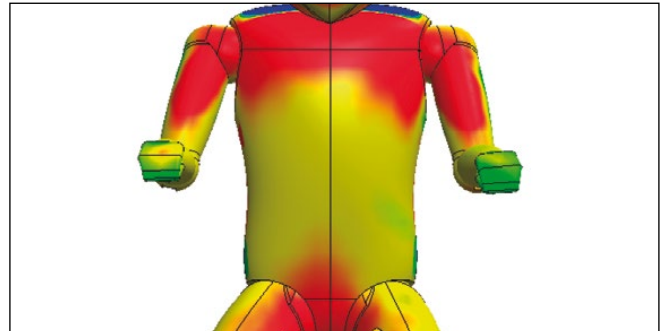
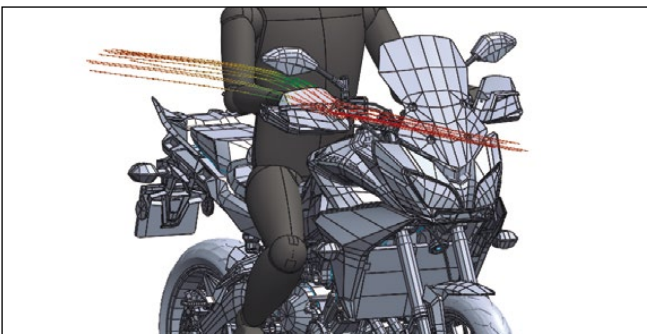
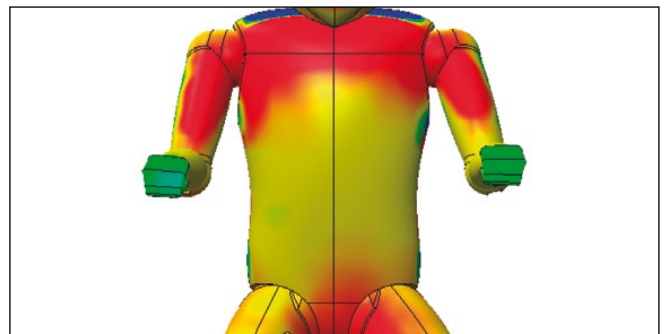

REF. 20378W

**OEM****OEM****PUIG****PUIG**

The Puig handguard extension is a product destined to the client that looks for maximum protection or that suffers from the impact of the wind on his arms and shoulders.

These small and discrete parts have been specially designed through a comprehensive aerodynamic study to redirect air flow, water or small impacts to your upper arms and thus offering the best riding comfort.



# MAXISCOOTER HANDGUARDS



\* Check availability for motorcycle models at [www.puig.tv](http://www.puig.tv) typing in the searching window:

**HANDGUARDS**



**F** Dark Smoke

**H** Smoke

**W** Clear

REF. 3488F

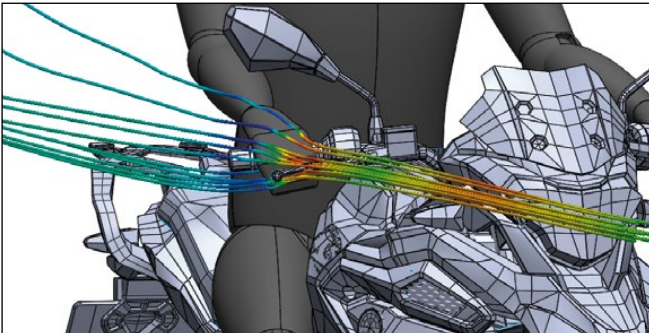
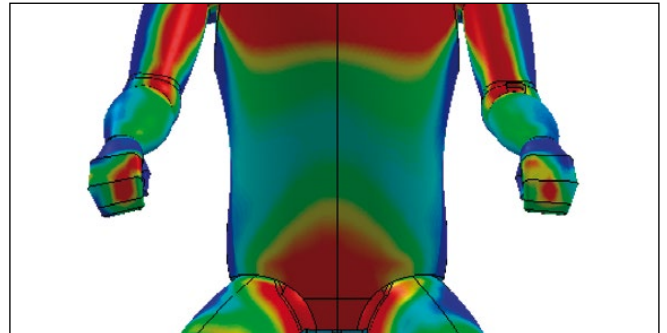
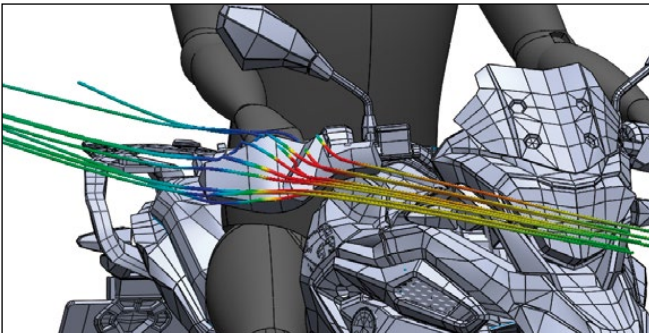
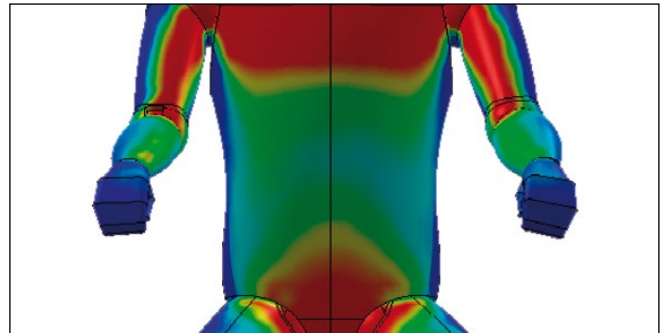
**OEM****OEM****PUIG****PUIG**

Puig offers a line of handguards for Scooters and Maxiscoters. They are fabricated in very durable material, they are light and made with soft and discrete lines that will match your motorcycle perfectly.

Designed with the best aerodynamic software to protect your hands and arms from the rain, air and possible small impacts from small rocks or insects.

Available in three shades, smoke, dark smoke and clear.

# HANDLEBAR DEFLECTORS



\* Check availability for motorcycle models at [www.puig.tv](http://www.puig.tv) typing in the searching window:

**HANDLEBAR DEFLECTORS**



**F** Dark Smoke

**H** Smoke

**W** Clear



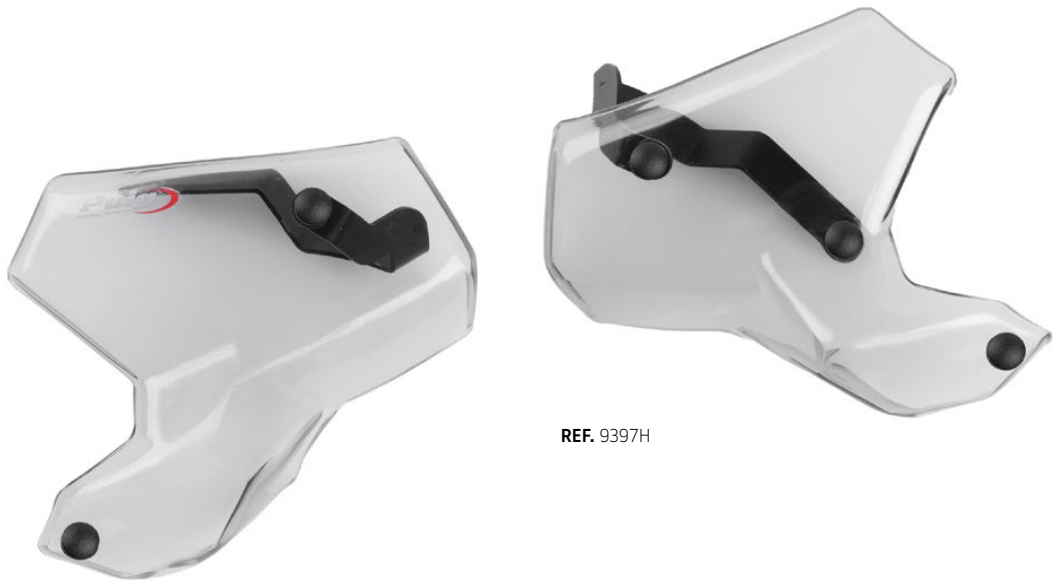

REF. 9397H



REF. 1319H



Exclusive product for BMW models that allow the direct impact of the air to be diverted on the rider's torso while riding, reducing fatigue and giving the motorcycle a new aerodynamic line. In addition, they protect sensitive parts of the motorcyclist such as the shoulders.



# MOBILE PHONE SUPPORT



\* Check availability for motorcycle models at [www.puig.tv](http://www.puig.tv) typing in the searching window:

**PHONE HOLDER**





REF. 3836N

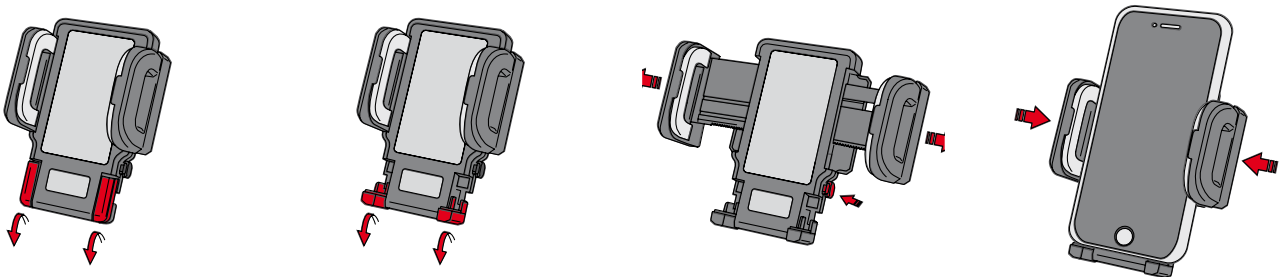

## HORIZONTAL SMARTPHONE PHONE HOLDER

MODEL	DIMENSIONS (mm.)	REF.	N
UNIVERSAL			
MOBILE PHONE SUPPORT	500 x 500 -1150	3836N	(*)

(\*) Check price with your distributor.

Thanks to the Puig phone holder you can use your smartphone as a browser without suffering for its integrity and security. In addition, in our catalog you will find a line of accessories related to your mobile phone and its protection during journeys of all kinds and with different weather scenarios.

The support will allow you to integrate your phone comfortably and without affecting the final visibility of the road. The locking mechanism adapts to the inches of today's phones. The padded area on the sides and the back, where it rests, improves its grip, and prevents vibration that could affect its operating system.

You can mount the phone holder on the base of the mirror, the mirror rod, on the handlebar and on the seat post of the motorcycle where it will be more immobilized against possible impacts or potholes on the road.

# MOBILE CASE



\* Check availability for motorcycle models at [www.puig.tv](http://www.puig.tv) typing in the searching window.

**PHONE CASE**





## LARGE MOBILE CASE

MODEL	DIMENSIONS (mm.)	REF.	N
UNIVERSAL			
MOBILE CASE	185 x 100 x 30	3531N	(*)

## SMALL MOBILE CASE

MODEL	DIMENSIONS (mm.)	REF.	N
UNIVERSAL			
MOBILE CASE	165 x 100 x 30	3530N	(*)



## IN-TAKE CHARGE

MODEL	REF.	N
(1) IN-TAKE CHARGE C/BLACK	6390N	(*)
(2) USB IN-TAKE CHARGE N/BLACK INPUT:12v OUTPUT:2,5A Light Consumption 0.01 mA	6840N	(*)



# MOBILE SUPPORTS



\* Check availability for motorcycle models at [www.puig.tv](http://www.puig.tv) typing in the searching window.

**MOBILE SUPPORTS**





REF. 20516N

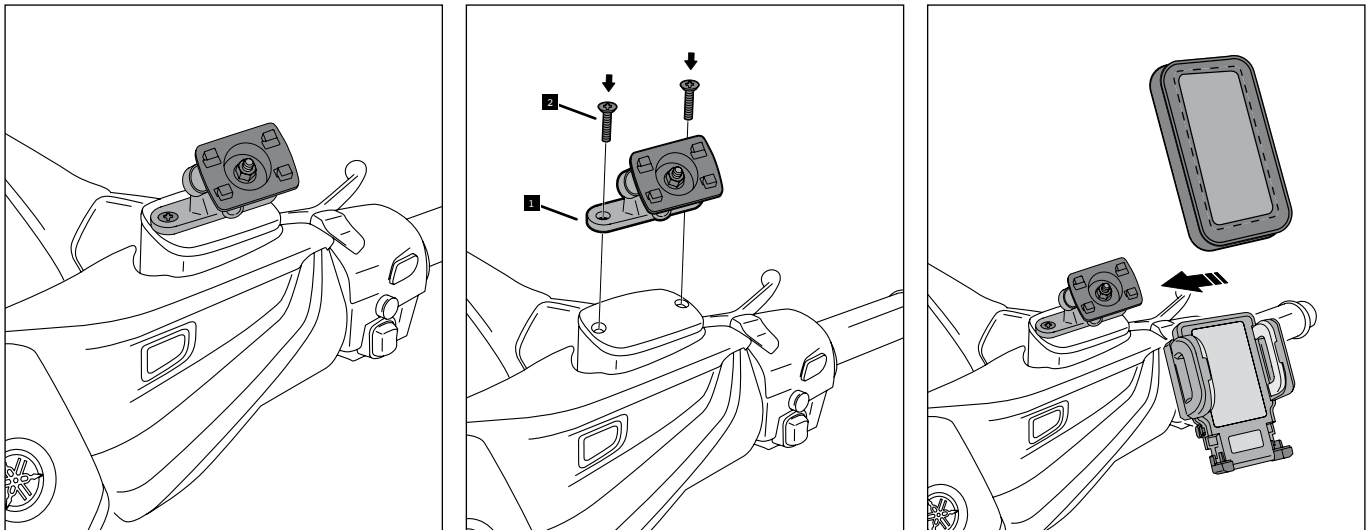

## SUPPORT BRAKE-CLUTCH LIQUID CAP

MODEL	REF.	N
SUPPORT BRAKE-CLUTCH LIQUID CAP	CHECK WEB	(*)

(\*) Check price with your distributor.

Specific support for certain motorcycle models made of aluminum and anodized in black. It is fixed on the upper part of the front brake expansion tank cover ensuring good visibility of the device and the motorcycle control panel.

**Compatible with the mobile phone holder Ref.3836N and the Puig Motoplastic quick-fix covers Ref.3530N and 3531N.**

Available for a wide range of models, consult adjustability to the motorcycle model in the web.

# MOBILE SUPPORTS



\* Check availability for motorcycle models at [www.puig.tv](http://www.puig.tv) typing in the searching window.

**MOBILE SUPPORTS**





REF. 3570P

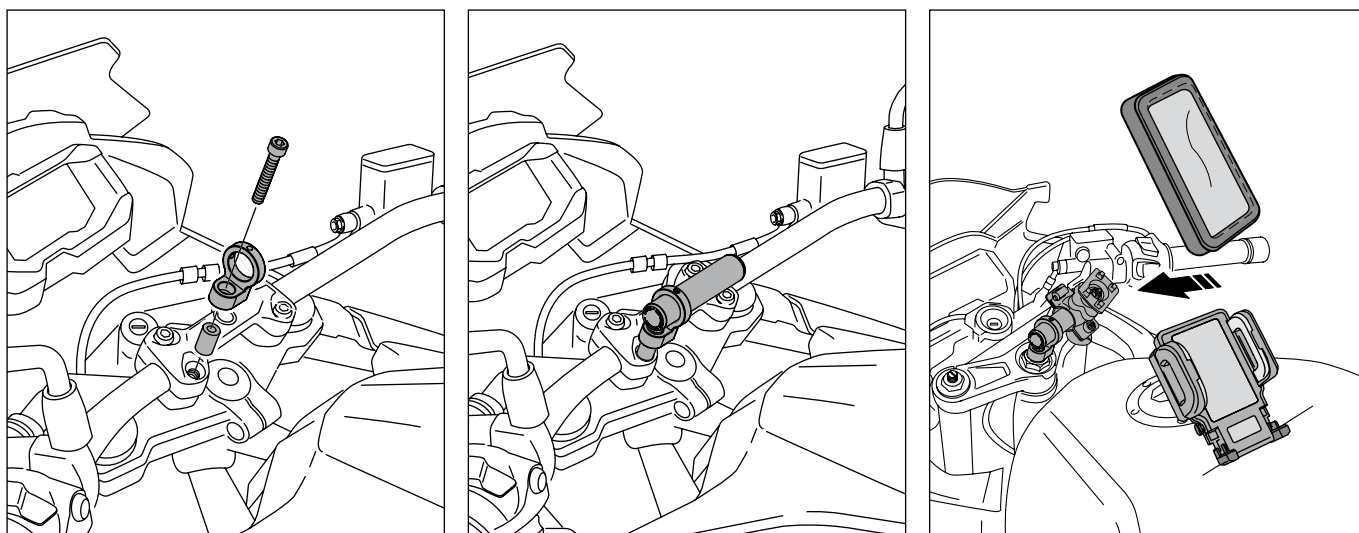

## RISERS HANDLEBAR SUPPORT

MODEL	REF.	P
HANDLEBAR BAR SUPPORT	3570P	(*)

(\*) Check price with your distributor.

Smartphone mount of superior quality, with machined parts in billet aluminium and anodized in silver color. Diameter of the tube is 20 mm. and 80 mm. in length which allows the attachment of several products such as GPS, cel phone, etc. It attaches easily and quickly. It is offered with screws in different lengths to adapt it to any motorcycle.

**It requires that you buy the 3534N support. Compatible with the mobile phone holder Ref.3836N and the Puig Motoplástico quick-fix covers Ref.3530N and 3531N.**

Available for a wide range of models, consult adjustability to the motorcycle model in the web.



# MOBILE SUPPORTS



\* Check availability for motorcycle models at [www.puig.tv](http://www.puig.tv) typing in the searching window:

**MOBILE SUPPORTS**



■ N Black

□ P Silver



REF. 3756N



REF. 3756P

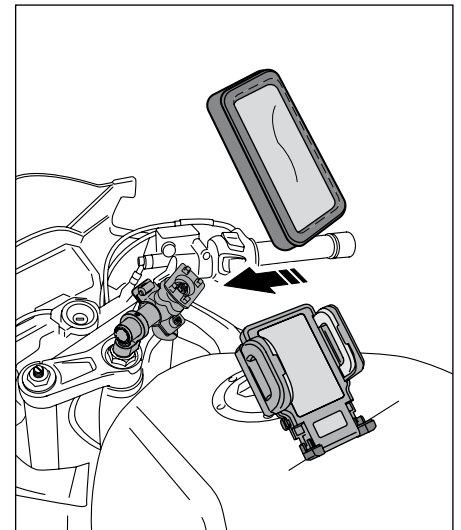
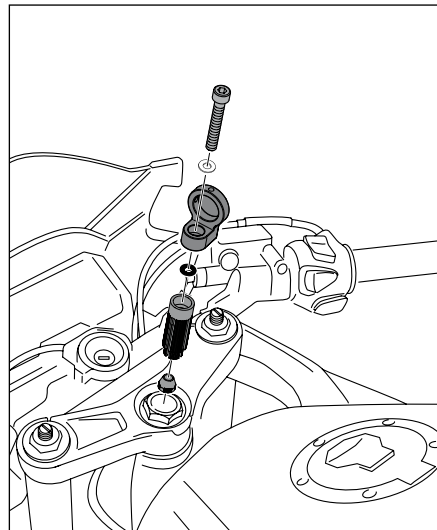
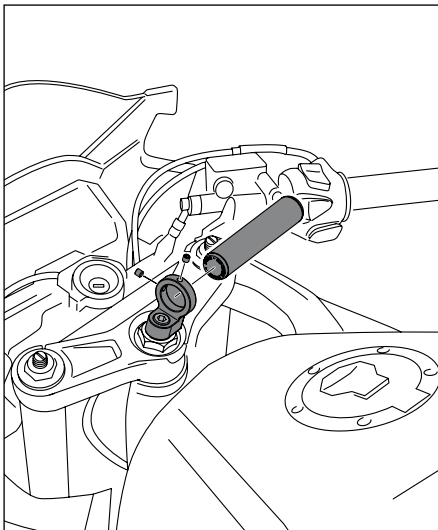

## SUPPORT TO CENTRAL HOLE YOKE

### MODEL

UNIVERSAL

### REF.

3756N

### N P

(\*)

SUPPORT TO CENTRAL HOLE YOKE

(\*) Check price with your distributor.

Universal support for Sport motorcycles. It is fixed in the center of the yoke axle. Allows you to adjust the inclination and lateral movement. It consists of a machined aluminum body in silver or black, with a bar of the same color and a plastic support with an adjustable hemisphere that allows a quick adjustment without tools.

It can be mounted on any motorcycle that has a hole in the yoke axle (or a plug) with dimensions between  $\varnothing 13$  and  $\varnothing 18$ , where the stamping pin will pass. Easy to assemble.

**Compatible with the mobile phone holder Ref.3836N and the Puig Motoplastic quick-fix covers Ref.3530N and 3531N. Check the compatibility of the motorcycle at Puig Motoplastic website.**

Available for a wide range of models, consult adjustability to the motorcycle model in the web.

# MOBILE SUPPORTS



\* Check availability for motorcycle models at [www.puig.tv](http://www.puig.tv) typing in the searching window:

**MOBILE SUPPORTS**

REF. 3534N

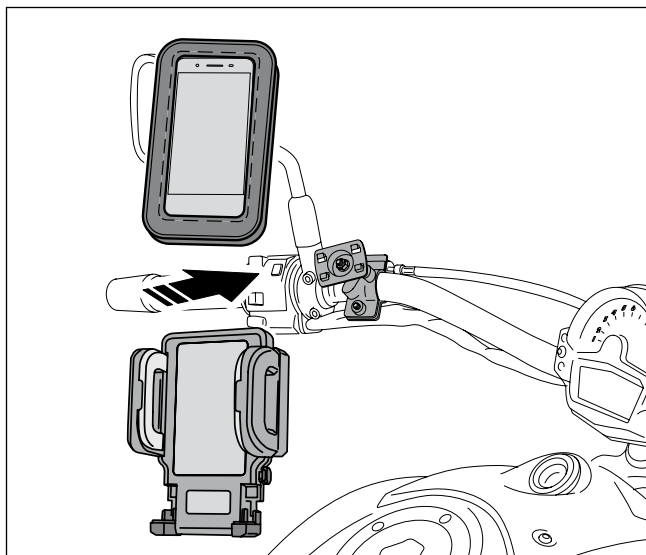

## HANDLEBAR

MODEL	REF.	N
UNIVERSAL		
HANDLEBAR BRACKET	3534N	(*)

This element allows you to directly adjust the support for the Smartphone to the handlebar of the motorcycle. It is made out of two halves that adjust to each other with the handlebar in between, while they adjusted through a thumbscrew. We also offer different thickness rubber spacers, so that it ends up perfectly adjusted to the motorcycle.

**Compatible with the mobile phone holder Ref.3836N and the Puig Motoplástico quick-fix covers Ref.3530N and 3531N.**

This part is good for any handlebar that has a diameter of Ø20 until Ø25 mm. and just like any of our supports, it is compatible with our cel phone covers.



REF. 3532N

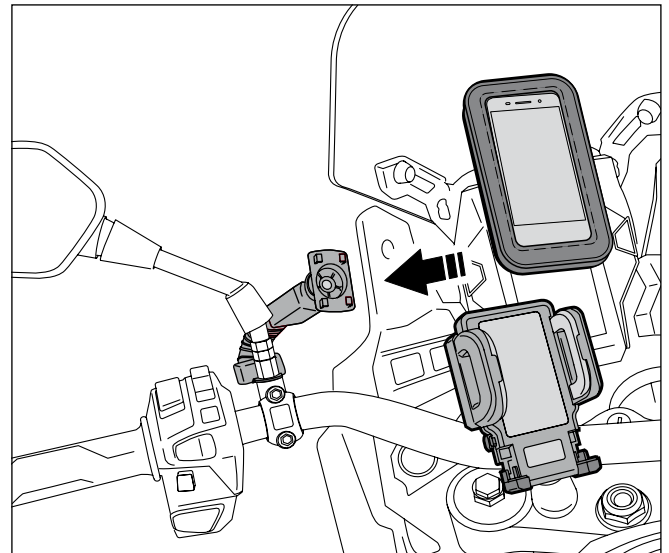

## REARVIEW MIRROR BASE

MODEL	REF.	N
UNIVERSAL		
REARVIEW BASE SUPPORT M8/M10	3532N	(*)

Support for the rearview mirror base, it is an universal support with complete mobility, 360° and also allows 100% adjustability to guarantee the best view during the ride, so the rider doesn't lose focus of the road.

**Compatible with the mobile phone holder Ref.3836N and the Puig Motoplastic quick-fix covers Ref.3530N and 3531N.**

The support is made of a metal base and a semi-rigid arm that guarantees a perfect attachment to the base of the rearview mirror. This support is good for all those motorcycle models that carry the rearview mirrors over the handlebars and are also compatible with Puig's covers.



REF. 3533N

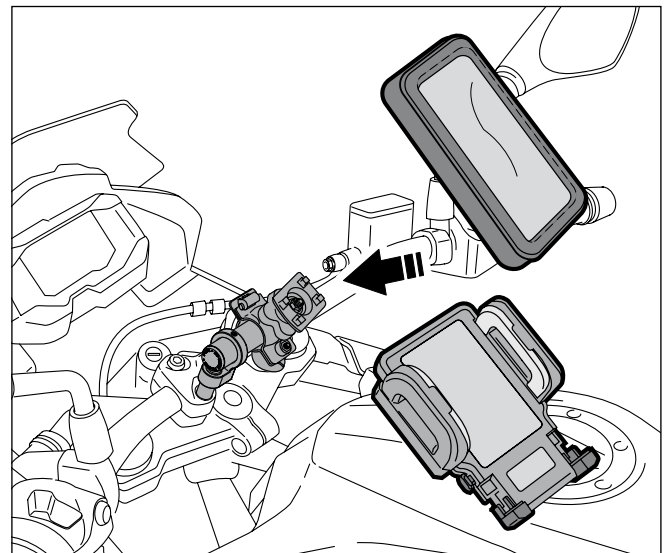

## REARVIEW MIRROR ROD

MODEL	REF.	N
UNIVERSAL		
REAR VIEW MIRROR SUPPORT	3533N	(*)

A support of easy and quick application, where the plastic cover hugs the rearview mirror rod and it is attached by a thumbscrew. It is offered with different rubber spacers, of different thickness, to adapt it to the different motorcycles needs.

**Compatible with the mobile phone holder Ref.3836N and the Puig Motoplastic quick-fix covers Ref.3530N and 3531N.**

This support is good for mounting over any rearview mirror with a cylindrical rod of Ø9 until Ø25 and just like the last one it is compatible with our covers.



# 3



# GAS TANK AREA

ADHESIVE NAKED YOKE & TANK PADS	278
ADHESIVE RADIKAL YOKE & TANK PADS	282
ADHESIVE TANK PADS SET	290
ADHESIVE X-TREME YOKE & TANK PADS	286
GRIPPING PADS	315
HANDHOLDS	274
MARC MÁRQUEZ TANK PADS	276
SCRATCH PADS PROTECTOR	316
SHEETS	315
SPIRIT TANK PADS	302
TANK PADS BIKE / F-YOU / MUGELLO	311
TANK PADS CHALLENGE	294
TANK PADS DREI	295
TANK PADS FUTURE / VIOLENT	304
TANK PADS JOKER / CLOWN	309
TANK PADS MINI / ARROW	313
TANK PADS MOON / SCREAM	308
TANK PADS PERFORMANCE	296
TANK PADS PERFORMANCE 2	297
TANK PADS SCARY / GIRL	306
TANK PADS SKULL / SKULL I / COLOURY	312
TANK PADS SKULL & POKER / CASINO	307
TANK PADS SKULL PARTY / SKULL PARTY BLACK & WHITE / ROCK & ROLL	310
TANK PADS SOFT / GRASP	299
TANK PADS SPIRIT II / ONE	305
TANK PADS TIRE / LEATHER	298
TANK PADS WAY / SUN	314
TANK SIDE PROTECTORS ANTI-SLIP	292
WINGS TANK PADS	300

# HANDHOLDS



\* Check availability for motorcycle models at [www.puig.tv](http://www.puig.tv) typing in the searching window.

**HOLDERS**



Improve the comfort and grip of your passengers on the motorcycle with the Puig universal seats. Made of lightweight aluminum and black EPOXY paint, it will be the best complement to improve the passenger journey, taking care of and preserving the aesthetics of your bike to the maximum.



REF. 9039N

The handles are fixed, by means of screws, to the tank cap of the motorcycle. The model that best fits your vehicle will be determined by the number of screws needed to fix it to the tank cap.

It is recommended that you check the number of screws for fixing the part on your motorcycle before purchasing the product.



# MARC MÁRQUEZ TANK PADS



\* Check availability for motorcycle models at [www.puig.tv](http://www.puig.tv) typing in the searching window:

**MARC MARQUEZ**



 C Carbon look

 W Clear



## 93

MODEL	REF.	C W
93 CARBON LOOK	20682C	(*)
93 CLEAR	20682W	(*)



## BIG ANT

MODEL	REF.	C W
BIG ANT CARBON LOOK	20681C	(*)
BIG ANT CLEAR	20681W	(*)



## MM93

MODEL	REF.	C W
MM93 CARBON LOOK	20683C	(*)
MM93 CLEAR	20683W	(*)

# ADHESIVE NAKED YOKE & TANK PADS



\* Check availability for motorcycle models at [www.puig.tv](http://www.puig.tv) typing in the searching window:

**TANKPAD NAKED**



U Grey



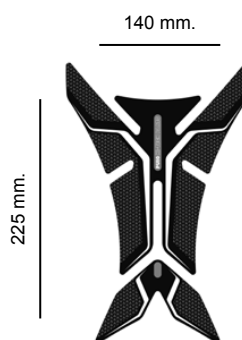

**TANK PAD**

MODEL	REF.	U
UNIVERSAL	6291U	(*)



**PLUG DEPOSIT PROTECTOR**

MODEL	REF.	U
SPECIFIC MODELS (#)	CHECK WEB	(*)

(#) Drawings of all fuel cap protectors available see page 280.



**YOKE PROTECTOR**

MODEL	REF.	U
SPECIFIC MODELS	CHECK WEB	(*)



# NAKED FUEL CAP COVER

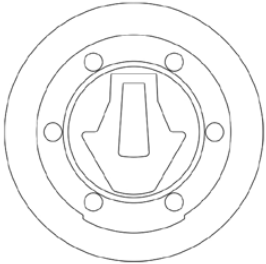

3698

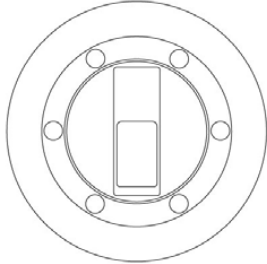

6293

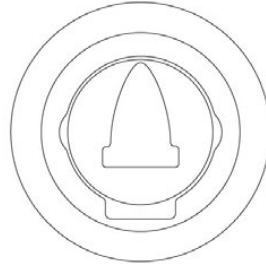

6295

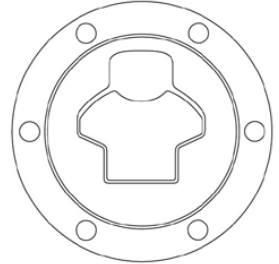

6297

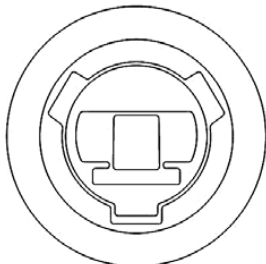

6299

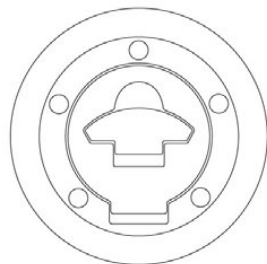

6303

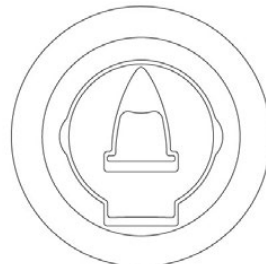

6305



6307

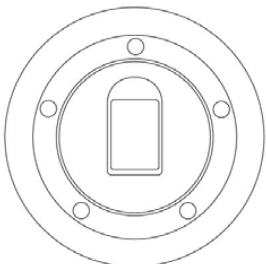

6309

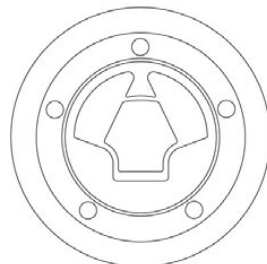

6311

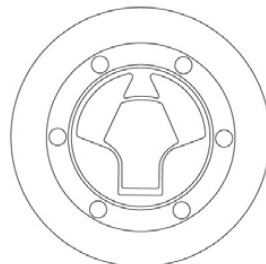

6313

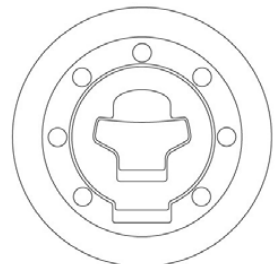

6315

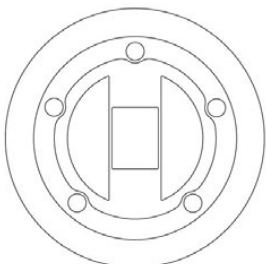

6317

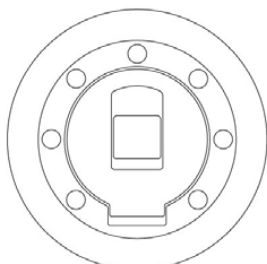

6321

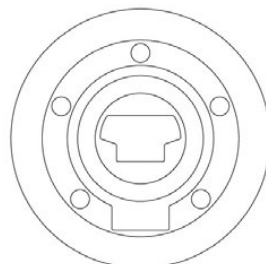

6323

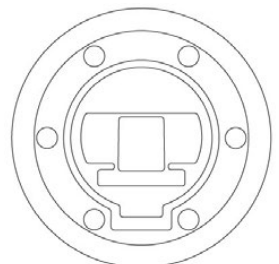

6824

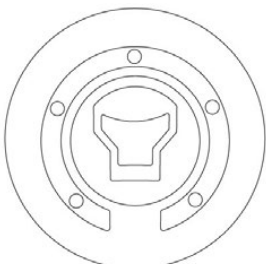

7571



7583

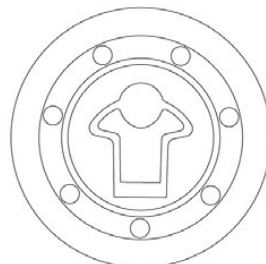

7610

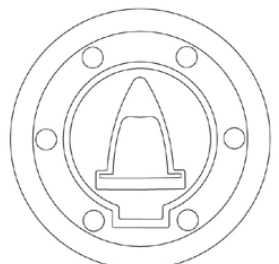

8172

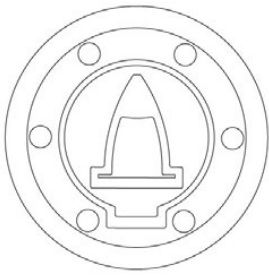

8236

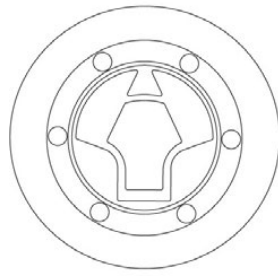

8242

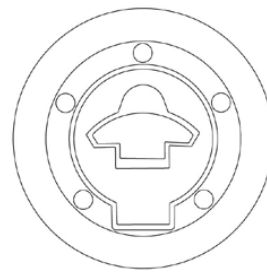

8254

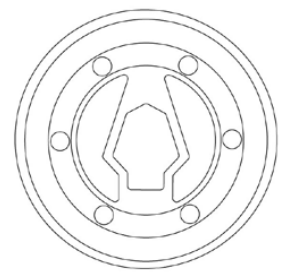

8968

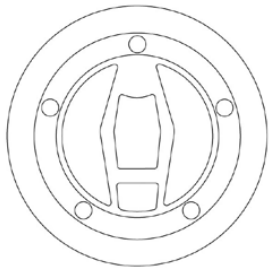

8976

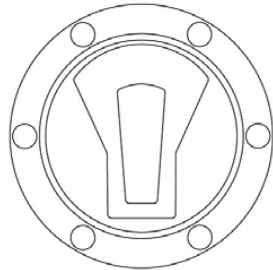

8978

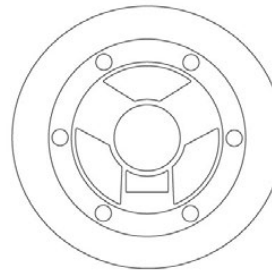

8980

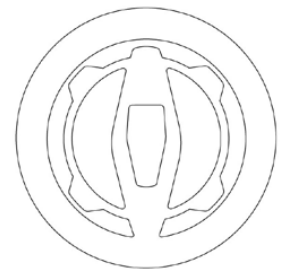

9361

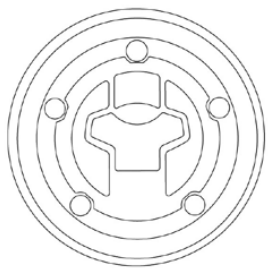

9428



9446

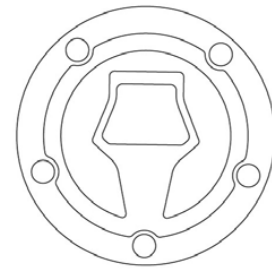

9608



9964

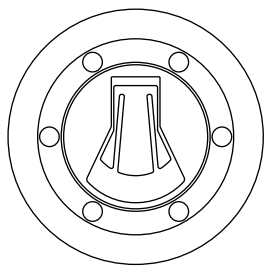

20613

**IMPORTANT:** We recommend verify the design of the cap with the above diagrams when ordering.

# ADHESIVE RADIKAL YOKE & TANK PADS



\* Check availability for motorcycle models at [www.puig.tv](http://www.puig.tv) typing in the searching window:

**TANKPAD RADIKAL**



**A** Blue

**R** Red

**U** Grey

**V** Green





**TANK PAD**

MODEL	REF.	A R U V
UNIVERSAL	6292	(*)



**PLUG DEPOSIT PROTECTOR**

MODEL	REF.	A R U V
SPECIFIC MODELS (#)	CHECK WEB	(*)

(#) Drawings of all fuel cap protectors available see page 284.

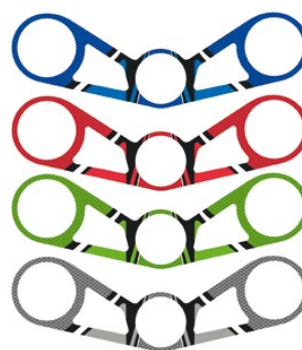

**YOKE PROTECTOR**

MODEL	REF.	A R U V
SPECIFIC MODELS	CHECK WEB	(*)



# FUEL CAP COVER RADIKAL

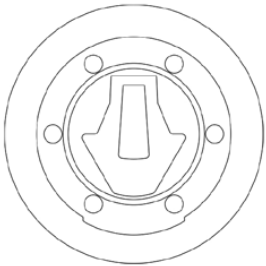

3696

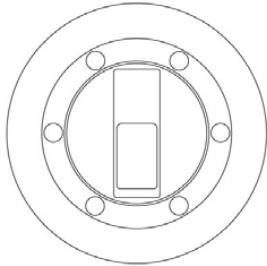

6294

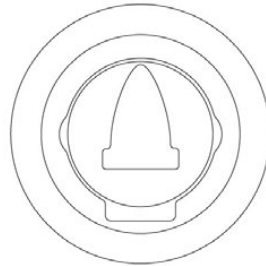

6296

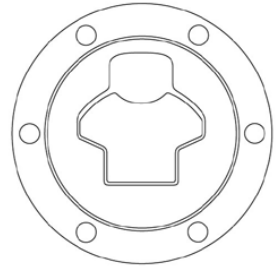

6298

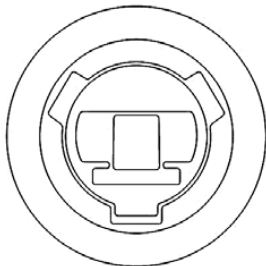

6300

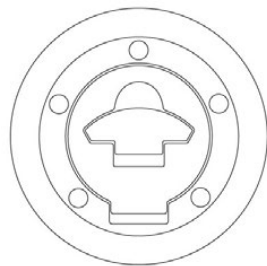

6304

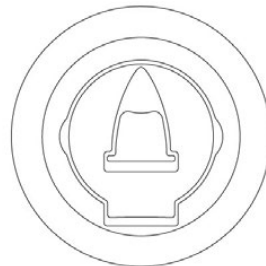

6306



6308

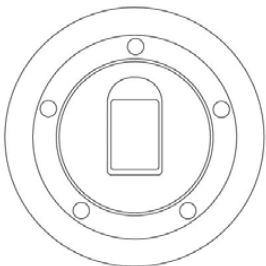

6310

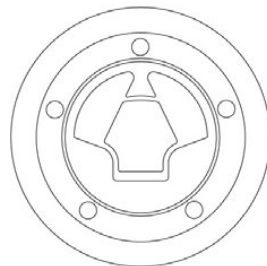

6312

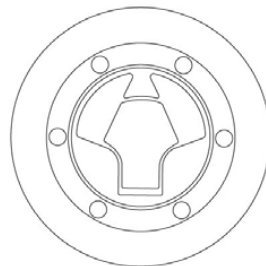

6314

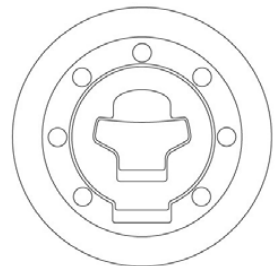

6316

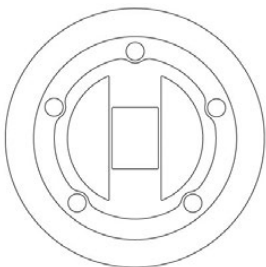

6318

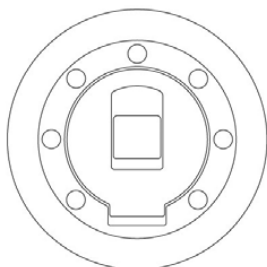

6322

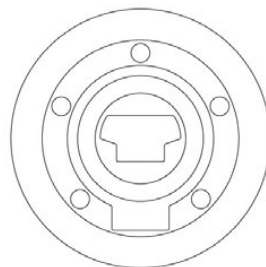

6324

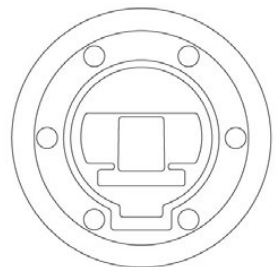

6825

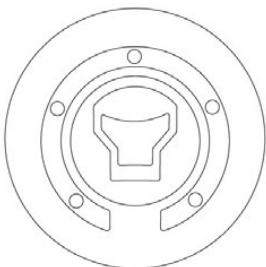

7572



7584

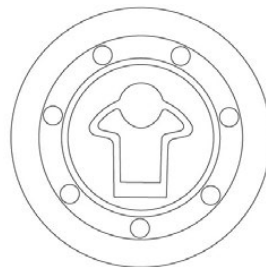

7611

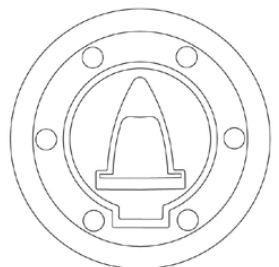

8174

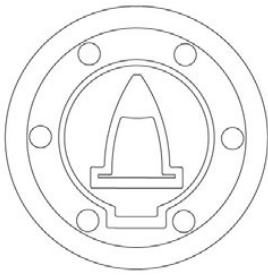

8263

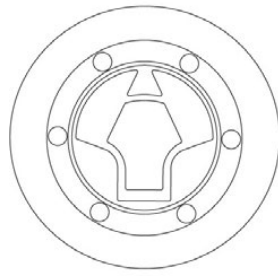

8269

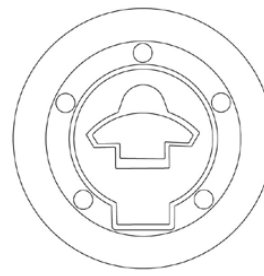

8281

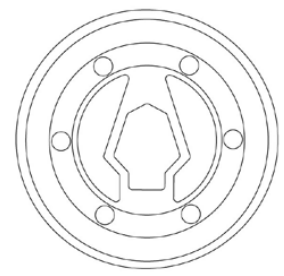

9041

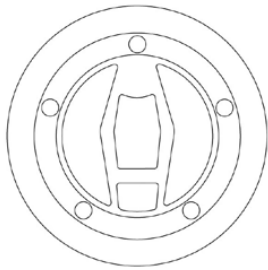

9049

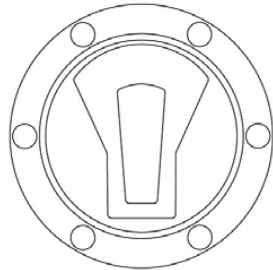

9051

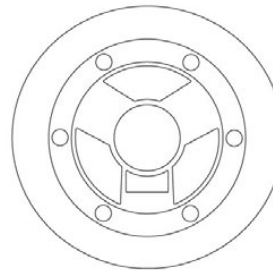

9053

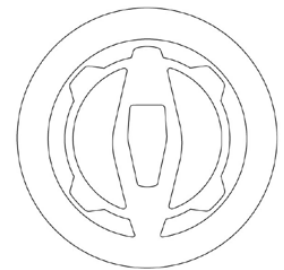

9362

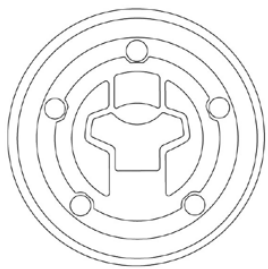

9429



9447

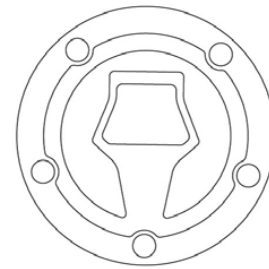

9609

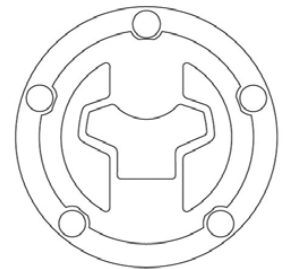

9965

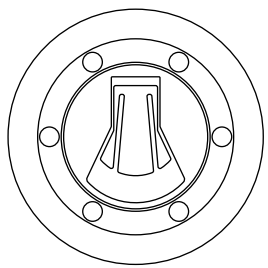

20614

**IMPORTANT:** We recommend verify the design of the cap with the above diagrams when ordering.

# ADHESIVE X-TREME YOKE & TANK PADS



\* Check availability for motorcycle models at [www.puig.tv](http://www.puig.tv) typing in the searching window:

**XTREME**



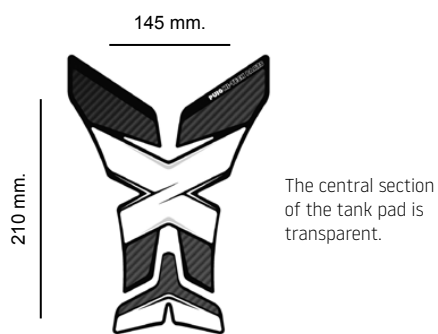

## TANK PAD

MODEL	REF.	C
UNIVERSAL	7597C	(*)



## PLUG DEPOSIT PROTECTOR

MODEL	REF.	C
SPECIFIC MODELS (#)	CHECK WEB	(*)

(#) Drawings of all fuel cap protectors available see page 288.



## YOKE PROTECTOR

MODEL	REF.	C
SPECIFIC MODELS	CHECK WEB	(*)



# FUEL CAP COVER X-TREME

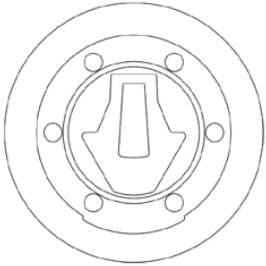

3697

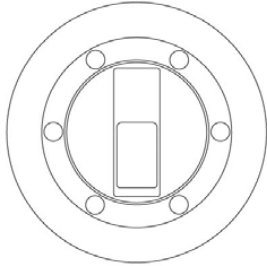

8375

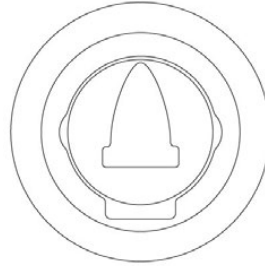

8376

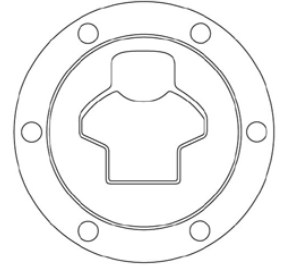

8382

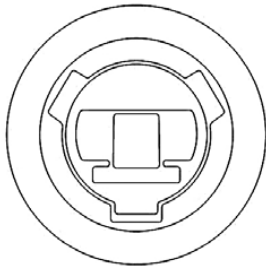

8383

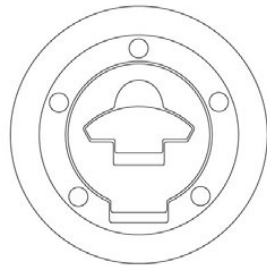

8385

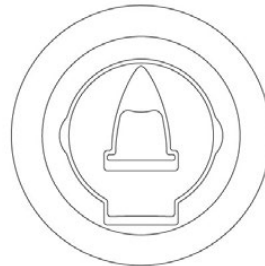

8386



8390

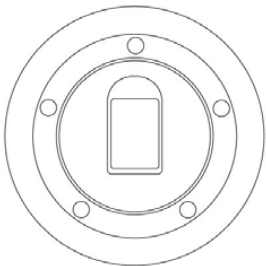

8401

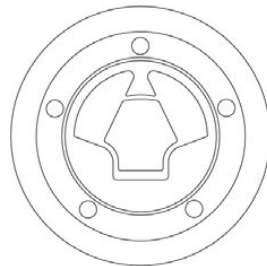

8402

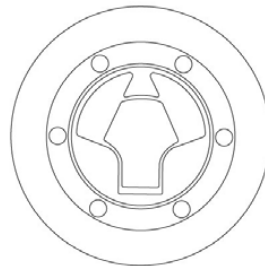

8394

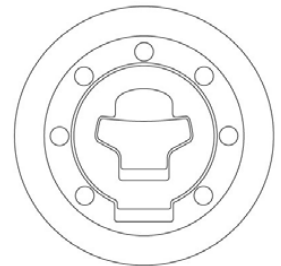

8409

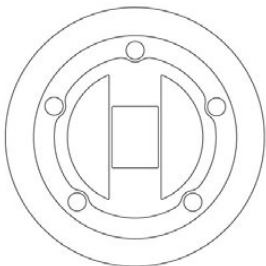

8410

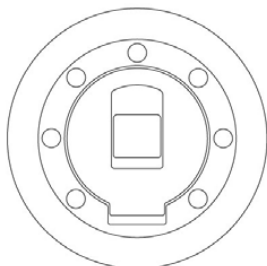

8415

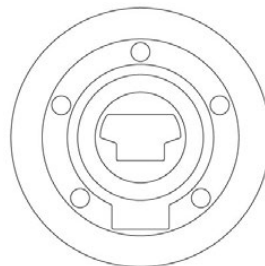

8416

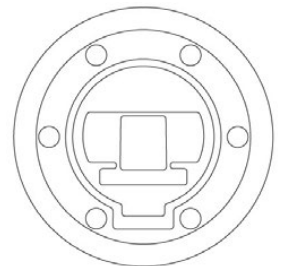

8379

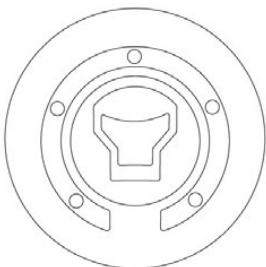

8391



8414

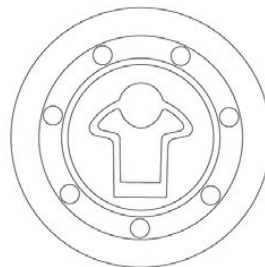

8405

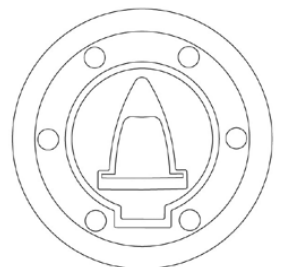

8175

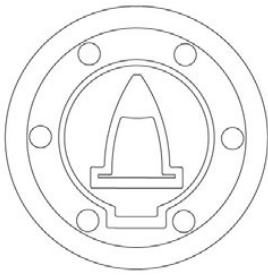

8384

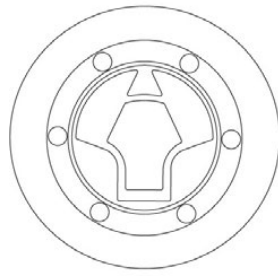

8399

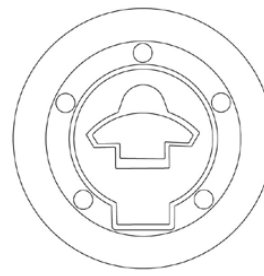

8413

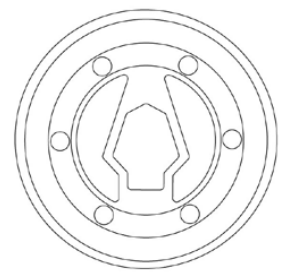

9057

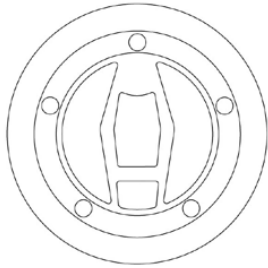

9065



9067

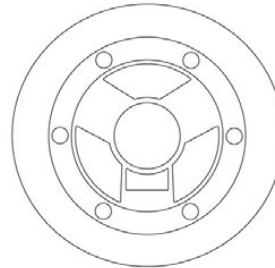

9069



9363

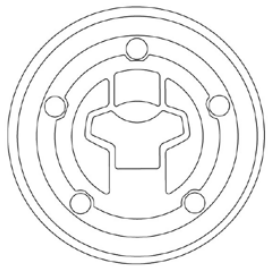

9430



9448

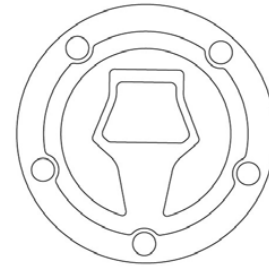

9610



9966

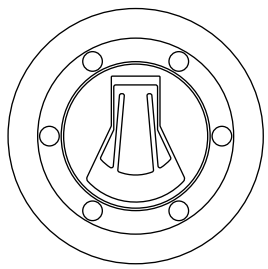

20615

**IMPORTANT:** We recommend verify the design of the cap with the above diagrams when ordering.

# ADHESIVE TANK PADS SET



\* Check availability for motorcycle models at [www.puig.tv](http://www.puig.tv) typing in the searching window:

**SPECIFIC PAD**



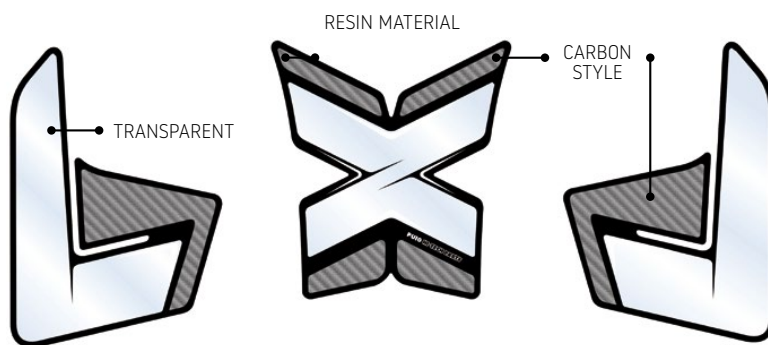

### FORM DESIGNED SPECIFICALLY FOR EACH MODEL MOTORCYCLE

The kit consists of three elements: the frontal protection and the two lateral ones that improve grip in turns.



REF. 3715C



REF. 3718C



REF. 3721C



REF. 8433C



REF. 8434C



REF. 8435C



REF. 8436C

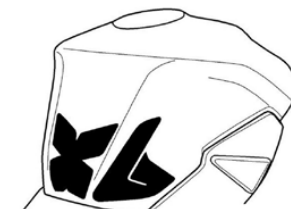

REF. 8437C



REF. 8438C

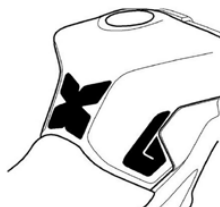

REF. 8439C



REF. 9130C

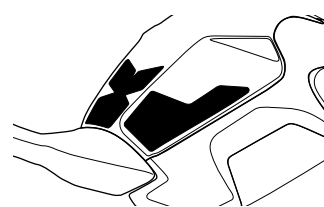

REF. 9294C

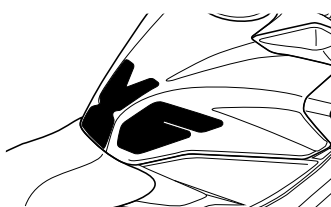

REF. 9295C

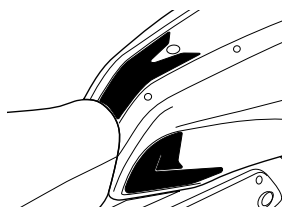

REF. 9300C

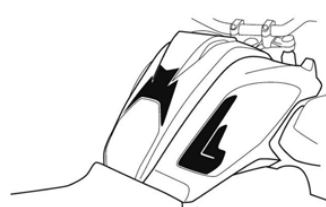

REF. 9463C



# TANK SIDE PROTECTORS ANTI-SLIP



\* Check availability for motorcycle models at [www.puig.tv](http://www.puig.tv) typing in the searching window:

**SIDE PROTECTOR**



- N Black
- W Clear



REF. 20073N



REF. 20600W



REF. 20093N



EASY MOUNTING PROCESS



ANTI-SCRATCH



ANTI-SCRATCH

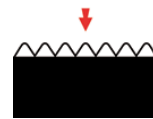

SOFT RUBBER FEEL



# TANK PADS



\* Check availability for motorcycle models at [www.puig.tv](http://www.puig.tv) typing in the searching window:

**CHALLENGE**

**NEW!**



## CHALLENGE

MODEL	REF.	ACNRTVW
CHALLENGE	21752	(*)

A Blue

N Black

T Orange

C Carbon look

R Red

V Green

W Clear

(\*) Check price with your distributor.





\* Check availability for motorcycle models at [www.puig.tv](http://www.puig.tv) typing in the searching window.

**DREI**



## DREI

MODEL	REF.	C W
DREI CARBON LOOK	3075C	(*)
DREI CLEAR	3075W	(*)

 C Carbon look

 W Clear

(\*) Check price with your distributor.



# TANK PADS



\* Check availability for motorcycle models at [www.puig.tv](http://www.puig.tv) typing in the searching window:

**PERFORMANCE**

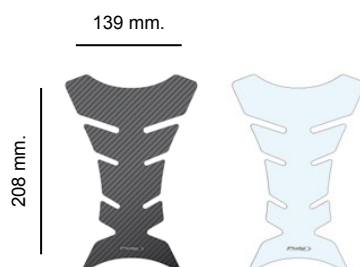

## PERFORMANCE

MODEL	REF.	C P U W
PERFORMANCE CARBON LOOK	4051C	(*)
PERFORMANCE CLEAR	4051W	(*)
PERFORMANCE SILVER	4051P	(*)
PERFORMANCE GREY	4051U	(*)

 **C** Carbon look

 **U** Grey

 **P** Silver

 **W** Clear

(\*) Check price with your distributor.



\* Check availability for motorcycle models at [www.puig.tv](http://www.puig.tv) typing in the searching window:

**PERFORMANCE 2**

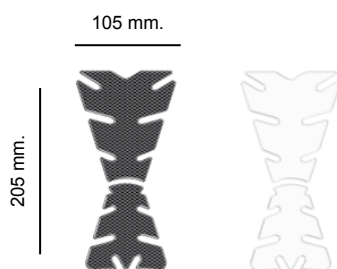

## PERFORMANCE 2

MODEL	REF.	C W
PERFORMANCE 2 CARBON LOOK	5876C	(*)
PERFORMANCE 2 CLEAR	5876W	(*)

 C Carbon look

 W Clear

(\*) Check price with your distributor.

# TANK PADS



\* Check availability for motorcycle models at [www.puig.tv](http://www.puig.tv) typing in the searching window:

**TIRE**



\* Check availability for motorcycle models at [www.puig.tv](http://www.puig.tv) typing in the searching window:

**LEATHER**

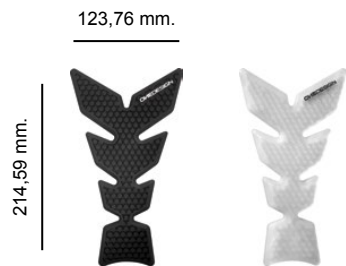

**EASY MOUNTING PROCESS**



**ANTI-SCRATCH**



**ANTI-SCRATCH**



**SOFT RUBBER FEEL**



**SOFT FEEL**

## TIRE

MODEL	REF.	N W
TIRE BLACK	9939N	(*)
TIRE CLEAR	9939W	(*)

## LEATHER

MODEL	REF.	C F N U
LEATHER GREY	9304U	(*)
LEATHER BROWN	9304F	(*)
LEATHER BLACK	9304N	(*)
LEATHER CARBON LOOK	9304C	(*)

C Carbon look

N Black

F Brown

U Grey

W Clear

(\*) Check price with your distributor.

# NEW!



\* Check availability for motorcycle models at [www.puig.tv](http://www.puig.tv) typing in the searching window.

**SOFT**



\* Check availability for motorcycle models at [www.puig.tv](http://www.puig.tv) typing in the searching window.

**GRASP**

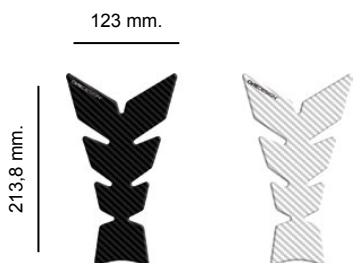
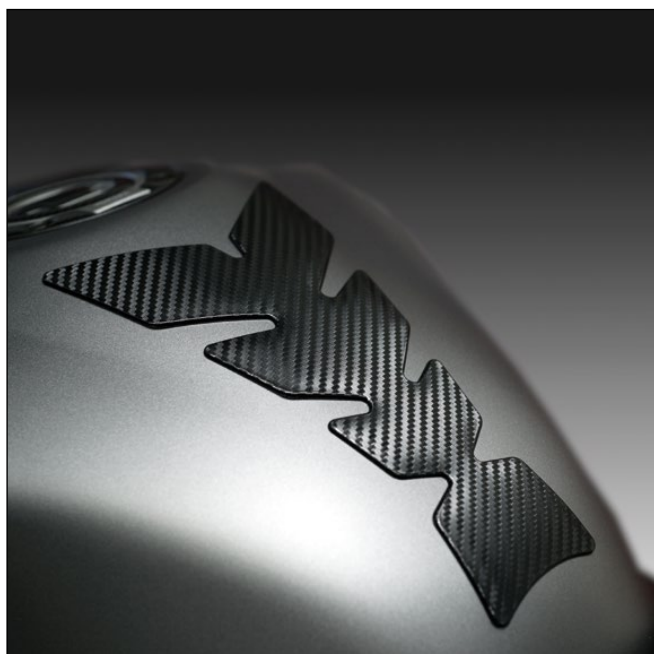

SOFT FEEL

**ONEDESIGN**  
POWERSPORT PROTECTION

**HDF® TECHNOLOGY**

## SOFT

MODEL	REF.	B C
SOFT CARBON LOOK	8432C	(*)
SOFT BLANCO	8432B	(*)

## GRASP

MODEL	REF.	A R T V U
GRASP BLUE	21834A	(*)
GRASP RED	21834R	(*)
GRASP ORANGE	21834T	(*)
GRASP GREEN	21834V	(*)
GRASP GREY	21834U	(*)

■ A Blue  
  B White

  C Carbon look  
■ R Red

■ T Orange  
■ V Green

  U Grey

(\*) Check price with your distributor.



# WINGS TANK PADS



\* Check availability for motorcycle models at [www.puig.tv](http://www.puig.tv) typing in the searching window:

**WINGS**



MODEL	REF.	ANPRV
1 BMW	4718N	(*)
2 DUCATI	4719R	(*)
3 HONDA	4785P	(*)
4 HONDA	4785R	(*)
5 CBR	4784A	(*)
6 CBR	4784P	(*)
7 CBR	4784R	(*)
8 KAWASAKI	4720N	(*)
9 KAWASAKI	4720V	(*)
10 NINJA	4721V	(*)
11 NINJA	4721R	(*)
12 SUZUKI	4724A	(*)
13 YAMAHA	4722A	(*)
14 YAMAHA	4722R	(*)
15 YZF	4723A	(*)
16 YZF	4723R	(*)
17 YZF	4723P	(*)



- A Blue
- N Black
- P Silver
- R Red
- V Green

(\*) Check price with your distributor.

# SPIRIT TANK PADS



\* Check availability for motorcycle models at [www.puig.tv](http://www.puig.tv) typing in the searching window:

**SPIRIT**

## DIMENSIONS

128 x 213 mm.



REF. 4219N



REF. 4220N



REF. 4221N



REF. 4222N



REF. 4223N



REF. 4224N



REF. 4225N



REF. 4226N



REF. 4227N



REF. 4228N



REF. 4327N



REF. 4328N



REF. 4329N



REF. 4341N



REF. 4342N



REF. 4479N



REF. 4725N



REF. 4726N





REF. 4728N



REF. 5111N



REF. 5184N



REF. 5185N



REF. 7484N



REF. 9142N



REF. 9306N



REF. 9307N



REF. 9308N



REF. 0480N



REF. 0481N



REF. 20482N



REF. 20483N



REF. 20484N



REF. 20485N



REF. 21416N



REF. 21417N



REF. 21418N



REF. 21419N



REF. 21420N



REF. 21421N



REF. 21422N





REF. 21423N



REF. 21424N



REF. 21425N

 N Black  
 P Silver



# TANK PADS



\* Check availability for motorcycle models at [www.puig.tv](http://www.puig.tv) typing in the searching window:

**FUTURE**



\* Check availability for motorcycle models at [www.puig.tv](http://www.puig.tv) typing in the searching window:

**VIOLENT**

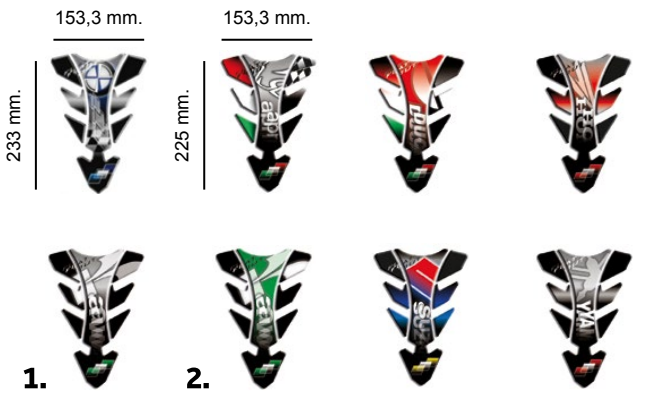

## FUTURE

MODEL	REF.	A N R P V
APRILIA	5631N	(*)
BMW	6460P	(*)
DUCATI	5633R	(*)
HONDA	5634R	(*)
KAWASAKI (1)	5630P	(*)
KAWASAKI (2)	5630V	(*)
SUZUKI	5632A	(*)
YAMAHA	5635P	(*)

## VIOLENT

MODEL	REF.	A C N R V W
VIOLENT BLUE	5519A	(*)
VIOLENT CARBON LOOK	5519C	(*)
VIOLENT BLACK	5519N	(*)
VIOLENT RED	5519R	(*)
VIOLENT GREEN	5519V	(*)
VIOLENT CLEAR	5519W	(*)

- A Blue
- N Black
- R Red
- C Carbon look
- P Silver
- V Green

- W Clear

(\*) Check price with your distributor.



\* Check availability for motorcycle models at [www.puig.tv](http://www.puig.tv) typing in the searching window:

**SPIRIT II**



\* Check availability for motorcycle models at [www.puig.tv](http://www.puig.tv) typing in the searching window:

**ONE**



128 mm.

213 mm.



123 mm.

213,8 mm.



SOFT FEEL

**SPIRIT II**

MODEL	REF.	A T V
SPIRIT II BLUE	9140A	(*)
SPIRIT II ORANGE	9140T	(*)
SPIRIT II GREEN	9140V	(*)

**ONE**

MODEL	REF.	A R V
ONE BLUE	9141A	(*)
ONE RED	9141R	(*)
ONE GREEN	9141V	(*)

- A Blue
- T Orange
- R Red
- V Green

(\*) Check price with your distributor.

# TANK PADS



\* Check availability for motorcycle models at [www.puig.tv](http://www.puig.tv) typing in the searching window:

**SCARY**



\* Check availability for motorcycle models at [www.puig.tv](http://www.puig.tv) typing in the searching window:

**GIRL**



134,2 mm.

222,9 mm.



134,2 mm.

222,9 mm.



## SCARY

MODEL	REF.	N
SCARY	21433N	(*)

## GIRL

MODEL	REF.	N
GIRL	21434N	(*)





\* Check availability for motorcycle models at [www.puig.tv](http://www.puig.tv) typing in the searching window:

**SKULL POKER**



\* Check availability for motorcycle models at [www.puig.tv](http://www.puig.tv) typing in the searching window:

**CASINO**



134,2 mm.



134,2 mm.



## SKULL & POKER

MODEL	REF.	N
SKULL & POKER	21435N	(*)

## CASINO

MODEL	REF.	N
CASINO	21436N	(*)

 N Black

(\*) Check price with your distributor.



# TANK PADS



\* Check availability for motorcycle models at [www.puig.tv](http://www.puig.tv) typing in the searching window:

**MOON**



\* Check availability for motorcycle models at [www.puig.tv](http://www.puig.tv) typing in the searching window:

**SCREAM**



134,2 mm.



1.

2.

3.

123 mm.



213,8 mm.

## MOON

MODEL	REF.	P R T
MOON RED (1)	9139R	(*)
MOON SILVER (2)	9139P	(*)
MOON ORANGE (3)	9139T	(*)

## SCREAM

MODEL	REF.	N
SCREAM BLACK	9602N	(*)

N Black  
 P Silver

R Red  
 T Orange

(\*) Check price with your distributor.



\* Check availability for motorcycle models at [www.puig.tv](http://www.puig.tv) typing in the searching window.

**JOKER**



\* Check availability for motorcycle models at [www.puig.tv](http://www.puig.tv) typing in the searching window.

**CLOWN**



144,4 mm.

221 mm.



128 mm.

213 mm.



**JOKER**

MODEL	REF.	A U V
JOKER GREY	6496U	(*)
JOKER GREEN	6496V	(*)
JOKER BLUE	6496A	(*)

**CLOWN**

MODEL	REF.	A U V
CLOWN GREY	9305U	(*)
CLOWN GREEN	9305V	(*)
CLOWN BLUE	9305A	(*)

■ A Blue  
■ U Grey

■ V Green

(\*) Check price with your distributor.

# TANK PADS



134,2 mm.

222,9 mm.



## SKULL PARTY

MODEL	REF.	N
SKULL PARTY	20593N	(*)



\* Check availability for motorcycle models at [www.puig.tv](http://www.puig.tv) typing in the searching window:

**SKULL PARTY**



134,2 mm.

222,9 mm.



## SKULL PARTY BLACK & WHITE

MODEL	REF.	N
SKULL PARTY BLACK & WHITE	20594N	(*)



\* Check availability for motorcycle models at [www.puig.tv](http://www.puig.tv) typing in the searching window:

**SKULL PARTY**



134,2 mm.

222,9 mm.



## ROCK & ROLL

MODEL	REF.	N
ROCK & ROLL	20595N	(*)



\* Check availability for motorcycle models at [www.puig.tv](http://www.puig.tv) typing in the searching window:

**ROCK ROLL**





134,2 mm.

222,9 mm.



## BIKE

MODEL	REF.	N
BIKE BLACK	20592N	(*)



\* Check availability for motorcycle models at [www.puig.tv](http://www.puig.tv) typing in the searching window:

**BIKE**



116,7 mm.

180 mm.



## F-YOU

MODEL	REF.	N
F-YOU BLACK	20596N	(*)



\* Check availability for motorcycle models at [www.puig.tv](http://www.puig.tv) typing in the searching window:

**F-YOU**



134,2 mm.

222,9 mm.



## MUGELLO

MODEL	REF.	N
MUGELLO BLACK	20597N	(*)



\* Check availability for motorcycle models at [www.puig.tv](http://www.puig.tv) typing in the searching window:

**MUGELLO**



# TANK PADS



■ A Blue  
■ R Red

■ V Green

156,5 mm.

100 mm.



## SKULL

MODEL	REF.	A R V
SKULL RED	3673R	(*)
SKULL GREEN	3673V	(*)
SKULL BLUE	3673A	(*)



\* Check availability for motorcycle models at [www.puig.tv](http://www.puig.tv) typing in the searching window:

**SKULL**

156,5 mm.

100 mm.



## SKULL I

MODEL	REF.	R
SKULL I	3674R	(*)



\* Check availability for motorcycle models at [www.puig.tv](http://www.puig.tv) typing in the searching window:

**SKULL I**

134 mm.

230 mm.

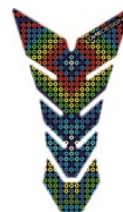

## COLOURY

MODEL	REF.	R
COLOURY	3675R	(*)



\* Check availability for motorcycle models at [www.puig.tv](http://www.puig.tv) typing in the searching window:

**COLOURY**

(\*) Check price with your distributor.



\* Check availability for motorcycle models at [www.puig.tv](http://www.puig.tv) typing in the searching window:

**MINI**



\* Check availability for motorcycle models at [www.puig.tv](http://www.puig.tv) typing in the searching window:

**ARROW**

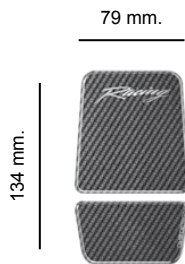

**MINI**

MODEL	REF.	C
MINI CARBON LOOK	2560C	(*)

**ARROW**

MODEL	REF.	C
ARROW CARBON LOOK	2774C	(*)

# TANK PADS



\* Check availability for motorcycle models at [www.puig.tv](http://www.puig.tv) typing in the searching window:

**WAY**



\* Check availability for motorcycle models at [www.puig.tv](http://www.puig.tv) typing in the searching window:

**SUN**

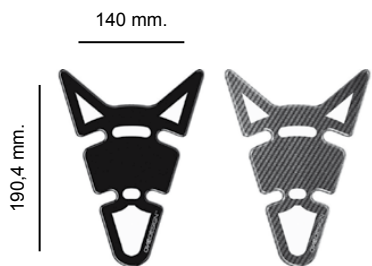

## WAY

MODEL	REF.	C N
WAY BLACK	4478N	(*)
WAY CARBON LOOK	4478C	(*)

## SUN

MODEL	REF.	C W
SUN CARBON LOOK	4512C	(*)
SUN CLEAR	4512W	(*)

 C Carbon look

 N Black

 W Clear

(\*) Check price with your distributor.



# SHEETS



\* Check availability for motorcycle models at [www.puig.tv](http://www.puig.tv) typing in the searching window:

**SHEET**



\* Check availability for motorcycle models at [www.puig.tv](http://www.puig.tv) typing in the searching window:

**BUMPS**



## BUMPS-SHEET

MODEL	REF.	C W
1 SHEET COLOUR CARBON LOOK 250 x 350 mm.	4557C	(*)
1 SHEET COLOUR CLEAR 250 x 350 mm.	4558W	(*)

**NOTE:** gripping adhesive sheet, developed to protect certain parts from being scratched, and to improve.

The grip of the rider.

**Sheet size:** 250 x 350 mm.

## FLAT SHEET

MODEL	REF.	C
1 SHEET COLOUR CARBON	4556C	(*)

**Sheet dimensions:** 320 x 460 mm.

## GRIPPING PADS

MODEL	REF.	N
JUEGO DE BUMPS 170 x 93,5 mm.	9310N	(*)

 C Carbon look

 N Black

 W Clear

(\*) Check price with your distributor.



# SCRATCH PADS PROTECTOR



\* Check availability for motorcycle models at [www.puig.tv](http://www.puig.tv) typing in the searching window:

**SCRATCH SAVER**



■ N Black

**KYMCO AK550**  
TANKPAD SCOOTER SCRATCH SAVER

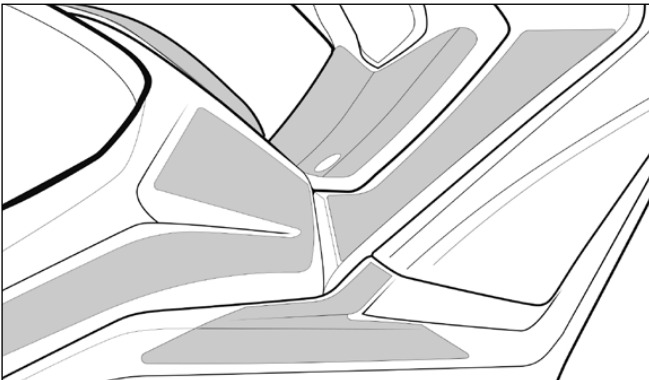

**SPECIFIC DESIGN FOR EACH MODEL OF MAXISCOOTER**

Protects from scratches of getting on/off the bike, as well as embellishes the plastic without altering the graphics of the Maxiscooter.

# 4

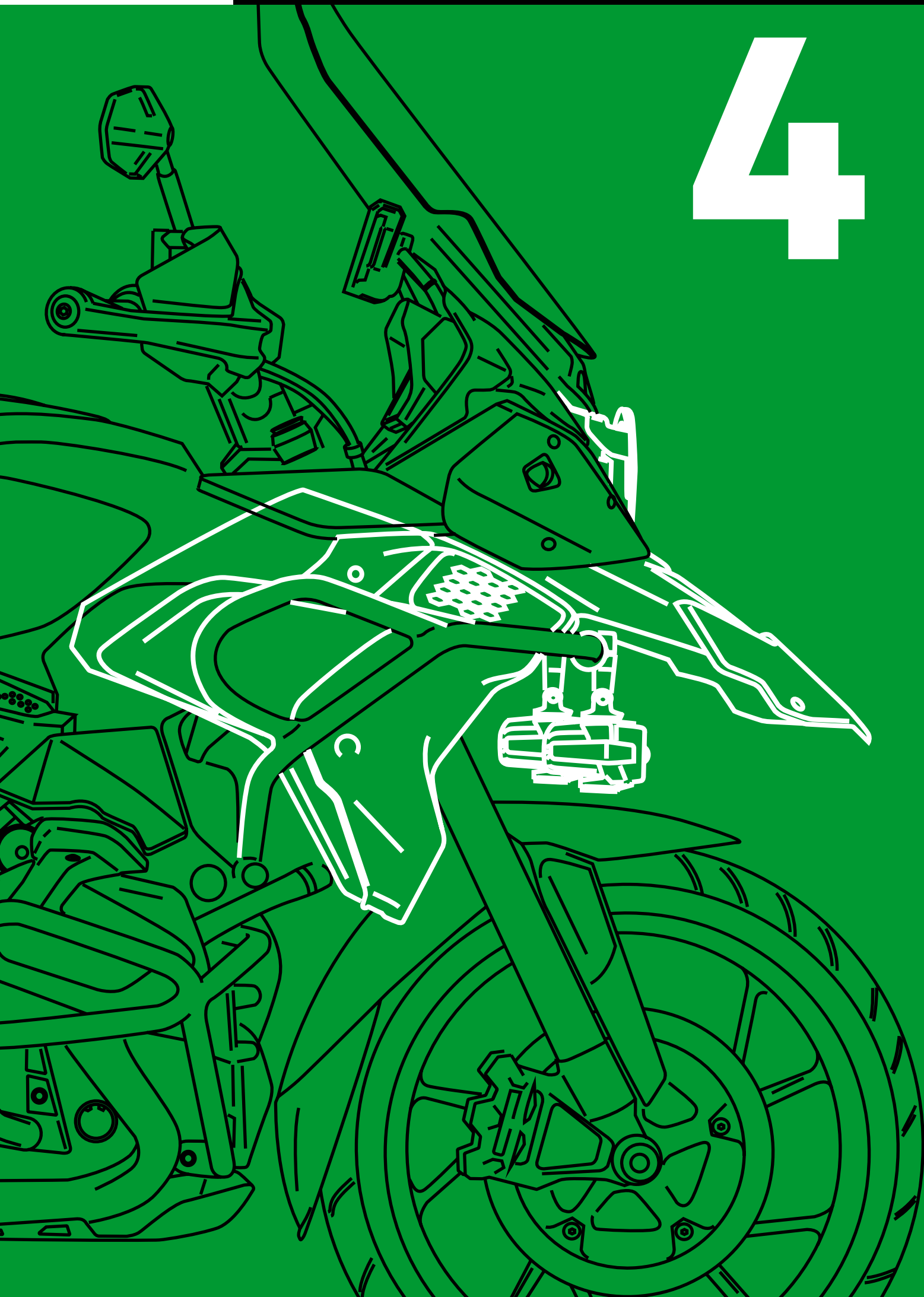

# MIDDLE FRONT AREA

ADHERE HEADLIGHT PROTECTOR	<b>328</b>
BEAK EXTENDER	<b>320</b>
CONNECTORS LEADS	<b>365</b>
HEADLIGHT PROTECTOR	<b>326</b>
HI-BEAM 2.0 AUXILIARY LIGHTS	<b>338</b>
HI-BEAM 3.0 AUXILIARY LIGHTS	<b>336</b>
HI-BEAM AUXILIARY LIGHTS	<b>340</b>
LOWER DEFLECTORS	<b>324</b>
LUMEN LED HEADLIGHT	<b>330</b>
LUMEN R LED HEADLIGHT	<b>332</b>
LUMEN Z LED HEADLIGHT	<b>334</b>
RADIATOR SIDE PANELS	<b>322</b>
RESISTOR SET FOR LEDS TURN SIGNALS AND FLASHER RELAYS	<b>364</b>
SEQUENTIAL TURN SIGNALS	<b>344</b>
TURN SIGNAL COVERS	<b>342</b>
TURN SIGNALS POWER LED / PUTT	<b>352</b>
TURN SIGNALS BUOY / BUOY II	<b>349</b>
TURN SIGNALS CIGAR / AX	<b>358</b>
TURN SIGNALS CURVE	<b>355</b>
TURN SIGNALS DART / TAB	<b>346</b>
TURN SIGNALS EYE / TIP	<b>360</b>
TURN SIGNALS INTEGRADOS	<b>369</b>
TURN SIGNALS LIGHT / STICK	<b>354</b>
TURN SIGNALS MASA	<b>363</b>
TURN SIGNALS MINI	<b>362</b>
TURN SIGNALS OPEN / RUBI	<b>351</b>
TURN SIGNALS PEAK	<b>357</b>
TURN SIGNALS PIRAMIDE / CHIP	<b>347</b>
TURN SIGNALS SNAKE / FLECHA	<b>353</b>
TURN SIGNALS SPARKLY / HOUSE	<b>348</b>
TURN SIGNALS SPEED / BALA	<b>359</b>
TURN SIGNALS STAR	<b>361</b>
TURN SIGNALS TINY / MINIMAL	<b>350</b>
TURN SIGNALS ZAFIRO / LANZA	<b>356</b>



# BEAK EXTENDER



\* Check availability for motorcycle models at [www.puig.tv](http://www.puig.tv) typing in the searching window:

**BEAK**



Thanks to its manufacture in ABS (matt black), a plastic material highly resistant to impacts, this beak extender will perfectly protect the front of the motorcycle.

It is a piece that is easy to assemble, since it does not require drilling holes in the front fender.

## ABS



REF. 3483J



REF. 3837J

This beak-shaped extension protects against splashes and the impact of small objects, such as stones, insects... that we can find both on the road and on dirt roads, while providing an aerodynamic improvement, giving an extra load on the front axle providing better stability on fast roads. Therefore, it is ideal for trail motorcycles that can combine riding both on dirt and on asphalt.

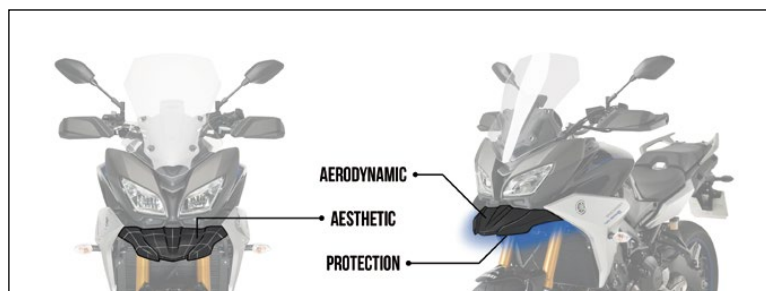



# RADIATOR SIDE PANELS



\* Check availability for motorcycle models at [www.puig.tv](http://www.puig.tv) typing in the searching window.

**RADIATOR COVER**



Give a sporty touch to your motorcycle and protect yourself from possible inclement weather with the Puig radiator covers. Made of ABS, a highly impact resistant material, it protects one of the most sensitive areas of your vehicle.

 **C** Carbon look

 **J** Matt black

ABS



REF. 8564C



REF. 9371J

Radiator covers are available in matt black and carbon look to perfectly match the aesthetic lines of your bike.  
These are easy to assemble pieces that are accompanied by instructions, simple and visual, for proper placement.

They cover the radiator's side edges and provide a continuous air flow around the rider's legs.

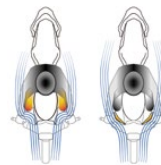
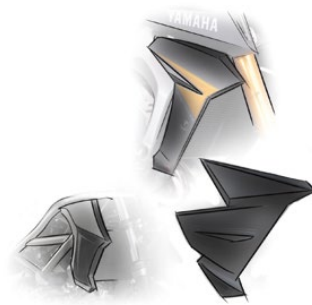
**PROTECTION**

Protects the rider from inclement weather.



# LOWER DEFLECTORS



\* Check availability for motorcycle models at [www.puig.tv](http://www.puig.tv) typing in the searching window:

**LOWER DEFLECTOR**



PMMA  
ACRYLIC

C Carbon look  
 F Dark Smoke

H Smoke  
 W Clear



REF. 9848H

They adapt perfectly to the lines of the motorcycle thanks to their design and the quality of their finishes, allowing the airflow to be diverted away from the legs and improving riding comfort.

# HEADLIGHT PROTECTOR



\* Check availability for motorcycle models at [www.puig.tv](http://www.puig.tv) typing in the searching window:

**HEADLIGHT PROTECTOR**





REF. 3733W

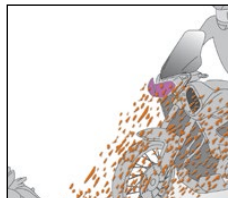

REF. 20413W

**PROTECTION**

Avoid impact of objects or insects on the headlight.

Protection made of polycarbonate that will perfectly protect our headlight. The steel supports are painted with EPOXY paint, in black, to preserve the original aesthetics of the motorcycle as much as possible.

Manufactured and designed in Barcelona with the highest technologies and materials for a high quality accessory that enhance the performance of your motorcycle and protects it from inclement weather and possible impacts that could scratch or break your front light.



# ADHERE HEADLIGHT PROTECTOR



\* Check availability for motorcycle models at [www.puig.tv](http://www.puig.tv) typing in the searching window:

**ADHERE**



W Clear



**STEP 1**

Clean the headlight by splashing a little water and soaking it well.

**STEP 2**

Position the headlight protector and center it.

**STEP 3**

Press from the center to the sides.

Effective protection of the headlight against the impact of small objects, scratches, dirt, insects and premature wear due to exposure to UV rays. It is made of a high-end 200 micron thick, totally clear polyurethane sheet.

Therefore, it remains unnoticed when installed on the motorcycle without affecting the aesthetics and guaranteeing optimal lighting. It can be installed and uninstalled easily and quickly, without leaving any type of mark, it does not scratch or come off when washed or inclement weather.



Durable and waterproof self-adhesive vinyl



Adhesive



Easy to apply so there are no air bubbles



Easy to clean



Anti-scratch treatment



UV resistant

**Material:** clear adhesive PVC, shaped and designed specifically for each motorcycle model.



# LUMEN LED HEADLIGHT



\* Check availability for motorcycle models at [www.puig.tv](http://www.puig.tv) typing in the searching window:

**LUMEN**



## TECHNICAL CHARACTERISTICS:

**High Beam:** Watt: 11W / Lumen: 900LM / LUX: 32LUX / Candela: 20000

**Low Beam:** Watt: 9W / Lumen: 800LM / LUX: 15LUX / Candela: 9300

**Light Position:** Watt: 4W

**Material:** PC Lenses / Aluminum housing

● N Black

**HOMOLOGATED**

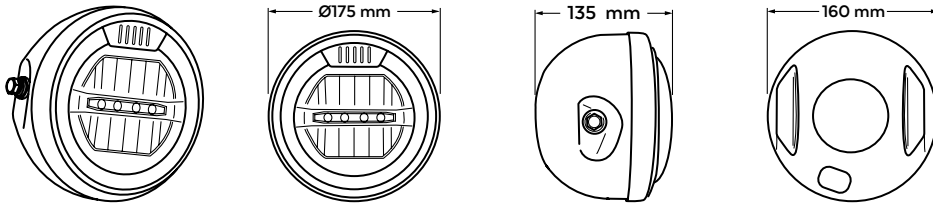
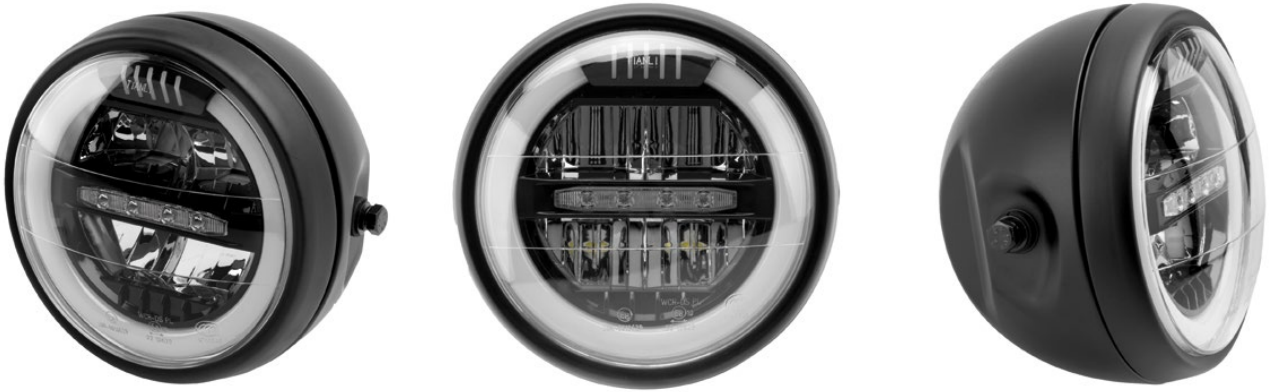

MODEL	REF.	N
LED LIGHTS HOMOLOGATED 175 x 160,4 mm. 11W HIGH / 9W LOW / 4W POS COLOR BLACK	1944N	(*)

(\*) Check price with your distributor.

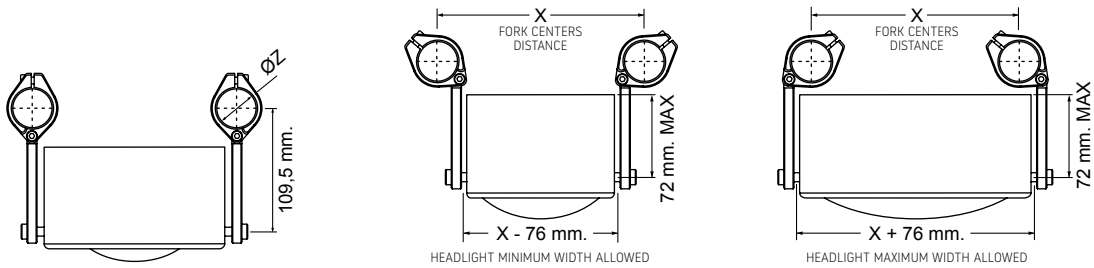

**CLAMP SET**

MODEL	REF.	N
CLAMP SET OF DIAMETER 35-37 cm. + SUPPORT FOR HEADLIGHTS	20876N	(*)
CLAMP SET OF DIAMETER 38-41 cm. + SUPPORT FOR HEADLIGHTS	20877N	(*)
CLAMP SET OF DIAMETER 42-43 cm. + SUPPORT FOR HEADLIGHTS	20878N	(*)



# LUMEN R LED HEADLIGHT



\* Check availability for motorcycle models at [www.puig.tv](http://www.puig.tv) typing in the searching window:

**LUMEN R**



## TECHNICAL CHARACTERISTICS:

**Long Beam:** 12V, 45W, 3500LM

**Low Beam:** 12V, 30W, 2000LM

**Light Position:** 12V, 3.5W, 250LM

**Material:** PC Lenses / Aluminum housing



**N Black**

**HOMOLOGATED**

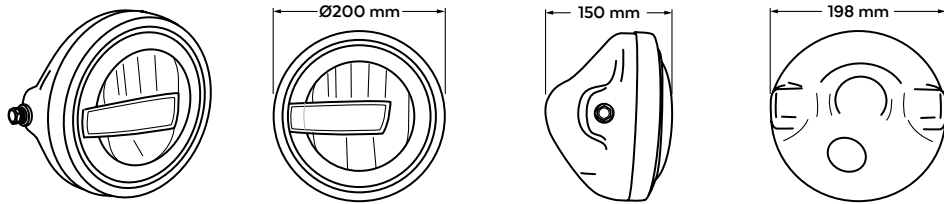

MODEL	REF.	N
LED LIGHTS HOMOLOGATED 175 x 160,4 mm. 11W HIGH / 9W LOW / 4W POS COLOR BLACK	20818N	(*)

(\*) Check price with your distributor.



REF. 20876N

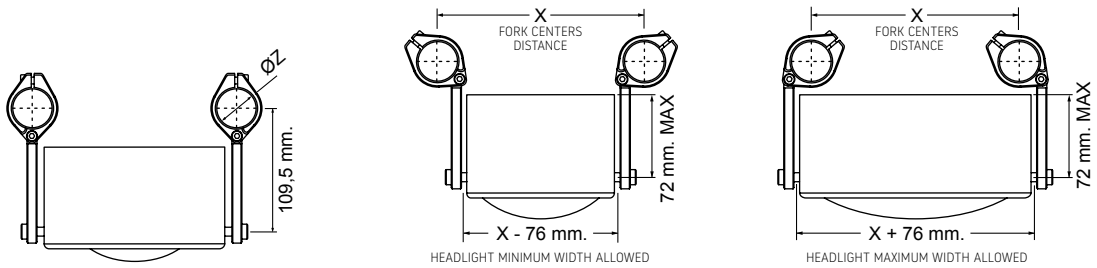

**CLAMP SET**

MODEL	REF.	N
CLAMP SET OF DIAMETER 35-37 cm. + SUPPORT FOR HEADLIGHTS	20876N	(*)
CLAMP SET OF DIAMETER 38-41 cm. + SUPPORT FOR HEADLIGHTS	20877N	(*)
CLAMP SET OF DIAMETER 42-43 cm. + SUPPORT FOR HEADLIGHTS	20878N	(*)

# LUMEN Z LED HEADLIGHT



\* Check availability for motorcycle models at [www.puig.tv](http://www.puig.tv) typing in the searching window:

**LUMEN Z**



## TECHNICAL CHARACTERISTICS:

**Long Beam:** 12V, 45W, 3500LM

**Low Beam:** 12V, 30W, 2000LM

**Light Position:** 12V, 3.5W, 250LM

**Material:** PC Lenses / Aluminum housing



**N Black**



**HOMOLOGATED**

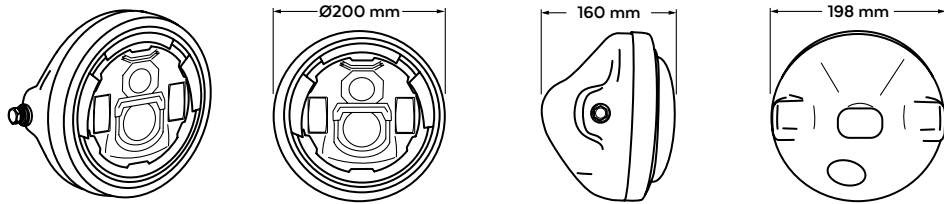

MODEL	REF.	N
LED TECHNOLOGY HEADLAMP HOMOLOGATED BLACK COLOR	21346N	(*)

(\*) Check price with your distributor.



REF. 20876N

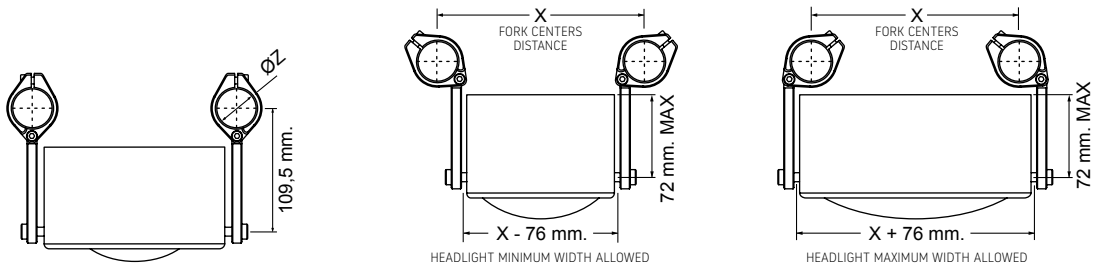

**CLAMP SET**

MODEL	REF.	N
CLAMP SET OF DIAMETER 35-37 cm. + SUPPORT FOR HEADLIGHTS	20876N	(*)
CLAMP SET OF DIAMETER 38-41 cm. + SUPPORT FOR HEADLIGHTS	20877N	(*)
CLAMP SET OF DIAMETER 42-43 cm. + SUPPORT FOR HEADLIGHTS	20878N	(*)



# HI-BEAM 3.0 AUXILIARY LIGHTS



\* Check availability for motorcycle models at [www.puig.tv](http://www.puig.tv) typing in the searching window:

**AUXILIARY LIGHTS**

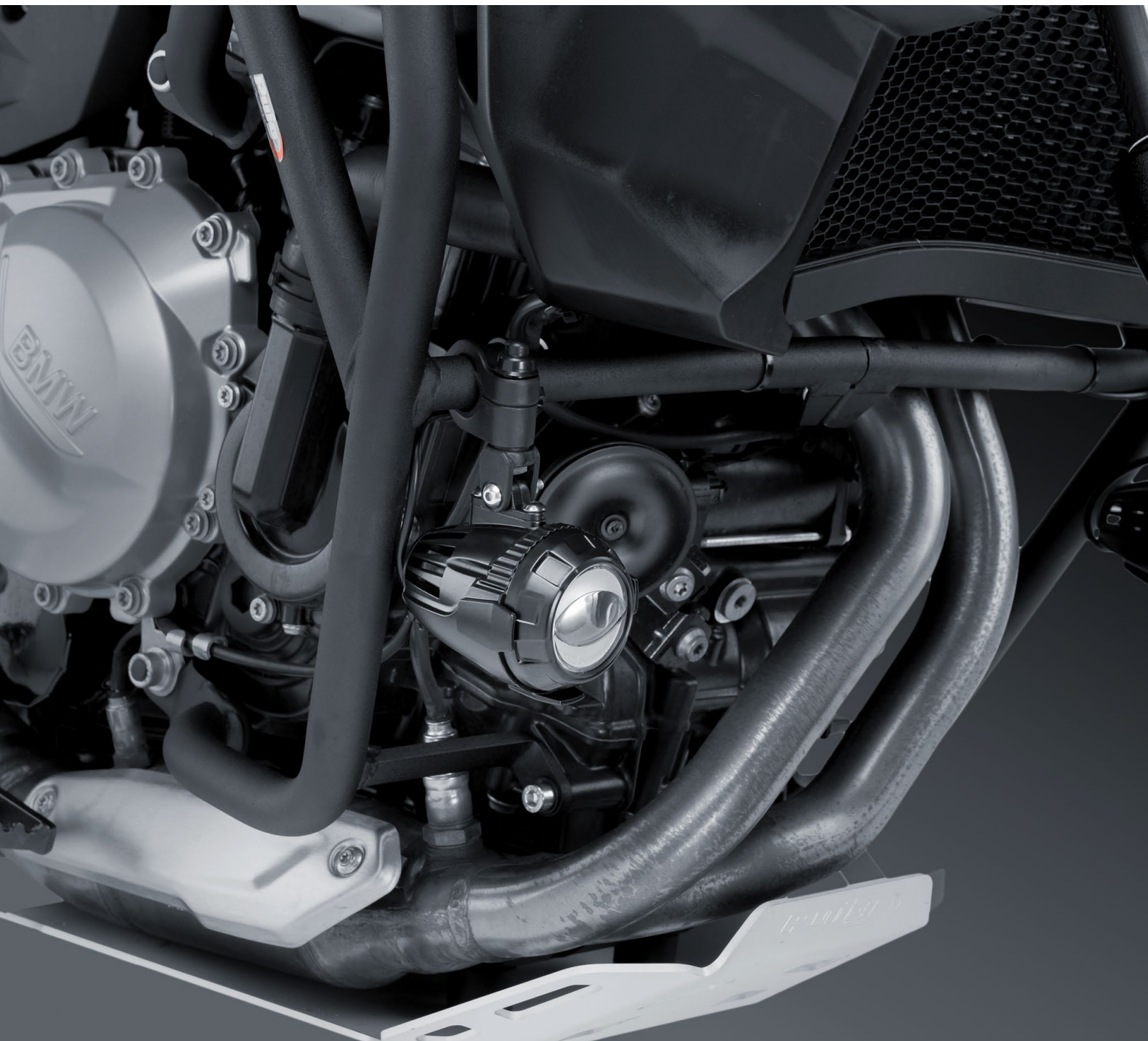

## TECHNICAL CHARACTERISTICS:

**Low consumption:** 60w (30w per light)

**Voltage:** DC 12V

**Lumens:** 2200L M (1100L M/light)

**Material:** PC Lenses / Aluminum housing

■ N Black

**NEW!**

**HOMOLOGATED**



Intermediate in size and performance between the Hi-Beam and Hi-Beam 2.0 auxiliary lights, they have the same regulation as the Beam 2.0 model.

The 3.0 version continues to provide an extra lighting, since it improves our vision in different circumstances such as night riding, fog, rain, snow and twisty sections.

They incorporate LED technology to combine power and low consumption, they can be installed easily and safely on motorcycle fenders and are adaptable for 25 mm. diameter tubes.

Due to their size, they cannot be installed on Puig's R19 frame sliders.

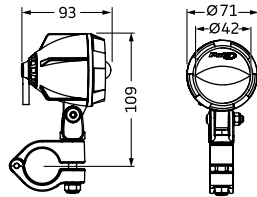
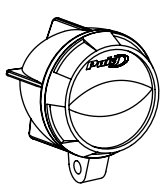

**DIMENSIONS**

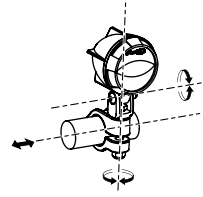

**ADJUSTABLE**



**ADAPTABLE**

Adjustable to 25 mm. diameter tube.

MODEL	REF.	N
<b>UNIVERSAL</b>		
SET AUXILIARY HEADLIGHTS HOMOLOGUE (1)	21786N	(*)
<b>SPARES</b>		
WIRED KIT + SWITCH (2)	3541N	(*)
CLAMP SET 25'5 mm. (3)	21788N	(*)
SWITCH (4)	20438N	(*)
AUXILIARY HEADLIGHT HOMOLOGATED - UNIT (5)	21787N	(*)

(\*) Check price with your distributor.

\* Check that the mounting of the auxiliary lights does not interfere with the frame of the motorcycle



# HI-BEAM 2.0 AUXILIARY LIGHTS



\* Check availability for motorcycle models at [www.puig.tv](http://www.puig.tv) typing in the searching window:

**AUXILIARY LIGHTS**



## TECHNICAL CHARACTERISTICS:

**Low consumption:** 30w (15w per light)

**Voltage:** DC 12V

**Lumens:** 2000L M (1000LM/light)

**Material:** PC Lenses / Aluminum housing



N Black

**HOMOLOGATED**



Universal fog lights and aluminium case painted black.

LED technology with low power consumption, avoiding putting the battery in danger due to excessive consumption.

Supplied with instructions on our engine guards.

Equipped with a fuse and cables to connect directly to your battery and with a water proof switch to be installed on your handlebars.

Aluminum housing designed to promote heat dissipation.

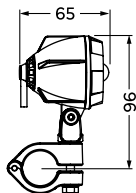
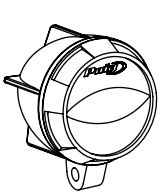

DIMENSIONS

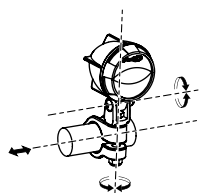

ADJUSTABLE



ADAPTABLE

Adjustable to 25 mm. diameter tube.

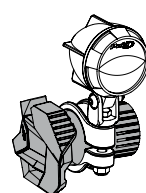

ADAPTABLE

Adjustable to R12/R19 frame sliders\* with clamp Ref. 20756N

MODEL	REF.	N
<b>UNIVERSAL</b>		
SET OF AUXILIARY HEADLIGHTS + CLAMP SET 25,5 mm. HOMOLOGATED (1)	20755N	(*)
CLAMP SET 39 mm. FOR FRAME SLIDERS R19 (2)	20756N	(*)
<b>SPARES</b>		
WIRED KIT + SWITCH (3)	3541N	(*)
CLAMP SET 25'5 mm. (4)	20831N	(*)
CLAMP SET 28 mm. (4)	21540N	(*)
SWITCH (5)	20438N	(*)
AUXILIARY HEADLIGHT HOMOLOGATED - UNIT (6)	21373N	(*)

(\*) Check price with your distributor.

\* Check that the mounting of the auxiliary lights does not interfere with the frame of the motorcycle



# HI-BEAM AUXILIARY LIGHTS



\* Check availability for motorcycle models at [www.puig.tv](http://www.puig.tv) typing in the searching window:

**AUXILIARY LIGHTS**



## TECHNICAL CHARACTERISTICS:

**Low consumption:** 40w (20w per light)

**Voltage:** DC 12-24v

**Lumens:** 4000L M (2000LM/light)

**Material:** PC Lenses / Aluminum housing



**N** Black

**HOMOLOGATED**



Universal fog lights and aluminium case painted black.

LED technology with low power consumption, avoiding putting the battery in danger due to excessive consumption.

Supplied with instructions on our engine guards. Fit engine guards between 23 and 25 mm. diameter.

Equipped with a fuse and cables to connect directly to your battery and with a water proof switch to be installed on your handlebars.

Aluminum housing designed to promote heat dissipation.

Optional metallic grill protections for offroad use.

Sells separately (Ref. 9785N)

**MOUNTING:**

To mount the auxiliary lights on the Puig engine guards use only one of the two spacers that carries the support and the allen screw M6 x 50.

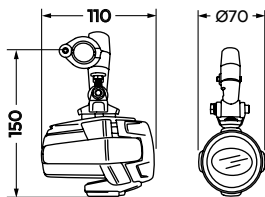
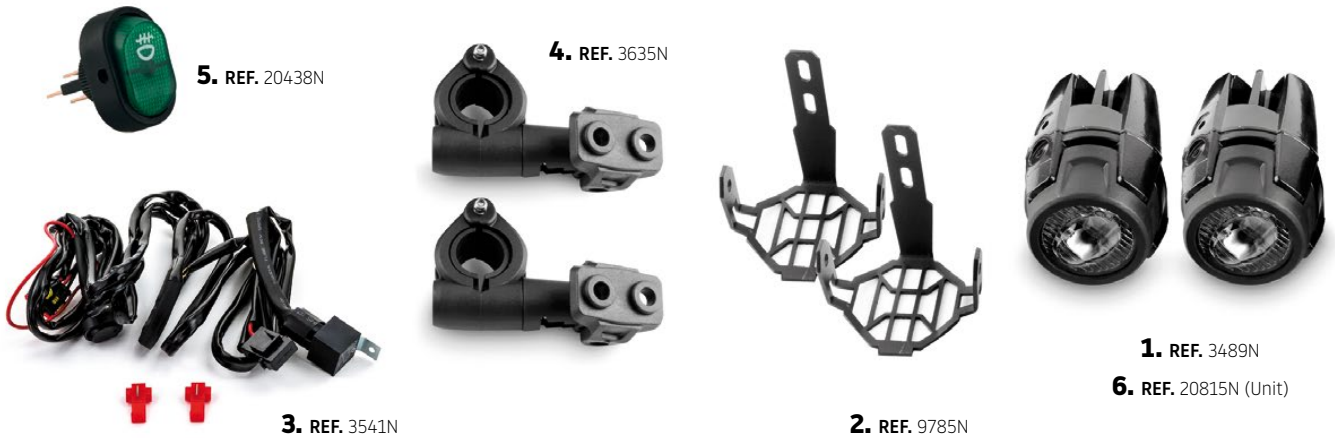

**DIMENSIONS**

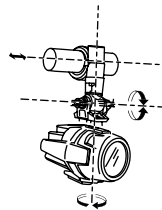

**ADJUSTABLE**



**ADAPTABLE**

Adjustable to 25 mm. diameter tube.

MODEL	REF.	N
<b>UNIVERSAL</b>		
SET AUXILIARY HEADLIGHTS HOMOLOGUE (1)	3489N	(*)
SET PROTECTION GRID (2)	9785N	(*)
<b>SPARES</b>		
WIRED KIT + SWITCH (3)	3541N	(*)
CLAMP + SUPPORT AUXILIARY LIGHTS (4)	3635N	(*)
SWITCH (5)	20438N	(*)
AUXILIARY HEADLIGHT HOMOLOGATED - UNIT (6)	20815N	(*)
AUXILIARY HEADLIGHTS RELAY	21692N	(*)

(\*) Check price with your distributor.

# TURN SIGNAL COVERS



\* Check availability for motorcycle models at [www.puig.tv](http://www.puig.tv) typing in the searching window:

**SUPPORT TURN LIGHT**



By replacing the standard turn signals with universal ones, on certain models there is a space left in the fairing that does not affect the functionality or the rigidity of the fixing but which, when stationary, can condition the aesthetic result of the motorcycle customization work. To resolve this, Puig offers a wide range of references for this cover.



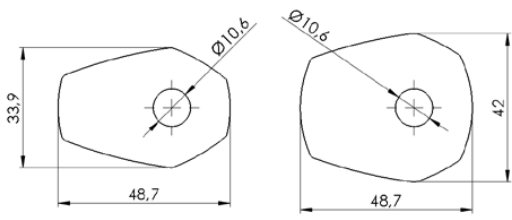

REF. 3958

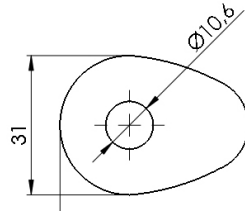

REF. 3956

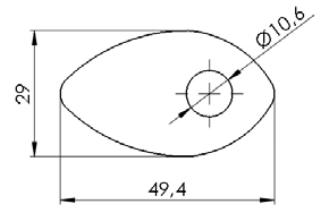

REF. 3957

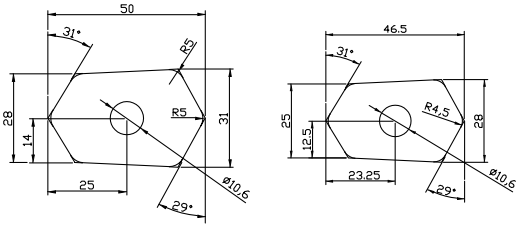

REF. 5329

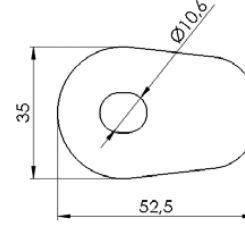

REF. 3959

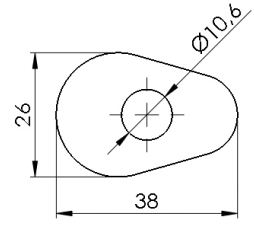

REF. 3960

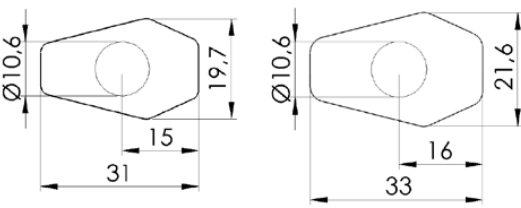

REF. 9655

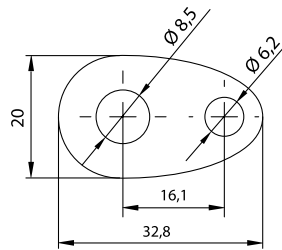

REF. 9676

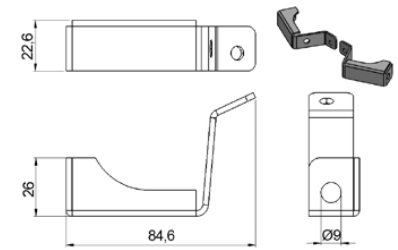

REF. 3528

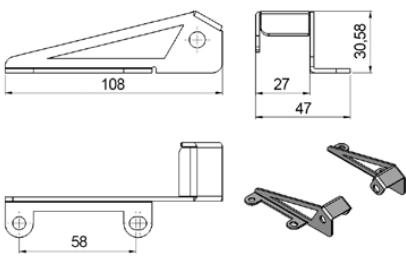

REF. 9740

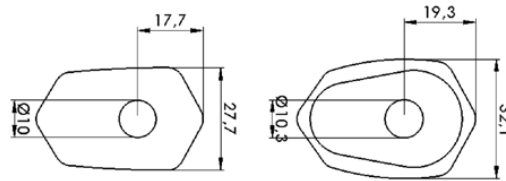

REF. 9788

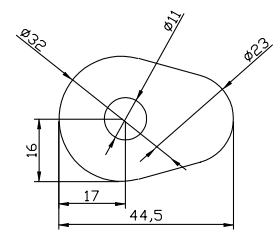

REF. 20867



**MATERIAL**

Made of steel.  
Finished with epoxy black paint.

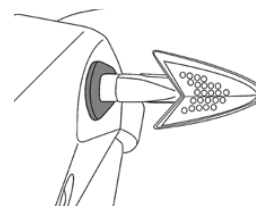

**OPTIC**

Hides the gap that leaves the OEM  
turn signal when it is replaced.



# SEQUENTIAL TURN SIGNALS



\* Check availability for motorcycle models at [www.puig.tv](http://www.puig.tv) typing in the searching window:

**SEQUENTIAL TURN SIGNALS**



TURN SIGNAL



FRONT RUNNING LIGHT



REAR RUNNING LIGHT



STOP LIGHT

■ N Black

**NOTE:** check connections turn signals on page 365.  
To avoid connection problems. Check the technical sheet on page 364.



# NEW!

**HOMOLOGATED**

## RUGGED

MODEL	REF.	N
SET OF SEQUENTIAL COLOR BLACK WITH CLEAR LENS OF LEDS 56 x 12 mm. 12V 1W Thread: M8	21784N	(*)

We cannot guarantee the universality of this turn signal on all motorcycle models.



**HOMOLOGATED**

## THIN

MODEL	REF.	N
SET OF SEQUENTIAL COLOR BLACK WITH CLEAR LENS OF 12 LEDS 76 x 27,40 mm. (LxA) 12V 2,7W Thread: M8	9624N	(*)

We cannot guarantee the universality of this turn signal on all motorcycle models.



**HOMOLOGATED**

## PIN

MODEL	REF.	N
SET OF SEQUENTIAL COLOR BLACK WITH CLEAR LENS OF 8 LEDS 70,20 x 24,30 mm (LxA) 12V 1W Thread: M10	3155N	(*)

We cannot guarantee the universality of this turn signal on all motorcycle models.



**HOMOLOGATED**

## TOWER

MODEL	REF.	N
SET OF SEQUENTIAL COLOR BLACK WITH CLEAR LENS OF 8 LEDS 70 x 24 mm (LxA) 12V-0,5W Thread: M10	20424N	(*)

We cannot guarantee the universality of this turn signal on all motorcycle models.

# TURN SIGNALS



\* Check availability for motorcycle models at [www.piig.tv](http://www.piig.tv) typing in the searching window:

**TURN SIGNALS**

HOMOLOGATED

**NEW!**



## DART

MODEL	REF.	N
SET BLACK CLEAR LENSES LED 26 x 10 mm. 12V 0.9W Thread: M8	21785N	(*)

HOMOLOGATED

**NEW!**



## TAB

MODEL	REF.	N
SET BLACK CLEAR LENSES LED Ø10 x 10 mm. 12V 1W Thread: M6	21749N	(*)

(\*) Check price with your distributor.

 N Black

**NOTE:** check connections turn signals **on page 365.**  
To avoid connection problems. Check the technical sheet **on page 364.**



TURN SIGNAL



FRONT RUNNING LIGHT



REAR RUNNING LIGHT



STOP LIGHT

**HOMOLOGATED**

**HOMOLOGATED**



**PIRAMIDE**

MODEL	REF.	N
SET BLACK CLEAR LENSES LED 59,15 x 33,54 mm (LxA) Thread: M6 12V-0,5W	9941N	(*)



**CHIP**

MODEL	REF.	N
SET BLACK CLEAR LENSES LED 24 x 16 mm (LxA) Thread: M6 12V-0,4W	9942N	(*)

(\*) Check price with your distributor.

**N** Black

**NOTE:** check connections turn signals on page 365.  
To avoid connection problems. Check the technical sheet on page 364.



# TURN SIGNALS



\* Check availability for motorcycle models at [www.puig.tv](http://www.puig.tv) typing in the searching window:

**TURN SIGNALS**

**HOMOLOGATED**



## SPARKLY

MODEL	REF.	N
SET BLACK CLEAR LENSES LED 138,43 x 45,12 mm (LxA) Thread: M8 12V-0,5W	9944N	(*)

**HOMOLOGATED**



## HOUSE

MODEL	REF.	N
SET BLACK CLEAR LENSES LED 70 x 24 mm (LxA) Thread: M10 12V-0,5W	9946N	(*)

(\*) Check price with your distributor.

 N Black

**NOTE:** check connections turn signals **on page 365.**  
To avoid connection problems. Check the technical sheet **on page 364.**



TURN SIGNAL



FRONT RUNNING LIGHT



REAR RUNNING LIGHT



STOP LIGHT

**HOMOLOGATED**



**BUOY**

MODEL	REF.	N
SET BLACK CLEAR LENSES LED 78 x 33 mm (LxA) Thread: M8 12V-5W	9947N	(*)

Milled from aluminum dough.  
They are fixed as a handlebar terminal.  
Suitable for handlebars inner diameter from 18 mm.

**HOMOLOGATED**



**BUOY II**

MODEL	REF.	N
SET BLACK CLEAR LENSES LED 77,80 x 33 mm (LxA) Thread: M10 12V-5W	9948N	(*)

Injected metallic.  
They are fixed as a handlebar terminal.  
Suitable for handlebars inner diameter from 18 mm.

(\*) Check price with your distributor.

**N** Black

**NOTE:** check connections turn signals on page 365.  
To avoid connection problems. Check the technical sheet on page 364.

# TURN SIGNALS



\* Check availability for motorcycle models at [www.piig.tv](http://www.piig.tv) typing in the searching window:

**TURN SIGNALS**

**HOMOLOGATED**



## TINY

MODEL	REF.	N
SET BLACK SMOKED LENSES LED 27 x 34,20 mm (LxA) Thread: M6 12V-1W	9314N	(*)

**HOMOLOGATED**



## MINIMAL

MODEL	REF.	N
JLED TURN SIGNAL BLACK BASE SHORT STEMP/ CLEAR LENS BY PAIR 45 x 20 mm (LxA) Thread: M6 12V-0,6W	4906N	(*)
LED TURN SIGNAL BLACK BASE LONG STEMP/ CLEAR LENS BY PAIR 60 x 20 mm (LxA) Thread: M8 12V-0,8W	4907N	(*)

(\*) Check price with your distributor.

 N Black

**NOTE:** check connections turn signals **on page 365**.  
To avoid connection problems. Check the technical sheet **on page 364**.



TURN SIGNAL



FRONT RUNNING LIGHT



REAR RUNNING LIGHT



STOP LIGHT

**HOMOLOGATED**



**OPEN**

MODEL	REF.	N
SET BLACK CLEAR LENSES LED 47,3 x 26,5 mm. (LxA) Thread: M8 12V-2W	8997N	(*)

**HOMOLOGATED**



**RUBI**

MODEL	REF.	C
SET CARBON LOOK CLEAR LENSES LED 53,30 x 28,10 mm. (LxA) Thread: M10 12V-1W	4919	(*)

-  C Carbon look
-  N Black

(\*) Check price with your distributor.

**NOTE:** check connections turn signals on page 365.  
To avoid connection problems. Check the technical sheet on page 364.



# TURN SIGNALS



\* Check availability for motorcycle models at [www.piig.tv](http://www.piig.tv) typing in the searching window:

**TURN SIGNALS**

**HOMOLOGATED**



## POWER LED

MODEL	REF.	N
SET BLACK CLEAR LENSES LED 70,15 x 21,76 mm (LxA) Thread: M8 12V-1W	5609N	(*)

**HOMOLOGATED**



## PUTT

MODEL	REF.	N
SET BLACK CLEAR LENSES LED 62,8 x 15,4 mm (LxA) Thread: M8 12V-2W	3734N	(*)

(\*) Check price with your distributor.

 N Black

**NOTE:** check connections turn signals **on page 365.**  
To avoid connection problems. Check the technical sheet **on page 364.**



TURN SIGNAL



FRONT RUNNING LIGHT



REAR RUNNING LIGHT



STOP LIGHT

**HOMOLOGATED**



**SNAKE**

MODEL	REF.	N
SET BLACK CLEAR LENSES LED 80 x 28,3 mm. (LxA) Thread: M8 12V-1W	5239N	(*)

**HOMOLOGATED**



**FLECHA**

MODEL	REF.	W
LED TURN SIGNAL SHORT ARM CLEAR LENS 67 x 30 mm. (LxA) Thread: M8 12V-2W	4173W	(*)
LED TURN SIGNAL LONG ARM CLEAR LENS 87 x 30 mm. (LxA) Thread: M8 12V-2W	4174W	(*)

- N Black
- W Clear

(\*) Check price with your distributor.

**NOTE:** check connections turn signals on page 365.  
To avoid connection problems. Check the technical sheet on page 364.

# TURN SIGNALS



\* Check availability for motorcycle models at [www.piig.tv](http://www.piig.tv) typing in the searching window:

**TURN SIGNALS**

**HOMOLOGATED**

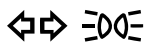

he flashing signal is homologated, not the braking or position signal.



## LIGHT

MODEL	REF.	N
<b>REAR</b> SET BLACK SMOKED LENSES LED 50,80 x 25,30 mm. (LxA) Thread: M8 POSITION + STOP + TURN SIGNAL	9557N	(*)

**HOMOLOGATED**

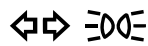

he flashing signal is homologated, not the braking or position signal.



## STICK

MODEL	REF.	N
<b>FRONT</b> SET BLACK SMOKED LENSES LED 48 x 20 mm. (LxA) Thread: M8 POSITION + TURN SIGNAL	9317N	(*)
<b>REAR</b> SET BLACK SMOKED LENSES LED 48 x 20 mm. (LxA) Thread: M8 POSITION + STOP + TURN SIGNAL	9555N	(*)

(\*) Check price with your distributor.

**N** Black

**NOTE:** check connections turn signals **on page 365.**  
To avoid connection problems. Check the technical sheet **on page 364.**



TURN SIGNAL



FRONT RUNNING LIGHT



REAR RUNNING LIGHT

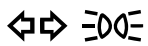

STOP LIGHT

**HOMOLOGATED**

he flashing signal is homologated, not the braking or position signal.



## CURVE

MODEL	REF.	N
<b>FRONT</b> SET BLACK CLEAR LENSES LED 49,50 x 25 mm (LxA) Thread: M8 POSITION + TURN SIGNAL	9084N	(*)
<b>REAR</b> SET BLACK CLEAR LENSES LED 49,50 x 25 mm (LxA) Thread: M8 POSITION + STOP + TURN SIGNAL	9151N	(*)

(\*) Check price with your distributor.

 N Black

**NOTE:** check connections turn signals **on page 365**.  
To avoid connection problems. Check the technical sheet **on page 364**.



# TURN SIGNALS



\* Check availability for motorcycle models at [www.piig.tv](http://www.piig.tv) typing in the searching window:

**TURN SIGNALS**

**HOMOLOGATED**



## ZAFIRO

MODEL	REF.	W
LED TURN SIGNAL SHORT ARM CLEAR LENS 73 x 35 mm (LxA) Thread: M8 12V-1W	2585W	(*)
LED TURN SIGNAL LONG ARM CLEAR LENS 93 x 35 mm (LxA) Thread: M8 12V-1W	2586W	(*)

**HOMOLOGATED**



## LANZA

MODEL	REF.	N
SET BLACK CLEAR LENSES LED 79 x 33 mm (LxA) Thread: M8 12V-0,9W	4824N	(*)

N Black  
 W Clear

(\*) Check price with your distributor.

**NOTE:** check connections turn signals **on page 365**.  
To avoid connection problems. Check the technical sheet **on page 364**.



TURN SIGNAL



FRONT RUNNING LIGHT



REAR RUNNING LIGHT



STOP LIGHT

**HOMOLOGATED**

## PEAK

MODEL	REF.	C N
LED TURN SIGNAL BLACK BASE SHORT STEMP/ CLEAR LENS BY PAIR 66 x 27 mm. (LxA) Thread: M10 12V-0,5W	4491N	(*)
LED TURN SIGNAL BLACK BASE LONG STEMP/ CLEAR LENS BY PAIR 86 x 27 mm. (LxA) Thread: M10 12V-0,5W	4492N	(*)
LED TURN SIGNAL CARBON LOOK BASE SHORT STEMP/ CLEAR LENS BY PAIR 66 x 27 mm. (LxA) Thread: M10 12V-0,5W	4493C	(*)
LED TURN SIGNAL CARBON LOOK BASE LONG STEMP/ CLEAR LENS BY PAIR 86 x 27 mm. (LxA) Thread: M10 12V-0,5W	4494C	(*)

 C Carbon look

 N Black

(\*) Check price with your distributor.

**NOTE:** check connections turn signals on page 365.  
To avoid connection problems. Check the technical sheet on page 364.

# TURN SIGNALS



\* Check availability for motorcycle models at [www.piig.tv](http://www.piig.tv) typing in the searching window:

**TURN SIGNALS**

**HOMOLOGATED**



## CIGAR

MODEL	REF.	N
SET BLACK CLEAR LENSES LED 91 x 20 mm (LxA) Thread: M8 12V-1,4W	4346N	(*)

**HOMOLOGATED**



## AX

MODEL	REF.	N
SET BLACK CLEAR LENSES LED 63,4 x 18,2 mm (LxA) Thread: M8 12V-1W	5510N	(*)

(\*) Check price with your distributor.

 N Black

**NOTE:** check connections turn signals **on page 365**.  
To avoid connection problems. Check the technical sheet **on page 364**.



TURN SIGNAL



FRONT RUNNING LIGHT



REAR RUNNING LIGHT



STOP LIGHT

**NOT HOMOLOGATED****SPEED**

MODEL	REF.	T
BLACK BASE / AMBER LENS BY PAIR 60 x 19 mm.	(*) 2546T	(*)
CARBON LOOK BASE / AMBER LENS BY PAIR 60 x 19 mm. 12V 2,16W	(*) 1077T	(*)

(\*) These models cannot be homologated, because do not fulfill the EU standards, their C-Carbon Look use limited for tradeshows exclusively, closed exhibitions and for race tracks

T Orange

**HOMOLOGATED****BALA**

MODEL	REF.	T
BLACK BASE / AMBER LEN x UNIT 78 x 87 mm. (LxA) Thread: M8	0911T	(*)

(\*) Check price with your distributor.

**NOTE:** check connections turn signals **on page 365**.  
To avoid connection problems. Check the technical sheet **on page 364**.



# TURN SIGNALS



\* Check availability for motorcycle models at [www.piig.tv](http://www.piig.tv) typing in the searching window:

**TURN SIGNALS**

**HOMOLOGATED**



## EYE

MODEL	REF.	N
BLACK BASE / CLEAR LENS BY PAIR 58,7 x 21 mm (LxA) Thread: M8 12V 6W	6475N	(*)
AMBER BULB EYE TURN SIGNAL (BOX 10 UNITS) 12V-6W	4596T	(*)
CLEAR BULB EYE TURN SIGNAL (BOX 10 UNITS) 12V-6W	4596W	(*)

### BULB

 T Orange

 W Clear

 N Black

**HOMOLOGATED**



## TIP

MODEL	REF.	N
BLACK BASE / CLEAR LENS BY PAIR 67,4 x 29 mm (LxA) Thread: M10 12V-21W	6476N	(*)
AMBER BULB TIP TURN SIGNAL (BOX 10 UNITS) 12V-23W	1622T	(*)
CLEAR BULB TIP TURN SIGNAL (BOX 10 UNITS) 12V-23W	1622W	(*)
AMBER BULB TIP TURN SIGNAL (BOX 10 UNITS) 12V-6W	4596T	(*)
CLEAR BULB TIP TURN SIGNAL (BOX 10 UNITS) 12V-6W	4596W	(*)

(\*) Check price with your distributor.

**NOTE:** check connections turn signals **on page 365**.  
To avoid connection problems. Check the technical sheet **on page 364**.



TURN SIGNAL



FRONT RUNNING LIGHT



REAR RUNNING LIGHT



STOP LIGHT

HOMOLOGATED



## STAR

MODEL	REF.	C N T W
LED TURN SIGNAL CARBON LOOK BASE SHORT STEMP/ AMBER LENS + SMOKE LENS + LASER LENS BY PAIR 70 x 35 mm. (LxA) Thread: M10 12V-21W	2548C	(*)
LED TURN SIGNAL CARBON LOOK BASE LONG STEMP/ AMBER LENS + SMOKE LENS + LASER LENS BY PAIR 90 x 35 mm (LxA) Thread: M10 12V-21W	2549C	(*)
LED TURN SIGNAL BLACK BASE SHORT STEMP/ AMBER LENS + SMOKE LENS + LASER LENS BY PAIR 69 x 42 mm (LxA) Thread: M10 12V-21W	4175N	(*)
LED TURN SIGNAL BLACK BASE LONG STEMP/ AMBER LENS + SMOKE LENS + LASER LENS BY PAIR 89 x 42 mm (LxA) Thread: M10 12V-21W	4176N	(*)
CLEAR BULB STAR TURN SIGNAL STAR 12V-23W (BOX 10 UNITS)	21537W	(*)

### BULB

C Carbon look

N Black

W Clear

(\*) Check price with your distributor.

**NOTE:** check connections turn signals **on page 365**.  
To avoid connection problems. Check the technical sheet **on page 364**.

# TURN SIGNALS



\* Check availability for motorcycle models at [www.piig.tv](http://www.piig.tv) typing in the searching window:

**TURN SIGNALS**

**HOMOLOGATED**



## MINI

MODEL	REF.	C T W
LED TURN SIGNAL CARBON LOOK BASE SHORT STEMP/ AMBER + SMOKE LENS + LASER LENS 75 x 37 mm (LxA) Thread: M10 12V-21W	4042C	(*)
LED TURN SIGNAL CARBON LOOK BASE LONG STEMP/ AMBER + SMOKE LENS + LASER LENS 95 x 37 mm (LxA) Thread: M10 12V-21W	4043C	(*)
CLEAR BULB STAR TURN SIGNAL MINI (BOX 10 UNITS) 12V-23W	1622W	(*)
AMBER BULB STAR TURN SIGNAL MINI (BOX 10 UNITS) 12V-23w	1622T	(*)

### BULB

- T Orange
- W Clear

 C Carbon look

(\*) Check price with your distributor.

**NOTE:** check connections turn signals **on page 365**.  
To avoid connection problems. Check the technical sheet **on page 364**.



TURN SIGNAL



FRONT RUNNING LIGHT



REAR RUNNING LIGHT



STOP LIGHT

**HOMOLOGATED**

## MASA

MODEL	REF.	N T W
LED TURN SIGNAL CARBON LOOK BASE SHORT STEMP/ AMBER LENS + SMOKE LENS + LASER LENS BY PAIR 63 x 24 mm (LxA) Thread: M8 12V-21W	4871N	(*)
BAMBER BULB MASA TURN SIGNAL (BOX 10 UNITS) 12V-23W	1622T	(*)
CLEAR BULB MASA TURN SIGNAL (BOX 10 UNITS) 12V-23W	1622W	(*)
BAMBER BULB MASA TURN SIGNAL (BOX 10 UNITS) 12V-6W	4596T	(*)
CLEAR BULB MASA TURN SIGNAL (BOX 10 UNITS) 12V-6W	4596W	(*)

### BULB

T Orange

W Clear

N Black

(\*) Check price with your distributor.

**NOTE:** check connections turn signals **on page 365**.  
 To avoid connection problems. Check the technical sheet **on page 364**.



# RESISTOR SET FOR LEDS TURN SIGNALS AND FLASHER RELAYS



\* Check availability for motorcycle models at [www.puig.tv](http://www.puig.tv) typing in the searching window:

**RESISTANCES**

## TECHNICAL INFO TURN SIGNALS CONNECTIONS:

Most of the bikes use bi-metallic relays. Its frequency (which is the one that sets the pace of the turn signals) depend on the amperage circulating through the circuit. When replacing the turn signals from OEM to aftermarket ones which carry a difference power, consequently they vary the amperage circulation through the circuit that causes a change on the frequency of the turn signals rhythm. If otherwise, the motorcycle uses electronic relay (which frequency works independently from the amperage circulating through the circuit) the change of turn signals from OEM to aftermarket, should not affect the frequency of the turn signals rhythm.

• **Note:** In case of doubt of what type of relay the motorcycle uses, we recommend to check the turn signal rhythm after switching from OEM to aftermarket.

If the OEM turn signals are replaced by aftermarket ones that use incandescent bulbs, we need to check they use the same power. In case it is different, we need to replace the turn signals bulbs for others that use the same power as OEM ones. On our catalog, we have available bulbs of different power.

If the OEM turn signals are replaced by LED ones (of much less power than incandescent bulbs), we have two options to balance the frequency of rhythm:

**1.** Incorporate a parallel relay in the right circuit and the other on the left circuit. If we replace four turn signals, we need to use a resistance **Part# 42980**.

If otherwise, only two turn signals are replaced (one on each side), we need to use a resistance **Part# 58730**.

The resistances are supplied with a scheme for a parallel connection.

• **Note:** On most of the bikes, the warning function of the bike is disabled if the resistance is used.

**2.** Identify the intermittent relay of the motorcycle (location and number of pins) and replace it for its corresponding from the list supplied on most of the bikes, the warning functions work correctly when the relay is replaced.

• **Note:** we can find some motorcycles in the market that do not have an intermittent relay, obviously in this case it cannot be replaced. Moreover, if on the blinking function intervenes more than one relay, it is possible that replacing only one relay does not solve the problem.

• **Note:** some LED turn signals flash faster than normal when connected to power (it is normal to check the polarity of the cables with the flashing function activated). To verify the actual flashing frequency, remove all power by turning the key to the "off" position and then move to the "on" position to activate the flashing function.

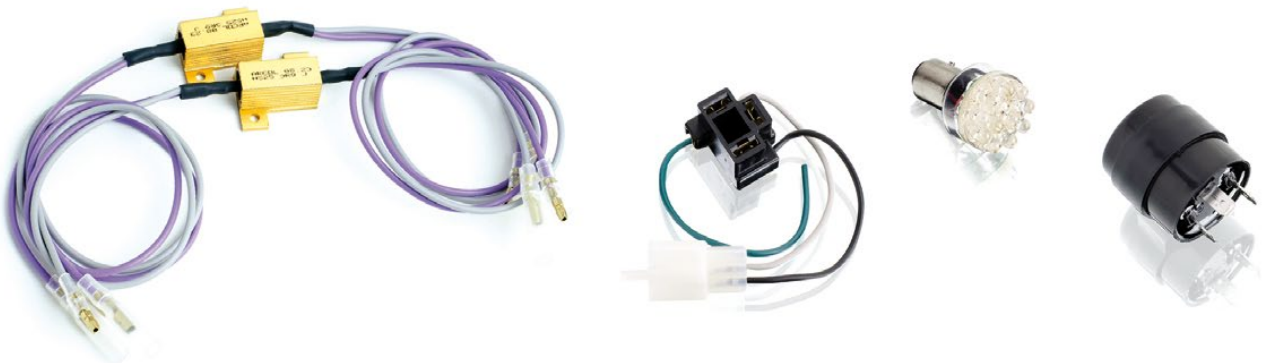

MODEL	REF.	NOT
RESISTORS SET OF 3.9Ω 25w FOR LEDS TURN SIGNALS	42980	(*)
RESISTORS SET OF 18Ω 25w FOR MOTORCYCLES THAT MOUNT REAR LEDS TURN SIGNALS, KEEPING ORIGINAL TURN SIGNALS	58730	(*)
FLASHER RELAY 2 PINS 12V/1W-100W	4823N	(*)
FLASHER RELAY 3 PINS 12V/1W-100W	4822N	(*)
FLASHER RELAY 4 PINS 12V/1W-100W	5180N	(*)
FLASHER RELAY 7 PINS 12V/1W-100W	3540N	(*)
LED LAMP AMBER FOR TURN SIGNAL	1625T	(*)

(\*) Check price with your distributor.

N Black

O Gold

T Orange

# CONNECTORS LEADS



\* Check availability for motorcycle models at [www.puig.tv](http://www.puig.tv) typing in the searching window:

**CONNECTORS LEADS**



REF. 3164

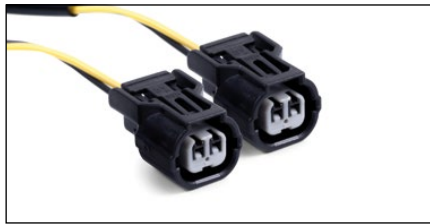
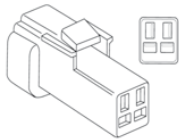

REF. 3703

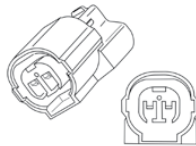

REF. 3704

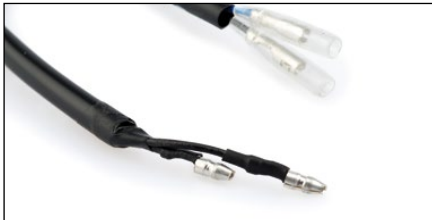
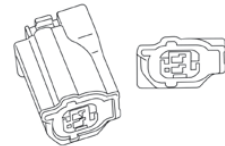

REF. 3846

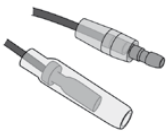

REF. 3849

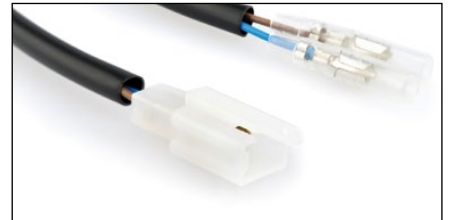
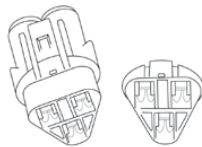

REF. 3850

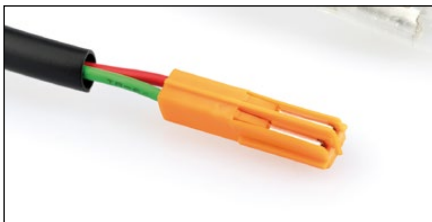
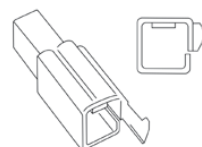

REF. 3853

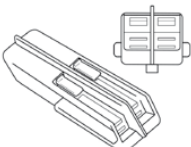

REF. 3871

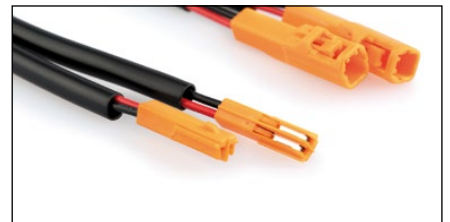
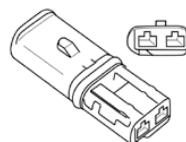

REF. 3873

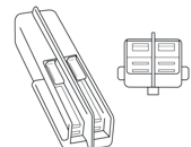

# CONNECTORS LEADS



\* Check availability for motorcycle models at [www.puig.tv](http://www.puig.tv) typing in the searching window:

**CONNECTORS LEADS**

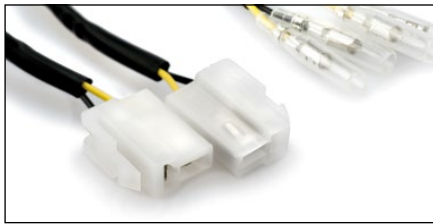

REF. 3888

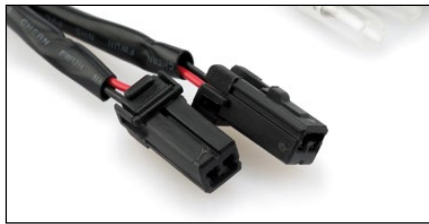
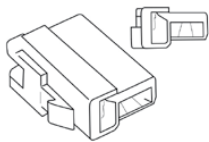

REF. 3889

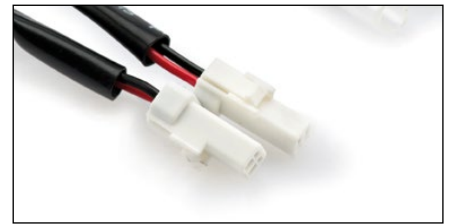
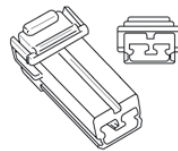

REF. 3890

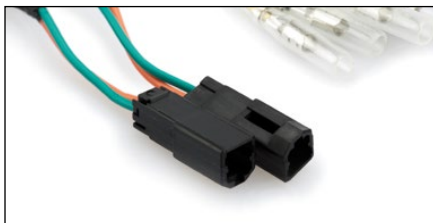
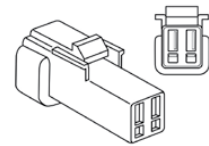

REF. 3891

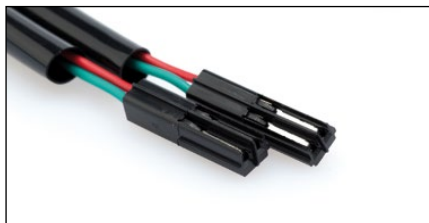
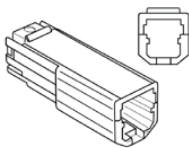

REF. 4854

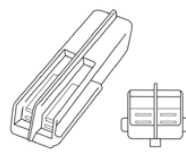

REF. 4856

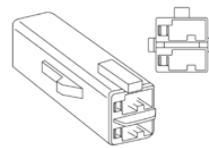

REF. 4860

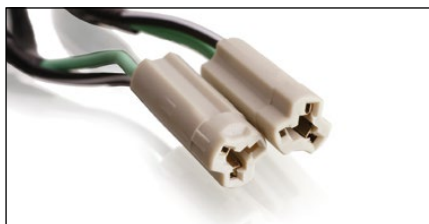
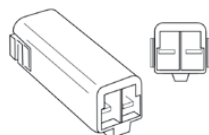

REF. 4863

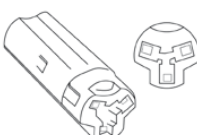

REF. 4869

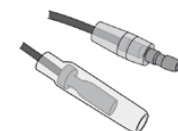



REF. 8510

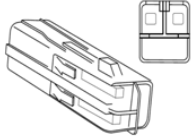

REF. 9772

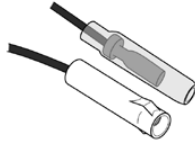

REF. 20312

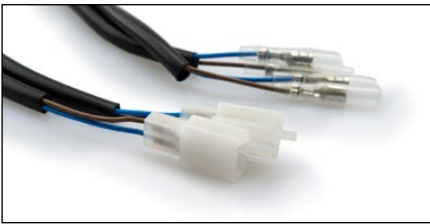
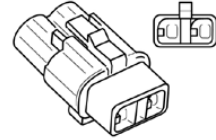

REF. 20545

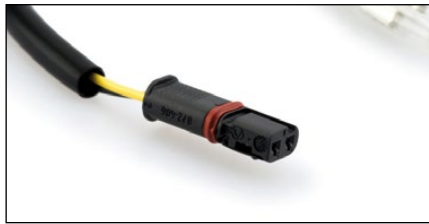
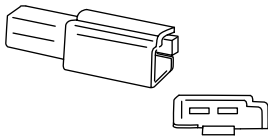

REF. 20546

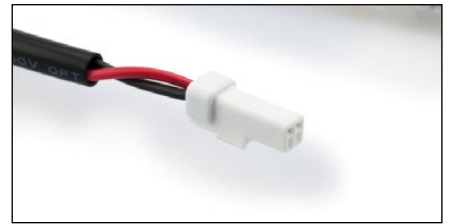
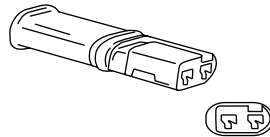

REF. 20547

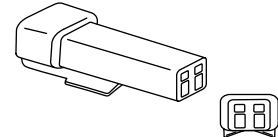

REF. 20554

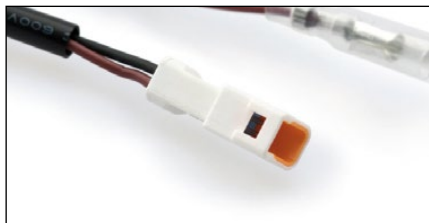
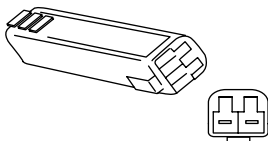

REF. 20566

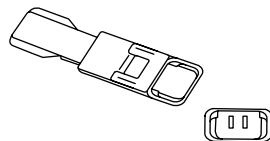

REF. 20570

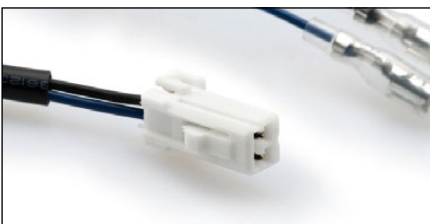
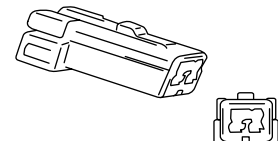

REF. 20587

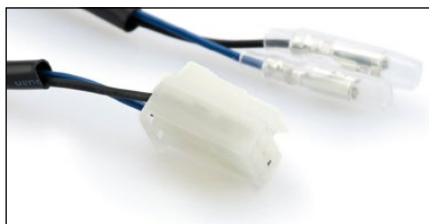
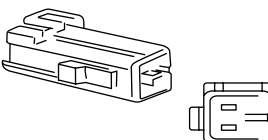

REF. 20588

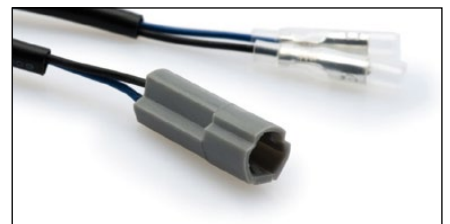
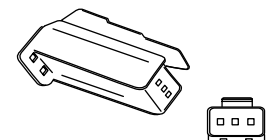

REF. 20589

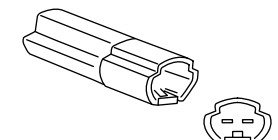



# CONNECTORS LEADS



\* Check availability for motorcycle models at [www.puig.tv](http://www.puig.tv) typing in the searching window:

**CONNECTORS LEADS**



REF. 20590

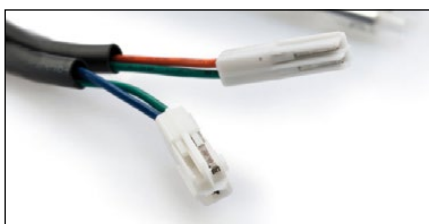
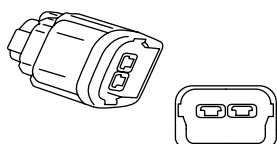

REF. 20591

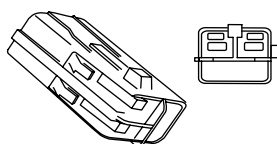

REF. 20730

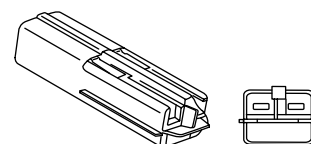

REF. 20627

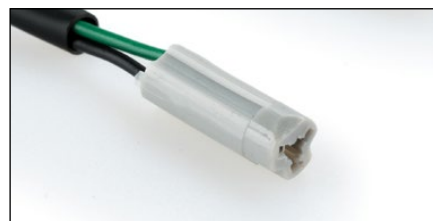
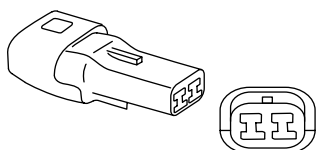

REF. 20731

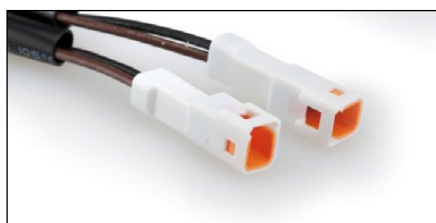
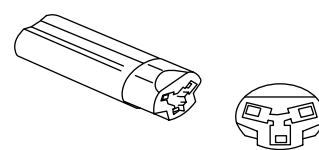

REF. 20760

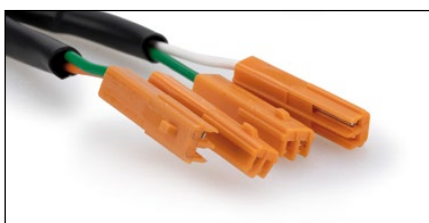
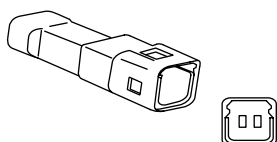

REF. 21582

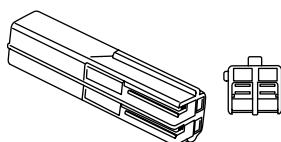

# INTEGRATED TURN SIGNALS



\* Check availability for motorcycle models at [www.puig.tv](http://www.puig.tv) typing in the searching window.

## INTEGRATED TURN LIGHTS

**HOMOLOGATED**

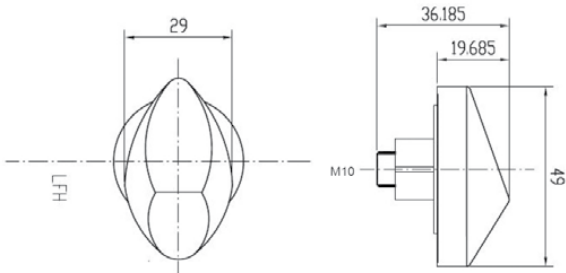

REF. 4487

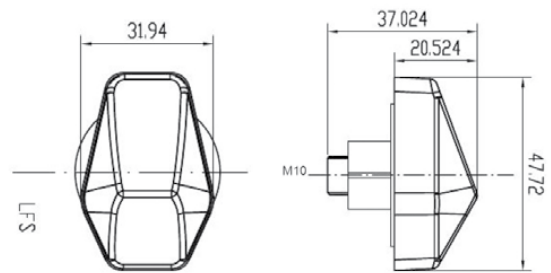

REF. 4488

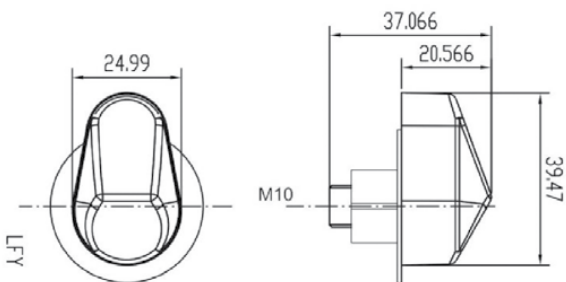

REF. 4489

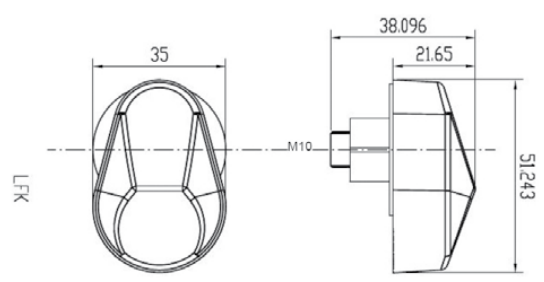

REF. 4490

REF.	POWER
4487K	12V-2W
4488K	12V-1W
4489K	12V-1W
4490K	12V-2W

**NOTE:** technical characteristics: 12V-0,5W.

To avoid connection problems. Check the technical sheet on page 364.

# 5

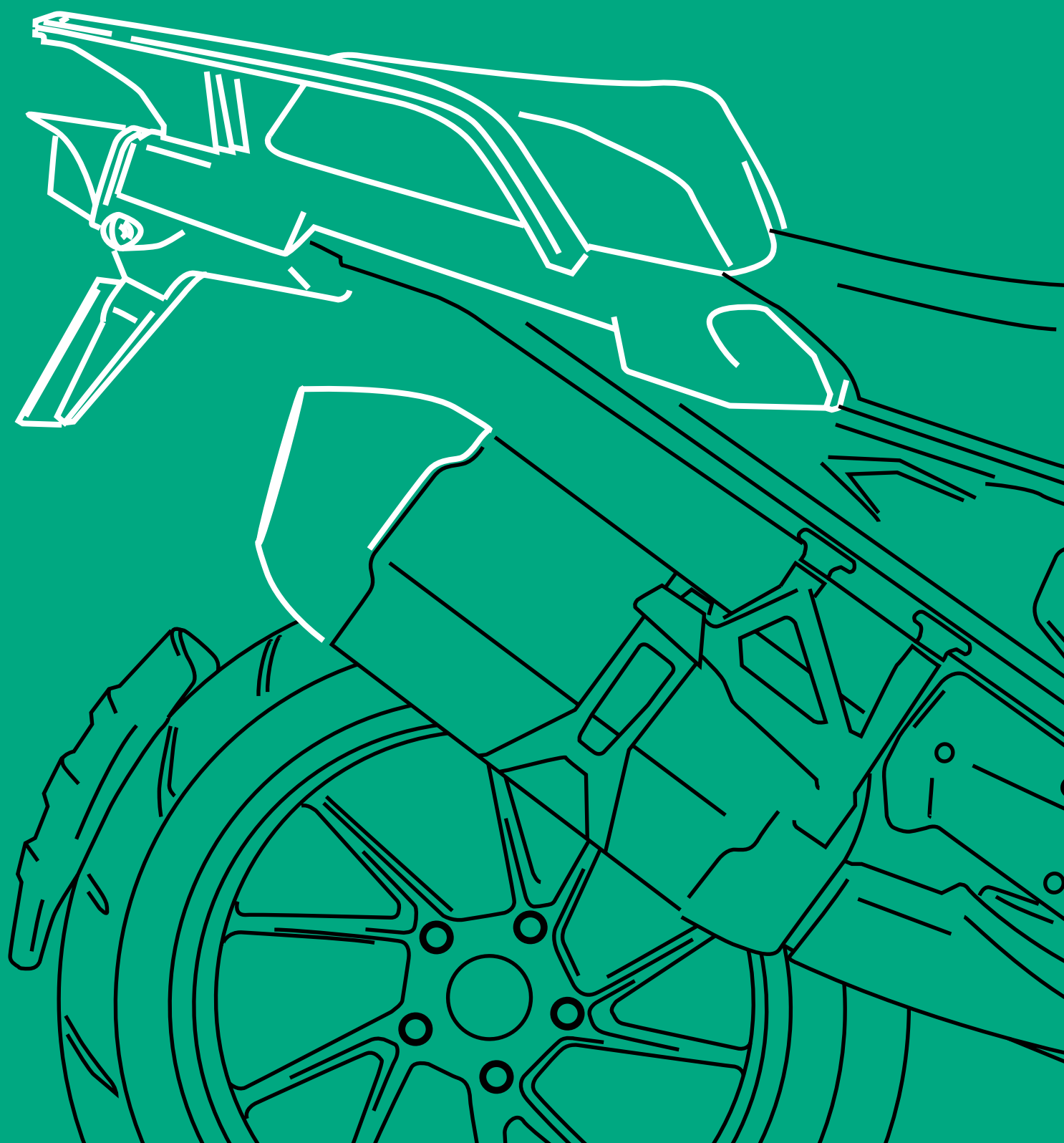

# REAR AREA

END TUBE FOR EXHAUST	<b>382</b>
EXHAUST PROTECTOR	<b>384</b>
LICENSE SUPPORTS	<b>374</b>
LIGHTING LICENSE SUPPORT	<b>376</b>
REAR BRAKE TANK COVER	<b>386</b>
REAR HANDLES COVERS	<b>387</b>
REAR SEAT COWLS	<b>372</b>
SUPPORT FOR ORIGINAL TURN SIGNAL	<b>378</b>
TAIL LIGHTS	<b>380</b>



# REAR SEAT COWLS



\* Check availability for motorcycle models at [www.puig.tv](http://www.puig.tv) typing in the searching window:

**REAR SEAT COWLS**



NO DRILL



ABS



AERODYNAMIC

 C Carbon look

 J Matt black



REF. 20705C



REF. 20704J

Made to convert the motorcycle into a single-seater while providing a personalized and sport look similar to competition motorcycles.

Its studied design includes internal channels that, in addition to lightening the assembly, help to reduce the turbulence generated by the air, improving the stability of the motorcycle, especially at high speeds.

The front part of the tail incorporates a black foam for better rider comfort when sheltering at high speeds. This piece is made of matte black ABS plastic or 4 mm. thick resistant and light carbon simile. Its assembly is very simple since the Puig tail cover uses the same anchoring system as the passenger seat it replaces. All you have to do is remove the passenger seat and put the Puig rear seat cowls.



# LICENSE SUPPORTS



\* Check availability for motorcycle models at [www.puig.tv](http://www.puig.tv) typing in the searching window:

**LICENSE SUPPORTS**



Replace the original license plate holder of your motorcycle with the Puig license plate holder. Its elevated location gives a Racing character to your motorcycle. The set combines steel parts finished in epoxy paint with parts in Polyamide, achieving a significant reduction in weight compared to the original support.

■ I Stainless Steel

■ N Black

■ R Red



REF. 9353N

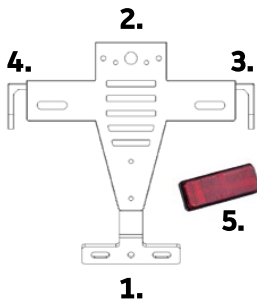

**KIT**

It is supplied with light and reflector, both homologated. According to models.



**ADJUSTABLE**

Fixed or adjustable on inclination.

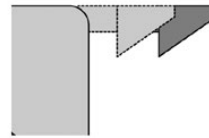

**TURN SIGNALS**

Adjustable lodge for turn signals.

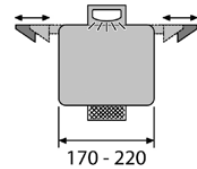

**UNIVERSAL**

Most suitable for license plates.

The license support is not designed to mount the oem turn signals.  
Oem connectors are not delivered to connect lighting license.

MODEL	REF.	I N R
METALLIC SUPPORT TO MOVE THE REFLECTOR (1)	4480I	(*)
NYLON SUPPORT TO DISPLACE THE REFLECTOR (1)	1553N	(*)
NYLON SUPPORT FOR LICENSE PLATE (2)	1558N	(*)
NYLON SUPPORT FOR TURN SIGNAL RIGHT (3)	1559N	(*)
NYLON SUPPORT FOR TURN SIGNAL left (4)	1615N	(*)
REFLECTOR HOMOLOGATED 8,8 x 3,4 cm. C/RED (5)	4481R	(*)
REFLECTOR HOMOLOGATED 7,5 x 2,5 cm. C/RED (5)	5729R	(*)

UNIVERSAL MODELS	ADJUSTABLE	TURN SIGNAL SUPPORT	INCLUDE KIT	REF.	N
UNIVERSAL	YES/NO	YES ADJUST.	NO	1539N	(*)

(\*) Check price with your distributor.

**NOTE:** The license plate holder part number does not include the extension of the lighting group wiring. **See available extensions page 365.**  
Lighting license supports **see page 376.**  
Turn signals for license plate holder **see page 344.**  
Support for original turn signal **see page 378.**



# LIGHTING LICENSE SUPPORT



\* Check availability for motorcycle models at [www.puig.tv](http://www.puig.tv) typing in the searching window:  
**LICENSE LIGHT**



**HOMOLOGATED**

## ANGLE

MODEL	REF.	N
LICENSE LIGHT SUPPORT MODEL ANGLE WITH LEDS (48 x 19 mm.)	20768N	(*)

Made in black plastic suitable for our licence supports.



**HOMOLOGATED**

## PLA

MODEL	REF.	N
LICENSE LIGHT SUPPORT MODEL PLA WITH LEDS (45 x 20 mm.)	5577N	(*)

Made in black plastic suitable for our licence supports.

**HOMOLOGATED**
**ALU**

MODEL	REF.	N
LICENSE LIGHT SUPPORT MODEL ALU WITH LEDS (45 x 20 mm.)	5565N	(*)

Made in aluminium anodized suitable for our licence supports.

**HOMOLOGATED**
**MIG**

MODEL	REF.	N
LICENSE LIGHT SUPPORT MODEL MIG WITH LEDS (56 x 26 mm.)	4646N	(*)

Made in black plastic suitable for our licence supports.

**HOMOLOGATED**
**TRO**

MODEL	REF.	N
LICENSE LIGHT SUPPORT MODEL TRO WITH LEDS (56 x 26 mm.)	4645N	(*)

Made in aluminium anodized suitable for our licence supports.

# SUPPORT FOR ORIGINAL TURN SIGNAL



\* Check availability for motorcycle models at [www.puig.tv](http://www.puig.tv) typing in the searching window.

**SUPPORT TURN LIGHT**



With this support, you will be able to improve the image of your motorcycle and mount the Puig license plate holders without having to modify the original turn signal of the bike.

The piece is made of steel and finished in black EPOXY paint.



REF. 9320N

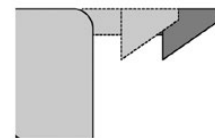
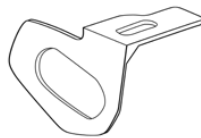

#### FUNCTION

They allow the assembly of the original turn signals in the PUIG license plate holders.

#### MATERIAL

Made of steel.  
Finished with epoxy black paint.

#### OPTIC

Hides the empty section left by the original turn signal once replaced.



# TAIL LIGHTS



\* Check availability for motorcycle models at [www.puig.tv](http://www.puig.tv) typing in the searching window:

**REAR RUNNING LIGHT**

## HOMOLOGATED

1.



2.



3.



4.



5.



## OVAL

MODEL	REF.	N W
1. <b>SMILE</b> - BRAKE TAIL LIGHT CLEAR LENS W/LED WITH LICENSE LIGHT 110 x 25 mm. 12V-1W/1W	1359W	(*)
2. <b>LIB</b> - BRAKE TAIL LIGHT CLEAR LENS W/LED WITH LICENSE LIGHT 100 x 30 mm.	4818N	(*)
3. BRAKE TAIL LIGHT CLEAR LENS W/LED WITH LICENSE LIGHT 85 x 20 mm.	6073W	(*)
4. <b>SMILE II</b> - BRAKE TAIL LIGHT CLEAR LENS W/LED WITH LICENSE LIGHT 83 x 20 mm. 12V 0,1W/0,9W	6493W	(*)
5. <b>SHARK</b> - BRAKE TAIL LIGHT CLEAR LENS W/LED WITH LICENSE LIGHT 83 x 20 mm. 12V-1W/1W	4605W	(*)

N Black  
 W Clear

(\*) Check price with your distributor.

**HOMOLOGATED**

1.



2.



## ELONGATED

	MODEL	REF.	R
1.	BRAKE TAIL LIGHT W/LEDS 150 x 20 mm.	(*) 0959R	(*)
2.	TT - BRAKE TAIL LIGHT W/LEDS 75 x 15 mm. <b>HOMOLOGATED</b>	4602R	(*)

(\*) These models cannot be homologated, because do not fulfill the EU standards, their C-Carbon Look use limited for tradeshow exclusively, closed exhibitions and for race tracks



## WITH PLASTIC BASE

	MODEL	REF.	N
	SKIRT + BREAK LIGHT + POSITION LEDES + LICENSE PLATE POSITION LED LIGHT 12V-1W/1W	4312N	(*)

N Black  
 R Red

(\*) Check price with your distributor.

# END TUBE FOR EXHAUST



\* Check availability for motorcycle models at [www.puig.tv](http://www.puig.tv) typing in the searching window:

**RING TUBE**



**A** Blue  
**N** Black

**O** Gold  
**R** Red



REF. 7358R



REF. 95420



The end ring for the Yamaha exhaust pipe T-MAX and Kymco AK is part of Puig's Hi-Tech Parts customization catalog.

From billet aluminum and featuring a colorful, high-quality anodized finish, its attractive minimalist design is available in blue, black, gold and red, so that each user can choose between a discreet and elegant tuning or a more striking color for these sports maxiscooter.



# EXHAUST PROTECTOR



\* Check availability for motorcycle models at [www.puig.tv](http://www.puig.tv) typing in the searching window:

**EXHAUST PROTECTOR**



**NEW!**



REF. 21728N

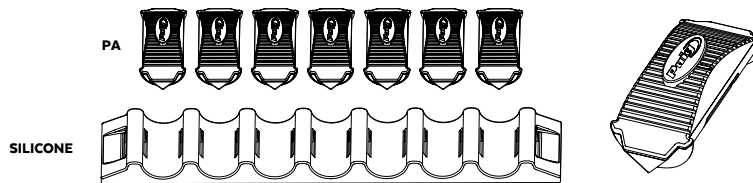

Replacement parts for the Polyamide rollers can be supplied.

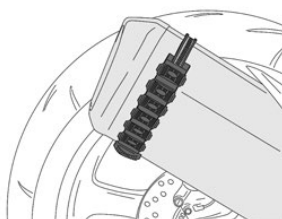

**FUNCTION**

Protect the exhaust in case of a fall.

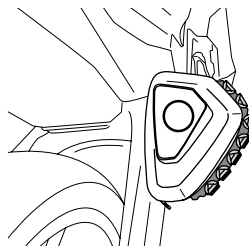

**MATERIAL**

Silicone base to withstand the temperature of the exhaust and cushion the blow + Polyamide rollers.

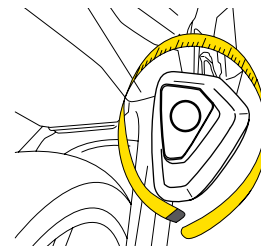

**MOUNTING**

They can be mounted on any shape of exhaust pipe as long as they have a development between 170 mm. and 600 mm.

MODEL	Ø	REF.	N
UNIVERSAL	170 - 600 mm.	21728	(*)

(\*) Check price with your distributor.

# REAR BRAKE TANK COVER



\* Check availability for motorcycle models at [www.puig.tv](http://www.puig.tv) typing in the searching window:

**FLUID TANK CAP**



## ABS

Give a different touch to your bike and protect one of the most sensitive parts of your YAMAHA MT-09/MT-07/MT-09 Tracer / FZ-09 / FZ-07 / FJ-09 / MT-07 Tracer with the cover for the Puig rear brake fluid reservoir.

Made of ABS material highly resistant to impacts, it will provide you with all the security needed by the brake fluid reservoir. The cover is available in matte black and carbon like to give the sporty touch you like so much. Mounting instructions will be provided for proper fixing.



REF. 7578J

 C Carbon look

 J Matt black



# REAR HANDLES COVERS



\* Check availability for motorcycle models at [www.puig.tv](http://www.puig.tv) typing in the searching window.

**TRIM TABS**



## ABS

One of the most aesthetically controversial parts of the BMW R1200R is its back, as it contains handles for the passenger that are not liked by all users.

Puig offers the possibility of replacing these handles with a trim made of ABS and finished in matt black, adapting perfectly to the motorcycle and improving its aesthetics.

The covers are available for the BMW 1200R/1250R and BMW R1200RS/R1250RS.



REF. 9083J

**J** Matt black



# 6

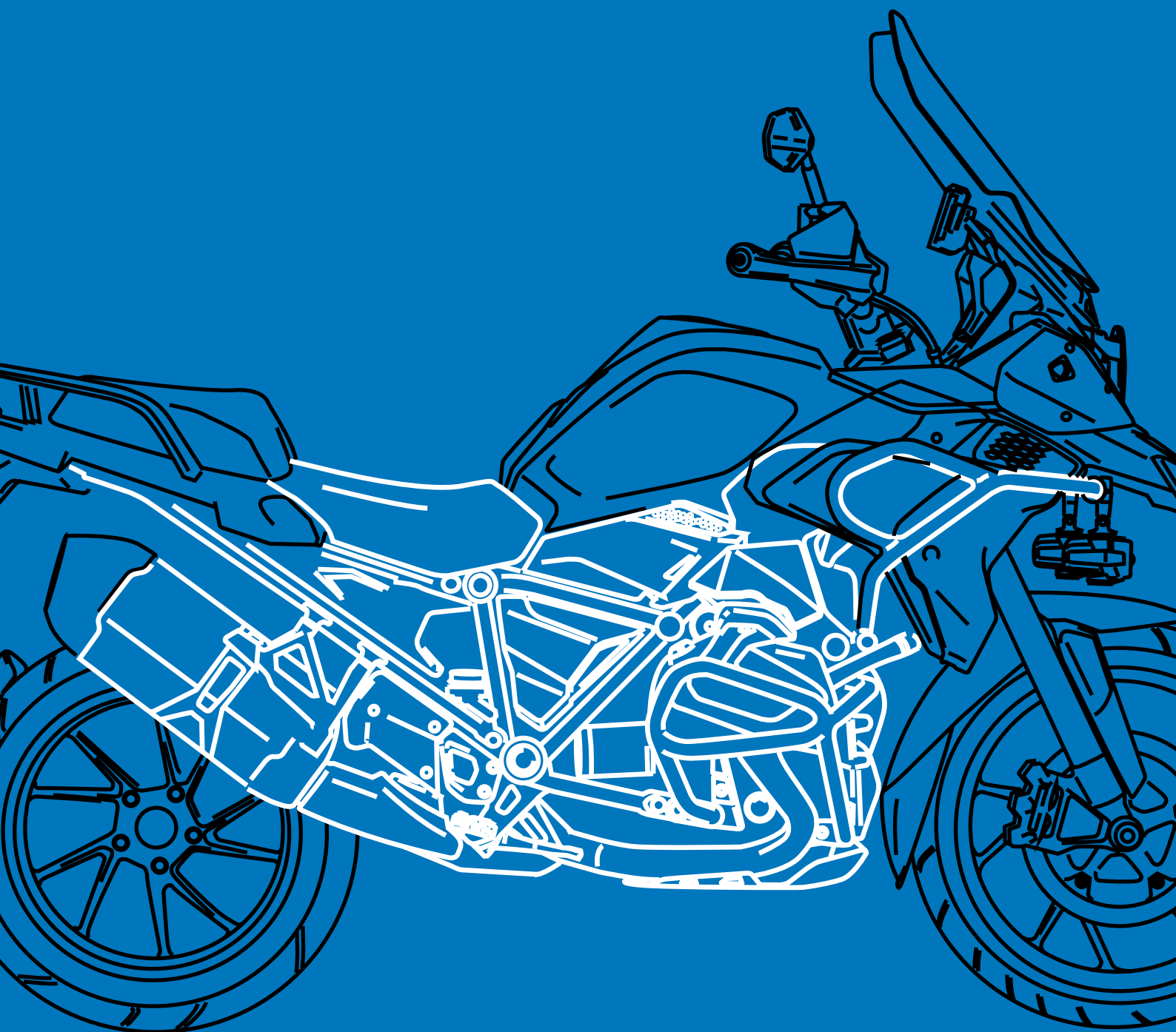

# CHASSIS-ENGINE AREA

ALUMINIUM CHASSIS COVERS	<b>431</b>
ALUMINIUM FILTER COVER, CLUTCH COVER AND SPROCKET COVER	<b>428</b>
APPROVED ENGINE COVER PROTECTOR KIT	<b>427</b>
BRAKE / CLUTCH LEVER	<b>390</b>
CHAIN TENSIONERS	<b>410</b>
CHASSIS CAP COVERS	<b>430</b>
CROWN COIL	<b>413</b>
ENGINE GUARDS	<b>424</b>
ENGINE PROTECTIVE COVERS	<b>426</b>
ENGINE SPOILERS	<b>416</b>
EXHAUST PROTECTOR - DEFLECTOR	<b>435</b>
FRAME SLIDERS PRO 2.0	<b>418</b>
FRAME SLIDERS R19	<b>420</b>
FRAME SLIDERS VINTAGE 2.0	<b>422</b>
HERITAGE FOOTPEGS	<b>402</b>
KICKSTAND EXTENSION	<b>408</b>
OFF-ROAD FOOTPEGS	<b>400</b>
OIL-CARTER GUARD	<b>414</b>
PLUG-OIL CAPS TRACK	<b>404</b>
PROTECTIVE SHIFT LEVER SLEEVE	<b>392</b>
R-FIGHTER / R-FIGHTER S FOOTPEGS	<b>394</b>
RACING / SPORT FOOTPEGS	<b>396</b>
REAR DEFLECTORS	<b>434</b>
SHAFT COVER	<b>412</b>
SHOE PROTECTOR	<b>393</b>
SIDE PANELS	<b>432</b>
SPOOLS	<b>406</b>
TRAIL 2.0 / ENDURO 2.0 FOOTPEGS	<b>398</b>

# BRAKE / CLUTCH LEVER



\* Check availability for motorcycle models at [www.puig.tv](http://www.puig.tv) typing in the searching window:

**PEDAL**

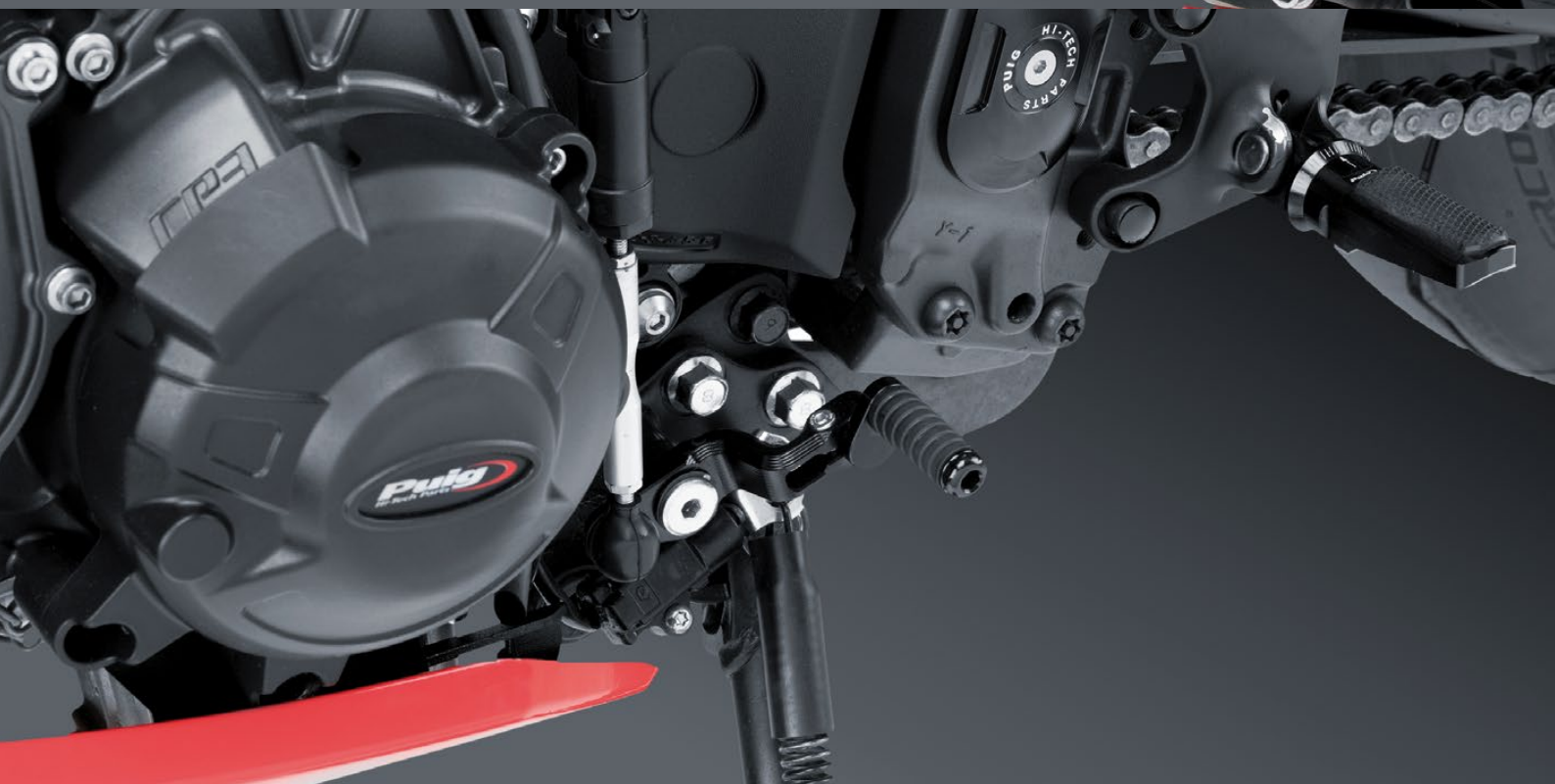
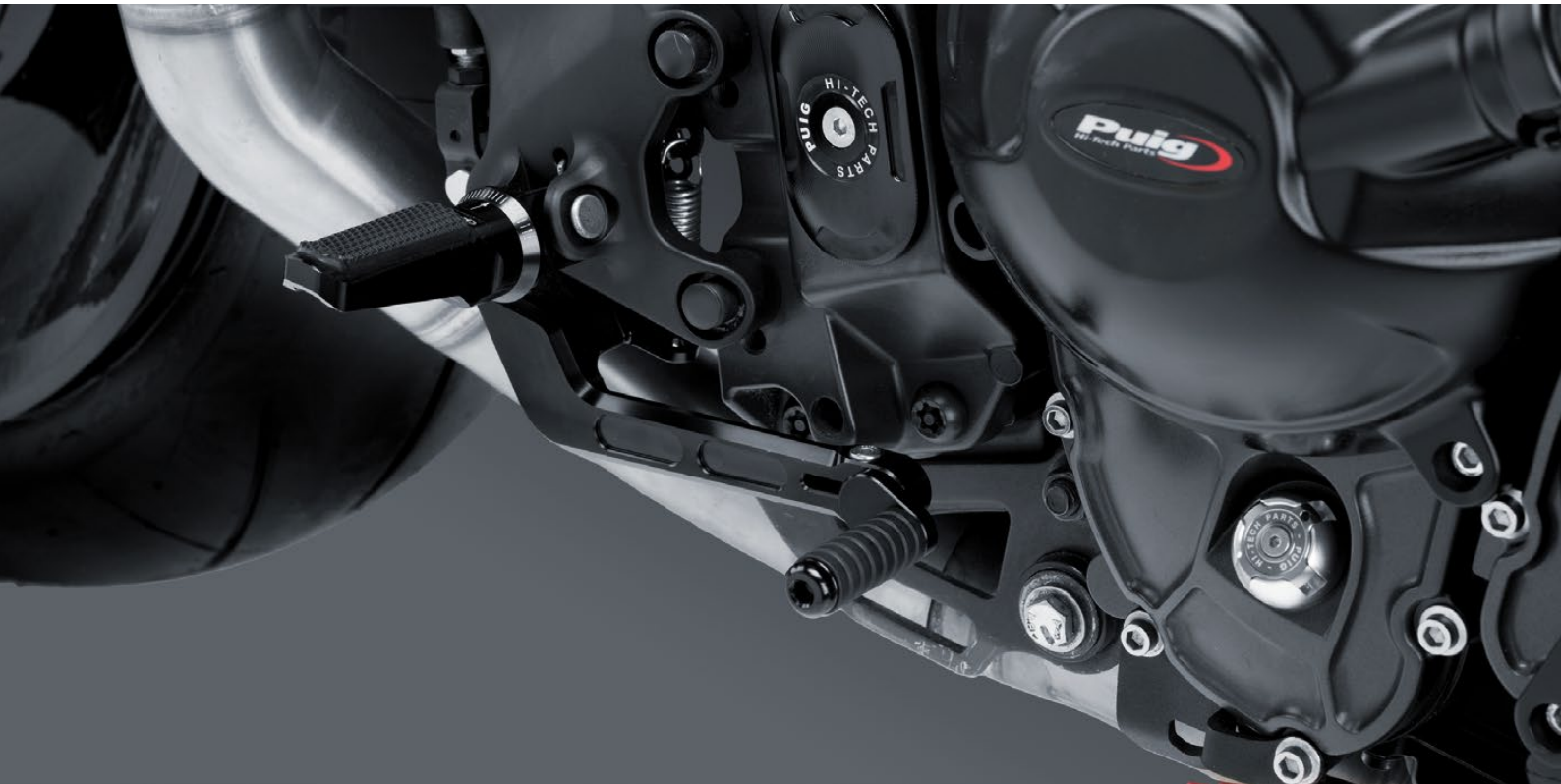

**A** Blue  
**N** Black

**O** Gold  
**P** Silver

**R** Red  
**T** Orange

**V** Green



REF. 21470A



REF. 21469A



REF. 21470N



REF. 21470O



REF. 21470P

REF. 21469N

REF. 21469O

REF. 21469P



REF. 21470R



REF. 21470T



REF. 21470V

REF. 21469R

REF. 21469T

REF. 21469V

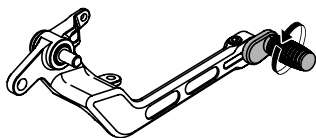

ADJUSTABLE

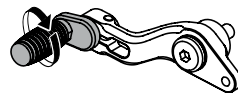

ADJUSTABLE

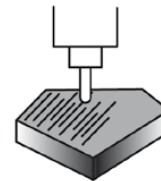

CNC MACHINED

Machined from billet aluminium and anodized in different colors.

Machined from an aluminum block, they are light as well as resistant, they have a black anodized finish to give them a perfect finish and easy to combine with most motorcycles on the market.

They also have an adjustable lever, which allows it to be quickly and easily adjusted to the position preferred by each rider according to their needs and riding style. Both the base of the clutch lever and the brake lever incorporate a rubber coating with non-slip grooves to improve grip and feel when using them.



# PROTECTIVE SHIFT LEVER SLEEVE



\* Check availability for motorcycle models at [www.puig.tv](http://www.puig.tv) typing in the searching window:

**PEDAL COVER**

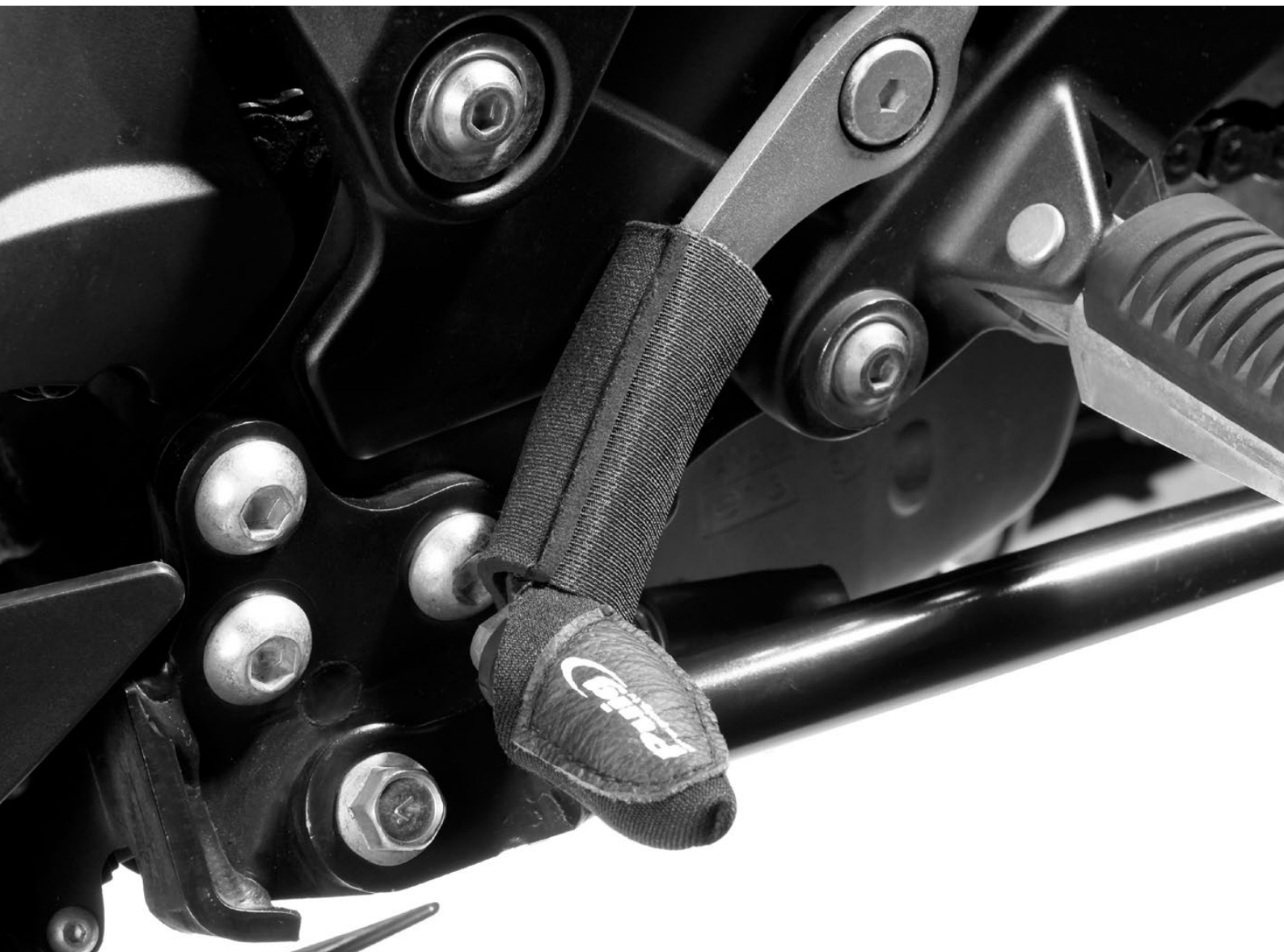

MODEL	REF.	N
PROTECTIVE SHIFT LEVER SLEEVE	5248N	(*)

(\*) Check price with your distributor.



REF. 5248N

■ N Black

# SHOE PROTECTOR



\* Check availability for motorcycle models at [www.puig.tv](http://www.puig.tv) typing in the searching window:

**SHOES**



REF. 21338N

MODEL	REF.	N
SHOE PROTECTOR	21338N	(*)

(\*) Check price with your distributor.

 N Black

# R-FIGHTER / R-FIGHTER S FOOTPEGS



**A** Blue  
**N** Black

**O** Gold  
**P** Silver

**R** Red  
**T** Orange

**V** Green

R-FIGHTER S

**U** Rubber



REF. 91920



\* Check availability for motorcycle models at [www.puig.tv](http://www.puig.tv) typing in the searching window:

**R-FIGHTER**

### R-FIGHTER

MODEL	REF.	A N O P R T V
R-FIGHTER FOOTPEGS BY PAIR	9192	(*)
ADAPTERS BY PAIR	<b>CHECK WEB</b>	
ADJUSTABLE HARDWARE SET	<b>CHECK WEB</b>	
RELOCATION BRACKETS SET 20 mm.	3838	(*)
RELOCATION BRACKETS SET 40 mm.	3839	(*)

(\*) Check price with your distributor.

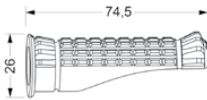

#### DIMENSIONS

74,5 x 26 mm.

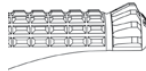

#### DESIGN

Its design offers the best grip.



#### REGULATION

On inclination.



#### PRECISE ADJUSTER

Add marks for proper regulation.

REF. 9193P



\* Check availability for motorcycle models at [www.puig.tv](http://www.puig.tv) typing in the searching window:

**R-FIGHTER S**

### R-FIGHTER S

MODEL	REF.	A N O P R T V
R-FIGHTER S FOOTPEGS BY PAIR	9193	(*)
R-FIGHTER S RUBBERS BY PAIR	9335U	(*)
ADAPTERS BY PAIR	<b>CHECK WEB</b>	
ADJUSTABLE HARDWARE SET	<b>CHECK WEB</b>	
RELOCATION BRACKETS SET 20 mm.	3838	(*)
RELOCATION BRACKETS SET 40 mm.	3839	(*)

(\*) Check price with your distributor.

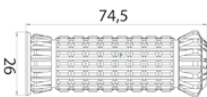

#### DIMENSIONS

74,5 x 26 mm.

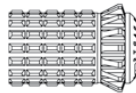

#### DESIGN

Rubber base to reduce vibrations.

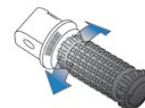

#### REGULATION

On inclination.



#### PRECISE ADJUSTER

Add marks for proper regulation.

**NOTE:** to mount Puig footpegs, we use parts of oem footpegs.

**Footpegs for riders:** all models compatible.

**Footpegs for passanger:** all models compatible except trail and enduro footpegs.



# RACING / SPORT FOOTPEGS

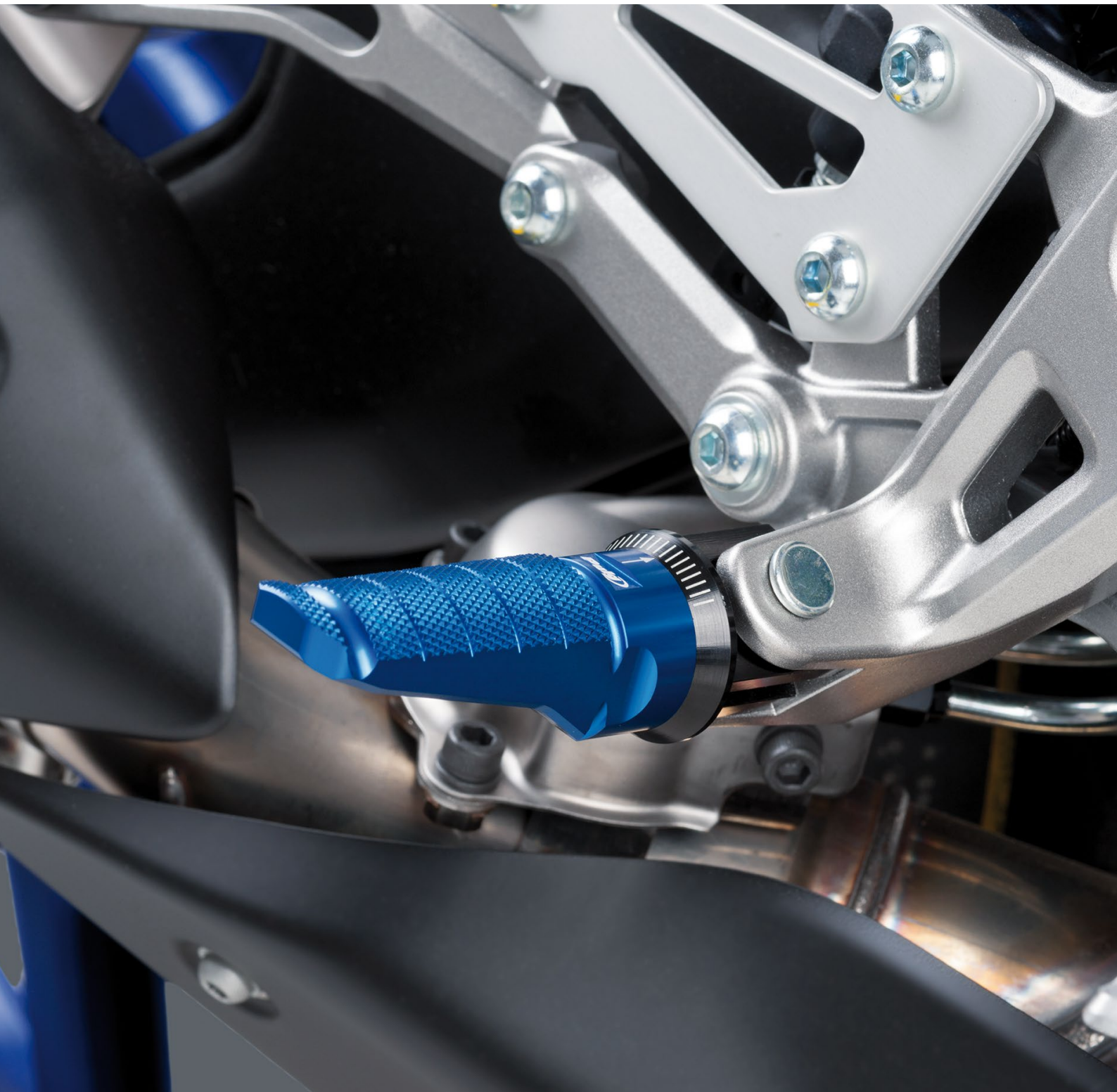

**A** Blue  
**N** Black

**O** Gold  
**P** Silver

**R** Red  
**T** Orange

**V** Green

## SPORT

**H** Rubber  
**N** Rubber

REF. 6301V



\* Check availability for motorcycle models at [www.puig.tv](http://www.puig.tv) typing in the searching window:  
**RACING FOOTPEGS**

## RACING

MODEL	REF.	A N O P R T V
RACING FOOTPEGS BY PAIR	6301	(*)
ADAPTERS BY PAIR	<b>CHECK WEB</b>	
ADJUSTABLE HARDWARE SET	<b>CHECK WEB</b>	
RELOCATION BRACKETS SET 20 mm.	3838	(*)
RELOCATION BRACKETS SET 40 mm.	3839	(*)

(\*) Check price with your distributor.

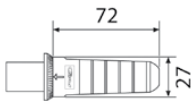

### DIMENSIONS

72 x 27 mm.

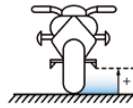

### DESIGN

Its design offers the best grip.

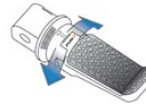

### REGULATION

On inclination.

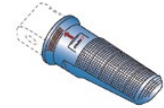

### PRECISE ADJUSTER

Add marks for proper regulation.

1. REF. 7318T



2. REF. 9189N



\* Check availability for motorcycle models at [www.puig.tv](http://www.puig.tv) typing in the searching window:  
**SPORT FOOTPEGS**

## SPORT

MODEL	REF.	A N O P R T V
SPORT FOOTPEGS BY PAIR (1)	7318	(*)
SPORT RUBBERS BY PAIR (SPARES)	7320N	(*)
VINTAGE FOOTPEGS BY PAIR (2)	9189	(*)
VINTAGE RUBBERS BY PAIR (SPARES)	9334H	(*)
ADAPTERS BY PAIR	<b>CHECK WEB</b>	
ADJUSTABLE HARDWARE SET	<b>CHECK WEB</b>	
RELOCATION BRACKETS SET 20 mm.	3838	(*)
RELOCATION BRACKETS SET 40 mm.	3839	(*)

(\*) Check price with your distributor.

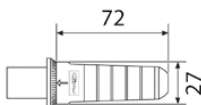

### DIMENSIONS

72 x 27 mm.



### DESIGN

Ergonomic increasing free height.



### REGULATION

On inclination.

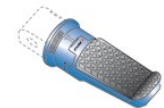

### PRECISE ADJUSTER

Add marks for proper regulation.

**NOTE:** to mount Puig footpegs, we use parts of oem footpegs.

**Footpegs for riders:** all models compatible.

**Footpegs for passanger:** all models compatible except trail and enduro footpegs.



# TRAIL 2.0 / ENDURO 2.0 FOOTPEGS

**TÜV****ABE**  
91553**TYP**  
FUR

**A** Blue  
**N** Black

**O** Gold  
**P** Silver

**R** Red  
**T** Orange

**V** Green

TRAIL 2.0  
ENDURO 2.0

**N** Rubber

REF. 208530

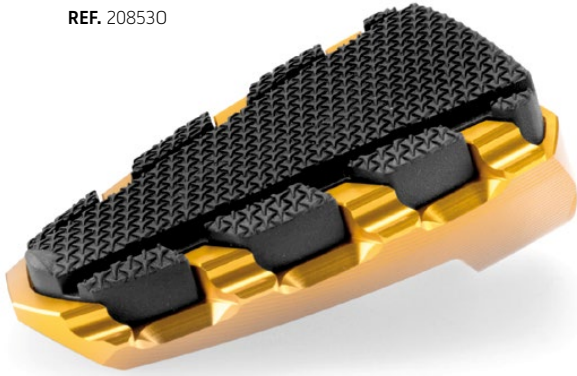

\* Check availability for motorcycle models at [www.puig.tv](http://www.puig.tv) typing in the searching window:

TRAIL2

## TRAIL 2.0

MODEL	REF.	A	N	O	P	R	T	V
TRAIL 2.0 WITH RUBBER FOOTPEGS BY PAIR	20853							(*)
ADAPTERS BY PAIR								<b>CHECK WEB</b>
ADJUSTABLE HARDWARE SET								<b>CHECK WEB</b>
TRAIL 2.0 RUBBERS BY PAIR (SPARES)	20854N							(*)
RELOCATION BRACKETS SET 20 mm.	3838							(*)
RELOCATION BRACKETS SET 40 mm.	3839							(*)

(\*) Check price with your distributor.



130gr.

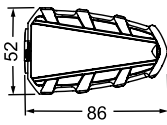

### DIMENSIONS

86 x 52 mm.

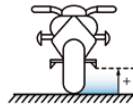

### DESIGN

Ergonomic increasing free height.

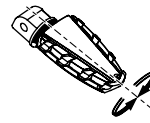

### REGULATION

On inclination.

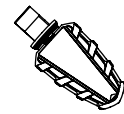

### PRECISE ADJUSTER

Add marks for proper regulation.

REF. 20851T



\* Check availability for motorcycle models at [www.puig.tv](http://www.puig.tv) typing in the searching window:

ENDURO2

## ENDURO 2.0

MODEL	REF.	A	N	O	P	R	T	V
ENDURO 2.0 WITH RUBBER FOOTPEGS BY PAIR	20851							(*)
ADAPTERS BY PAIR								<b>CHECK WEB</b>
ADJUSTABLE HARDWARE SET								<b>CHECK WEB</b>
ENDURO 2.0 RUBBERS BY PAIR (SPARES)	20852N							(*)
RELOCATION BRACKETS SET 20 mm.	3838							(*)
RELOCATION BRACKETS SET 40 mm.	3839							(*)

(\*) Check price with your distributor.



440gr.

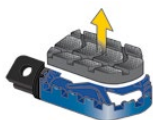

### WITH OR WITHOUT

The rubbers can be removed.

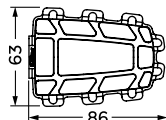

### DIMENSIONS

86 x 63 mm.

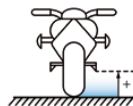

### DESIGN

Ergonomic increasing free height.

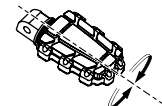

### REGULATION

On inclination.

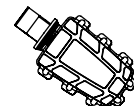

### PRECISE ADJUSTER

Add marks for proper regulation.

**NOTE:** to mount Puig footpegs, we use parts of oem footpegs.

**Footpegs for riders:** all models compatible.

**Footpegs for passenger:** all models compatible except trail and enduro footpegs.



# OFF-ROAD FOOTPEGS



\* Check availability for motorcycle models at [www.puig.tv](http://www.puig.tv) typing in the searching window:

**OFF-ROAD FOOTPEGS**

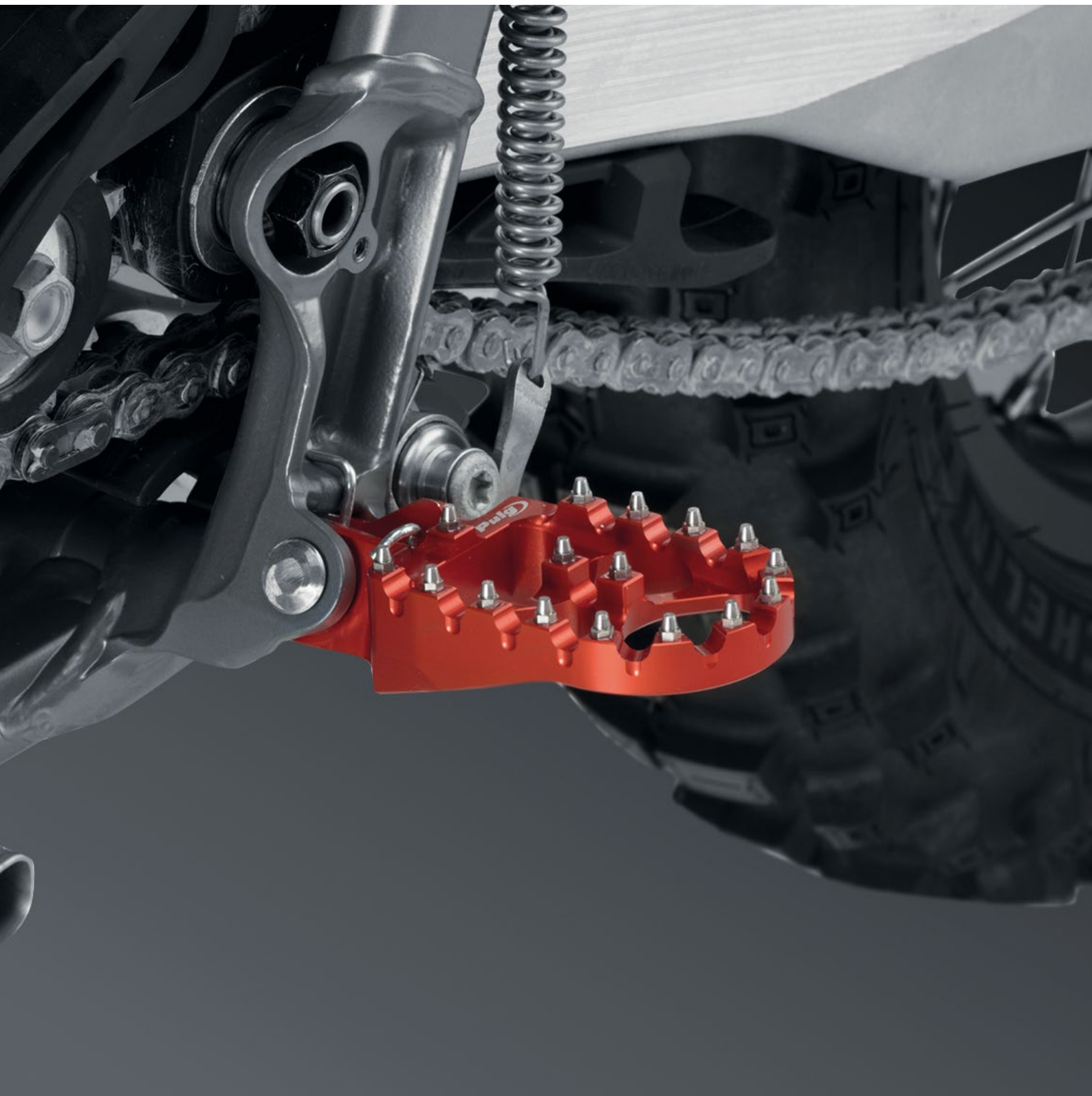

**A** Blue  
**N** Black

**O** Gold  
**P** Silver

**R** Red  
**T** Orange

**V** Green



REF. 20534V

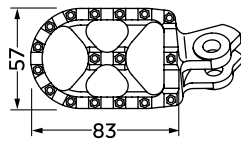

**DIMENSIONS**

83 x 57 mm.

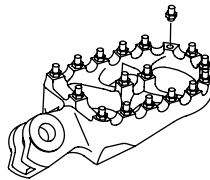

**DESIGN**

Maximum grip with replaceable tips.

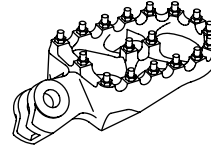

**MODEL**

A specific design for each bike.

**MODEL**

OFF-ROAD FOOTPEG SET WITH ADAPTORS

**REF.**

**A N O P R T V**

CHECK WEB

**SPARES**

REPLACEABLE TIPS

**REF.**

21573

**P**

(\*)

(\*) Check price with your distributor.

# HERITAGE FOOTPEGS



\* Check availability for motorcycle models at [www.puig.tv](http://www.puig.tv) typing in the searching window:

**HERITAGE FOOTPEGS**



**ABE**  
91553

**TYP**  
FUR



**KG**  
130gr.

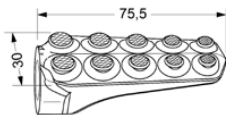

REF. 9980N

**DIMENSIONS**

75,5 x 30 mm.

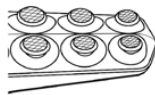
**DESIGN**Ergonomic increasing  
free height.**REGULATION**

On inclination.

**PRECISE ADJUSTER**Add marks for proper  
regulation.

MODEL	REF.	N
HERITAGE FOOTPEGS BY PAIR	9980	(*)
ADAPTERS BY PAIR		<b>CHECK WEB</b>
ADJUSTABLE HARDWARE SET		<b>CHECK WEB</b>
RELOCATION BRACKETS SET 20 mm.	3838	(*)
RELOCATION BRACKETS SET 24 mm.	3839	(*)

(\*) Check price with your distributor.

**NOTE:** to mount Puig footpegs, we use parts of oem footpegs.**Footpegs for riders:** all models compatible.**Footpegs for passanger:** all models compatible except trail and enduro footpegs.



# PLUG-OIL CAPS TRACK



\* Check availability for motorcycle models at [www.puig.tv](http://www.puig.tv) typing in the searching window:

**CAP TRACK**



**A** Blue  
**N** Black

**O** Gold  
**P** Silver

**R** Red  
**T** Orange

**V** Green



REF. 20342V



REF. 20340R

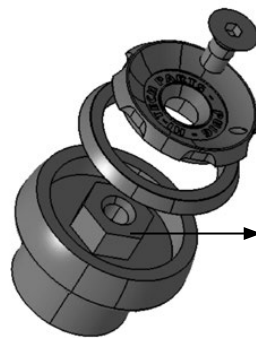

Tighten and loosen  
with 10 mm.  
Socket wrench.

**FIXATION**

Secure with allen wrench  
to prevent theft.

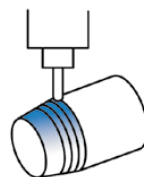
**MATERIAL**

Manufactured from  
billet aluminium.



# SPOOLS



\* Check availability for motorcycle models at [www.puig.tv](http://www.puig.tv) typing in the searching window:

**SPOOL**



## SPOOL / SPOOL PRO

 A Blue

 O Gold

 R Red

 N Black

 P Silver

 T Orange

 V Green

## SPOOL SLIDER

 N Black Nylon



**SPOOL PRO**

REF. 9259R



**SPOOL SLIDER**

REF. 4033N



**SPOOL**

REF. 59240

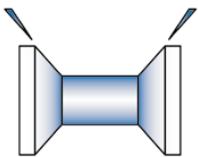

**FIXATION**

Fitting guide for stand support to lift up motorcycles quick and easy.

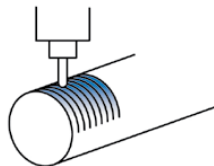

**MATERIAL**

Manufactured through billet aluminium and CNC machined to increase robustness.

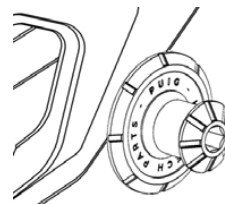

**PROTECTION**

The swing arm gets protected with the nylon washer added.

**DESIGN**

Spool and thread machined together to ease the assembly into the bike.



# KICKSTAND EXTENSION



\* Check availability for motorcycle models at [www.puig.tv](http://www.puig.tv) typing in the searching window:

**KICKSTAND**



Provide your motorcycle with greater stability and support surface while it is parked with the new kickstand extension from Puig.

Designed to prevent possible falls of the motorcycle while it is parked. This piece, with a 100% wider base than the original, allows parking on soft or uneven surfaces with greater safety. It is a mixed piece, with a part in stainless steel and the other machined from an aluminum block with rear anodizing.

These materials provide great resistance while maintaining a low weight (110-160g depending on the model). This product will prevent the motorcycle from suffering any setback when not in use.

**KG**  
90gr.



REF. 20193N



REF. 20805N



REF. 21234N



REF. 21280N



**DESIGN**

Kickstand larger base extension.

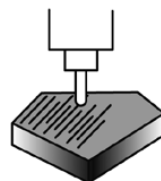

**CNC MACHINED**

Machined from billet aluminium and anodized in different colors.

# CHAIN TENSIONERS



\* Check availability for motorcycle models at [www.puig.tv](http://www.puig.tv) typing in the searching window:

**CHAIN TENSIONER**



**A** Blue  
**N** Black

**O** Gold  
**P** Silver

**R** Red  
**V** Green



REF. 20691R



REF. 20694P



REF. 21191V



REF. 20999N



REF. 206970

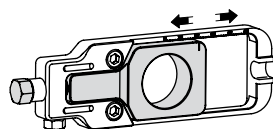

Effective regulation system and the marking on the upper part facilitates the chain tensioning operation.

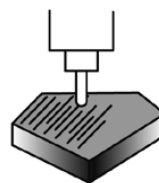

**CNC MACHINED**

Machined from billet aluminium and anodized in different colors.



# SHAFT COVER



\* Check availability for motorcycle models at [www.puig.tv](http://www.puig.tv) typing in the searching window:

**SHAFT COVER**



The Puig belt guard designed specifically for Yamaha T-Max. Available in black, it is made of anodized aluminum of 3 mm. thickness, which gives it the rigidity necessary to protect the driver and the passenger from possible friction, as well as the belt itself from possible blows produced by objects that are in the road. With this component, the maxiscooter has improved its security and at the same time personalizes its sporty and elegant image.

REF. 6336N



■ N Black

# CROWN COIL



\* Check availability for motorcycle models at [www.puig.tv](http://www.puig.tv) typing in the searching window.

**RING TRIM**



The crown ring by Puig reinforces the personality of the Japanese sports scooter, which gives it an outstanding point of differentiation compared to the oem.

Its minimalist design manufactured from billet aluminium, machined with technology and high precision machinery and has an anodized finish of great quality.

It is available in blue, gold, silver and red.

**A** Blue  
**D** Gold

**P** Silver  
**R** Red



REF. 7359R



# OIL-CARTER GUARD



\* Check availability for motorcycle models at [www.puig.tv](http://www.puig.tv) typing in the searching window:

**CARTER GUARD**

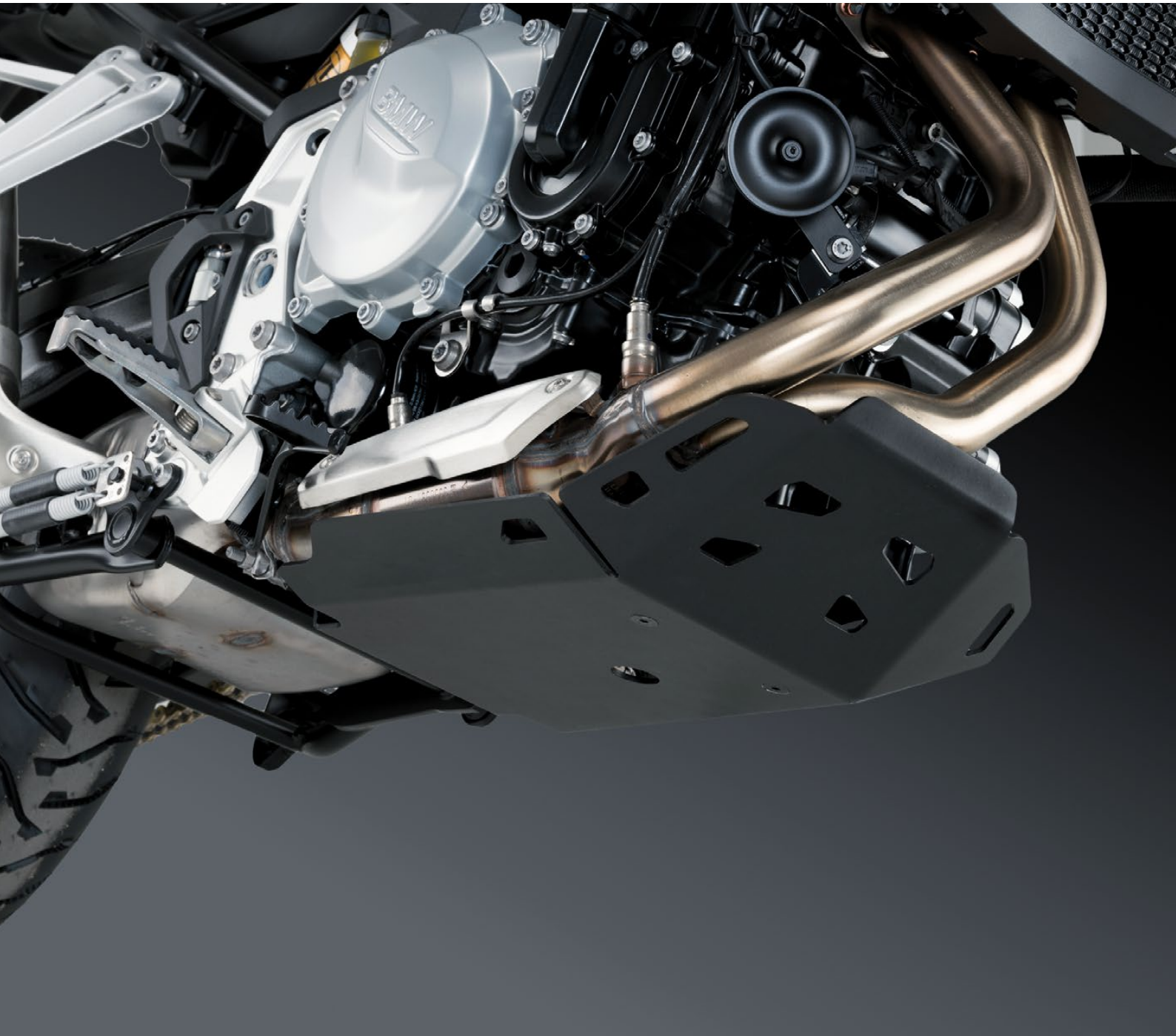

The lower part of the protector is completely flat, which makes it easier to lift the motorcycle from the lower part in the mechanical workshop if necessary, and it has holes to guarantee good cooling and to evacuate water, mud, or small accumulated stones. In addition to facilitating the oil change operation avoiding removing the protector.

The protector is fixed to the lower part of the motorcycle with anti-vibration rubber supports that absorb any possible blows that the protector may receive, distributing the impact force through the different fixing points and, in turn, eliminating possible annoying noises that exist when these rubbers are not being used.

P Silver

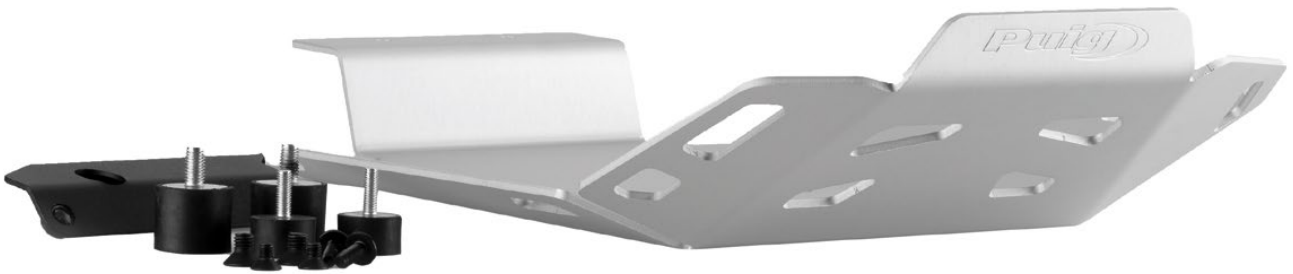
**NEW!**

REF. 21464P

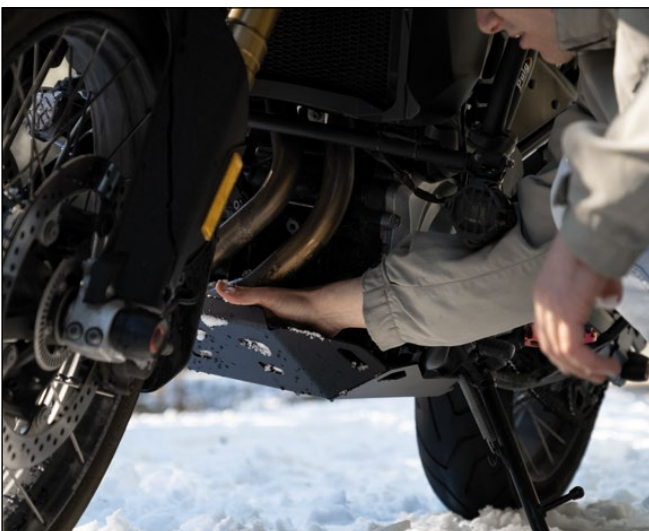

With its installation, valuable and sensitive areas are protected from receiving damage and impacts from stones and mud, such as the crankcase and the union of the headers, even more important if we take into account the Offroad possibilities offered by both models.

Manufactured in Barcelona, it is made of high-end 4 mm.-thick aluminum, resulting in a very resistant piece as well as light, and has a matt silver anodized finish.

It includes specific metal supports with anti-corrosion treatment painted in textured black for a discreet and elegant finish.



# ENGINE SPOILERS



\* Check availability for motorcycle models at [www.puig.tv](http://www.puig.tv) typing in the searching window.

**ENGINE SPOILER**



**ABE**  
30653

**TYP**  
BS

**ABS**



AERODYNAMIC

 C Carbon look

 J Matt black

 N Gloss Black



REF. 20428J



REF. 21327J

Protect one of the most sensitive parts of your bike with Puig engine spoilers.

Tested in the virtual wind tunnel to achieve a more aerodynamic volume and improvement in stability while riding, they protect the lower area of your bike from possible impacts, dirt, etc.

Manufactured with the highest technologies, its components are made of aluminum and/or ABS materials that are highly resistant to impacts and UV rays, in turn they are light and durable. The plastic parts have a built-in surface treatment that improves the behavior against chemical agents and in turn also offers total protection against UV rays.

This layer avoids the need to have to paint the engine spoiler. The metal supports are made of 2 mm. metal, with anti-corrosion treatment, resistant and easy to install. In addition to protecting the motorcycle, Puig engine spoilers are designed to give your bike a more sporty character, so most models come with a sticker kit to customize them. You can find these engine spoilers in two finishes: black or carbon-like.

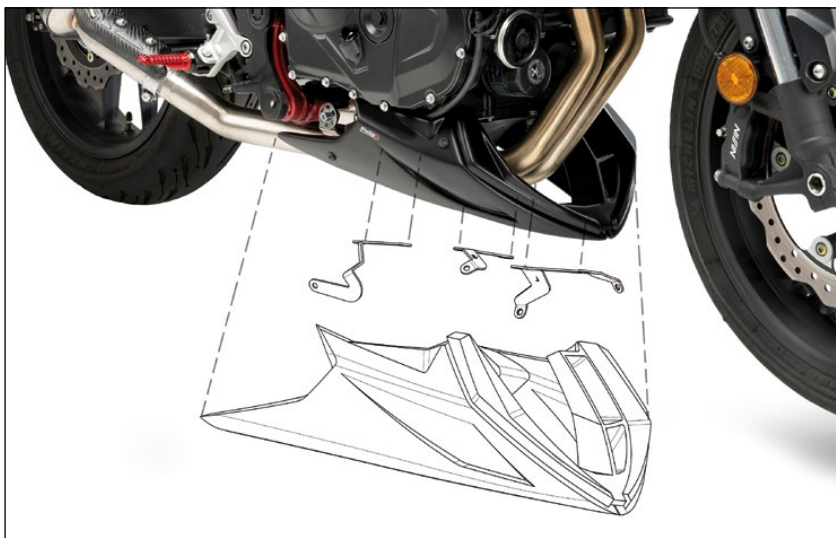

Easy assembly - 15 minutes.

No modifications required.

Check compatibility with other exhaust pipes.



# FRAME SLIDERS PRO 2.0



\* Check availability for motorcycle models at [www.puig.tv](http://www.puig.tv) typing in the searching window:

**PRO 2.0**



## BODY

**N** Black

## RUBBER END

**A** Blue

**R** Red

**U** Grey

**V** Green

REF. 21217N + 20872U

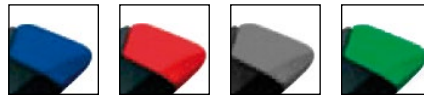
**RUBBER END**

Available in different colors.

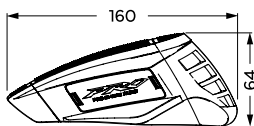
**DIMENSIONS**

160 X 64 mm.

**PROTECTION**

Front and rear protection with flexible zones.

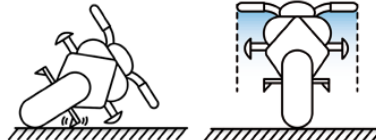
**DESIGN**

Sliders do not stand out from handlebar and touch after the footpegs.

**COMPLETE PROTECTION**

Protect engine and chassis.

**SPARES**

	REF.	ARUV	N
SET OF RUBBER SECTIONS REAR/FRONT & RIGHT/LEFT (4 PARTS) C/BLUE	20872	(*)	
SET OF RUBBER SECTIONS REAR/FRONT & RIGHT/LEFT (4 PARTS) C/GREY	20872	(*)	
SET OF RUBBER SECTIONS REAR/FRONT & RIGHT/LEFT (4 PARTS) C/RED	20872	(*)	
SET OF RUBBER SECTIONS REAR/FRONT & RIGHT/LEFT (4 PARTS) C/GREEN	20872	(*)	
LID SET WITH LOGO PRO 2.0 C/BLACK	20873		(*)
SET OF NYLONS + FRONT AND REAR RUBBER ENDS + SET OF COVERS WITH LOGO FOR M10 SCREW C/BLACK	20874		(*)
SET OF NYLONS + FRONT AND REAR RUBBER ENDS + SET OF COVERS WITH LOGO FOR M12 SCREW C/BLACK	20875		(*)

(\*) Check price with your distributor.



# FRAME SLIDERS R19



\* Check availability for motorcycle models at [www.puig.tv](http://www.puig.tv) typing in the searching window:

**R19**

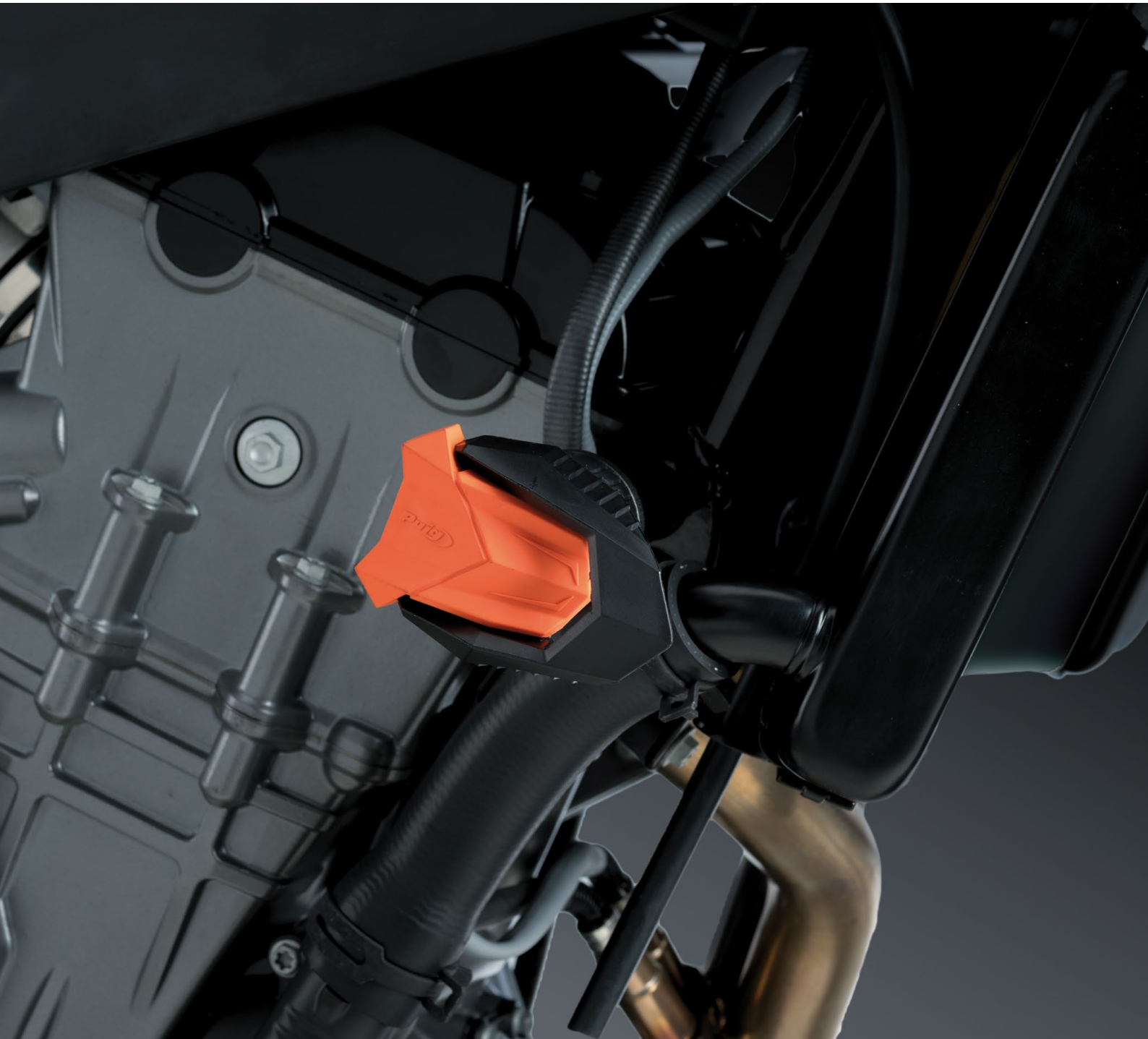

Lower dimensions to achieve better integration into the aesthetics of the motorcycle. The reduction in measurements entails a lower protection of the engine block, for which we recommend the joint assembly of the engine cover protector kit. Available only for some specific models.

## BODY

 N Black

## RUBBER END

 A Blue

 B White

 N Black

 R Red

 T Orange

 U Grey

 V Green



Our Beam and Beam 2.0 auxiliary headlights can be mounted on the R19 frame slider.

**BODY**

Nylon pucks in black colour.

REF. 21240N



RUBBER ENDS AVAILABLE IN VARIOUS COLORS

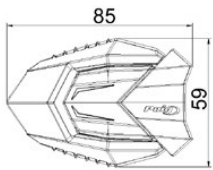

**DIMENSIONS**

85 X 59 mm.



**RUBBER**

Protects rider's knee from possible hits while getting on the bike. Supplied in grey color.

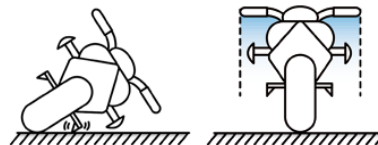

**DESIGN**

Sliders do not stand out from handlebar and touch after the footpegs.



**COMPLETE PROTECTION**

Protect engine and chassis.

**SPARES GOMAS**

	REF.	ABNRTUV
RUBBER END PROTECTOR R19 BY PAIR	3148	(*)

**SPARES TOPES**

	REF.	N
NYLON PUCKS + RUBBER END C/GREY BY PAIR MOD. R19 OF 85 mm. FOR SCREW M10	3149	(*)
NYLON PUCKS + RUBBER END C/GREY BY PAIR MOD. R19 OF 85 mm. FOR SCREW M12	3150	(*)
NYLON PUCKS + RUBBER END C/GREY BY PAIR MOD. R19 OF 50 mm. FOR SCREW M10	3151	(*)
NYLON PUCKS + RUBBER END C/GREY BY PAIR MOD. R19 OF 50 mm. FOR SCREW M12	3152	(*)

**SPARES**

	REF.	ABRUV	N
NYLON PUCK VINTAGE 2.0 FOR M10 BOLT (COMPATIBLE WITH R19 PUCKS)	3153		(*)
NYLON PUCK VINTAGE 2.0 FOR M12 BOLT (COMPATIBLE WITH R19 PUCKS)	3154		(*)
RUBBER END PROTECTOR VINTAGE 2.0 BY PAIR	3667	(*)	

(\*) Check price with your distributor.

# FRAME SLIDERS VINTAGE 2.0



\* Check availability for motorcycle models at [www.puig.tv](http://www.puig.tv) typing in the searching window:

**VINTAGE**

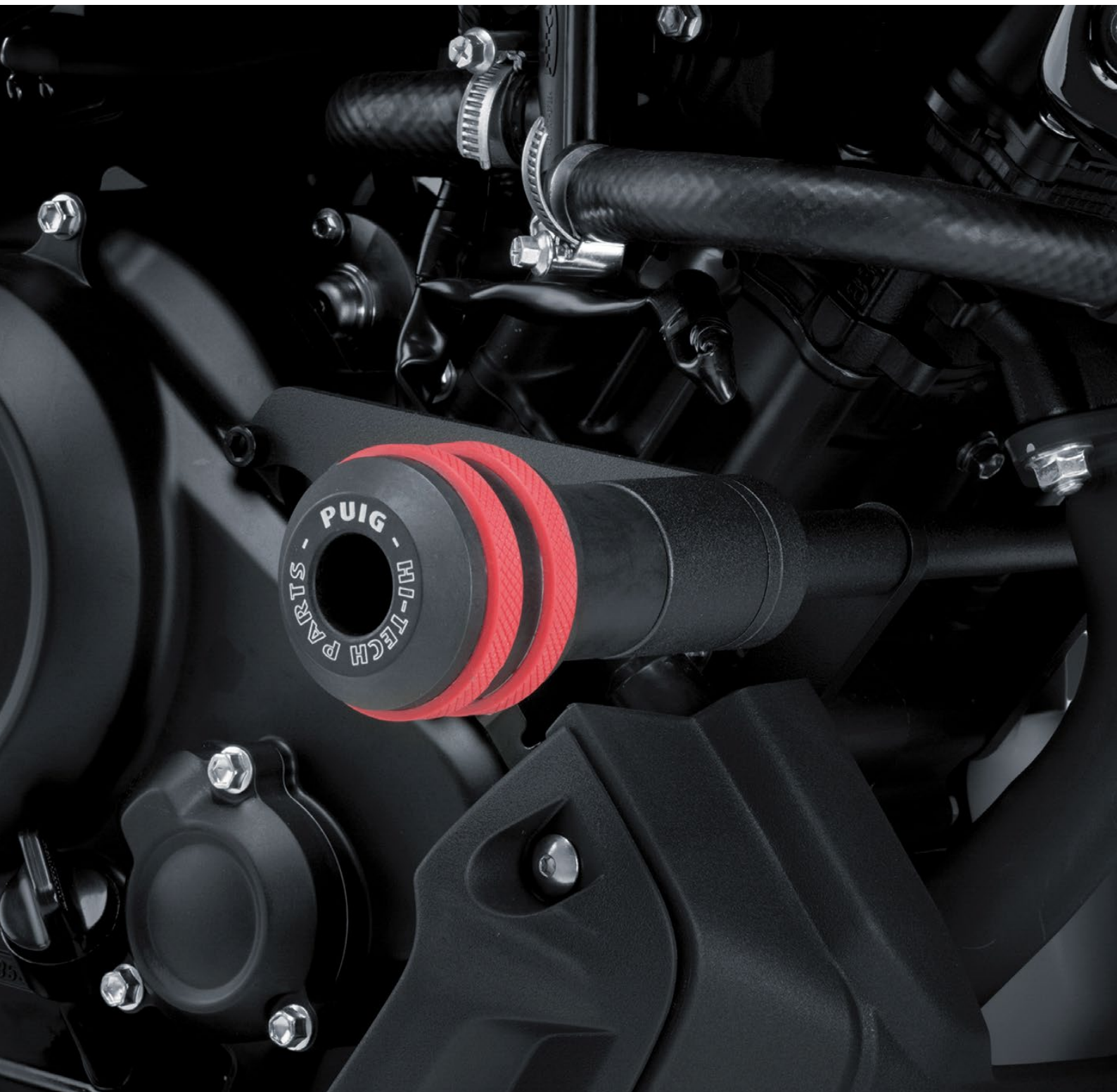

## BODY

**N** Black

## RUBBER END

**A** Blue

**B** White

**R** Red

**U** Grey

**V** Green



REF. 20390N + 3667A

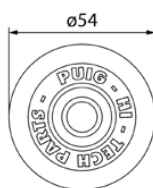

RUBBER ENDS AVAILABLE IN VARIOUS COLORS

**DIMENSIONS**

Ø54 mm.

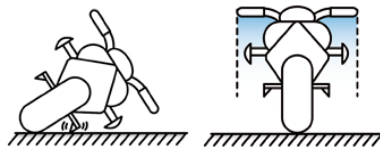
**DESIGN**

Sliders do not stand out from handlebar and touch after the footpegs.

**COMPLETE PROTECTION**

Protect engine and chassis.

**SPARES**

	<b>REF.</b>	<b>ABRUV</b>	<b>N</b>
NYLON PUCK FOR M10 BOLT (COMPATIBLE WITH R19 PUCKS)	3153		(*)
NYLON PUCK FOR M12 BOLT (COMPATIBLE WITH R19 PUCKS)	3154		(*)
RUBBER END PROTECTOR VINTAGE 2.0 BY PAIR	3667	(*)	

(\*) Check price with your distributor.

Its double section and central grooves give it a slimmer appearance without losing muscle. The optional incorporation of rubber rings has a double function: they protect the rider from possible impacts and allow the protector to be personalized with its range of colors.



# ENGINE GUARDS



\* Check availability for motorcycle models at [www.puig.tv](http://www.puig.tv) typing in the searching window:

**ENGINE GUARD**



-  N Black
-  U Grey

REF. 21192



Made of steel using high quality machining and precision welds for a perfect fit.

Perfect complement for Trail or Naked type motorcycles, in which the absence of a fairing makes them especially vulnerable to blows in the event of a fall. Improvement in safety and rigidity, in addition to receiving an aesthetic complement that reinforces its image and gives a greater sensation of robustness.



Our Beam, Beam 2.0 and Beam 3.0 auxiliary headlights can be mounted on our engine guards.



# ENGINE PROTECTIVE COVERS



\* Check availability for motorcycle models at [www.puig.tv](http://www.puig.tv) typing in the searching window:

**ENGINE COVER**



Manufactured in 4 mm. thick polypropylene for strength, durability and good appearance. The covers are simply bolt-on on the oem engine case.

Compact for a maximum distance to the ground, matt finished, and protecting one of the most vulnerable areas of the machine.

REF. 20221N



REF. 20289N



# APPROVED ENGINE COVER PROTECTOR KIT



\* Check availability for motorcycle models at [www.puig.tv](http://www.puig.tv) typing in the searching window:

**ENGINE COVER**

## NEW!



Made of 4 mm. polypropylene that provide great resistance to impacts and abrasion, as well as offering the maximum possible lightness.

With its installation, the most exposed parts of the engine are protected in case of falls and dragging.

**Caps with wear warning approved by the International Motorcycle Federation (FIM). Suitable for professional riding.**

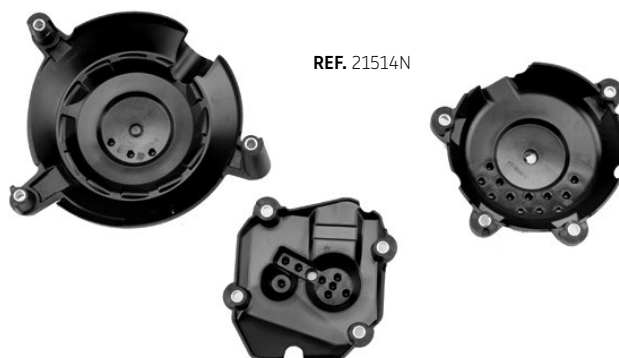

REF. 21514N

■ N Black



# ALUMINIUM FILTER COVER, CLUTCH COVER AND SPROCKET COVER

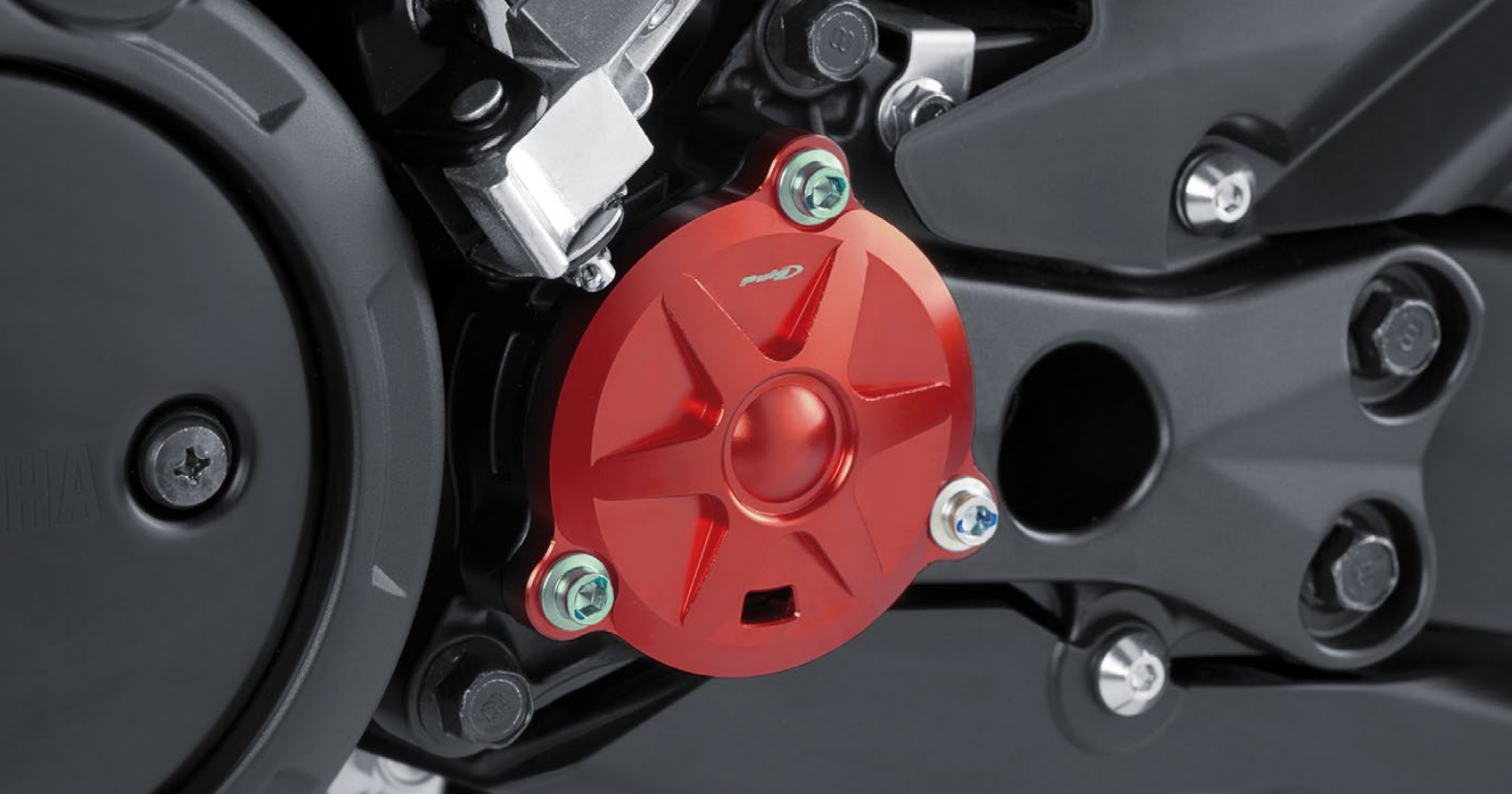

**A** Blue  
**N** Black

**O** Gold  
**P** Silver

**R** Red

REF. 9993N



## ALUMINIUM FILTER COVER



\* Check availability for motorcycle models at [www.puig.tv](http://www.puig.tv) typing in the searching window:

**FILTER COVER**

REF. 9855N



## CLUTCH COVER



\* Check availability for motorcycle models at [www.puig.tv](http://www.puig.tv) typing in the searching window:

**CLUTCH**

REF. 85020



## SPROCKET COVER



\* Check availability for motorcycle models at [www.puig.tv](http://www.puig.tv) typing in the searching window:

**SUMP**



# CHASSIS CAP COVERS



\* Check availability for motorcycle models at [www.puig.tv](http://www.puig.tv) typing in the searching window:

**CHASSIS PLUGS**

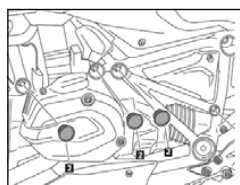

## 2 FUNCTIONALITIES

Cover hollow areas of the chassis and improves look of the bike.



REF. 9332-9333

 N Black



# ALUMINIUM CHASSIS COVERS



\* Check availability for motorcycle models at [www.puig.tv](http://www.puig.tv) typing in the searching window.

**ALU CHASSIS PLUGS**

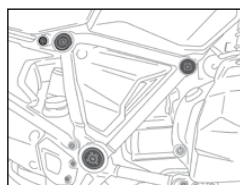

## 2 FUNCTIONALITIES

Cover hollow areas of the chassis and improves look of the bike.

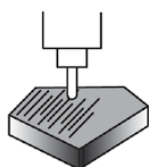

## CNC MACHINED

Machined from billet aluminium and anodized in different colors.



REF. 214320

**A** Blue  
**N** Black

**O** Gold  
**P** Silver

**R** Red



# SIDE PANELS



\* Check availability for motorcycle models at [www.puig.tv](http://www.puig.tv) typing in the searching window:

**PANELS**



**ABS**

 C Carbon look

 N Black

 J Matt black

 P Aluminium

 U Grey



**1. REF. 9590P**  
**MATERIAL:** Aluminium



**2. REF. 8562J**  
**MATERIAL:** ABS

## RETRO SIDE PANELS

MODEL	REF.	J	C	P
<b>UNIVERSAL</b>				
PLASTICS UNIVERSAL SIDE COVERS WITHOUT FITTINGS	9232	(*)	(*)	
UNIVERSAL ALUMINUM SIDE COVERS WITHOUT FITTINGS	9599			(*)

(\*) Check price with your distributor.



REF. 3596J

## SIDE PANELS

SPARES	REF.	J
R1200GS SIDE COVERS	9234	(*)

(\*) Check price with your distributor.



**CLEAN**  
 Protect the rider and motorcycle from dirt on all type of roads.



**DESIGN**  
 Covers empty areas of the motorcycles.



# REAR DEFLECTORS



\* Check availability for motorcycle models at [www.puig.tv](http://www.puig.tv) typing in the searching window:

**DEFLECTORS**

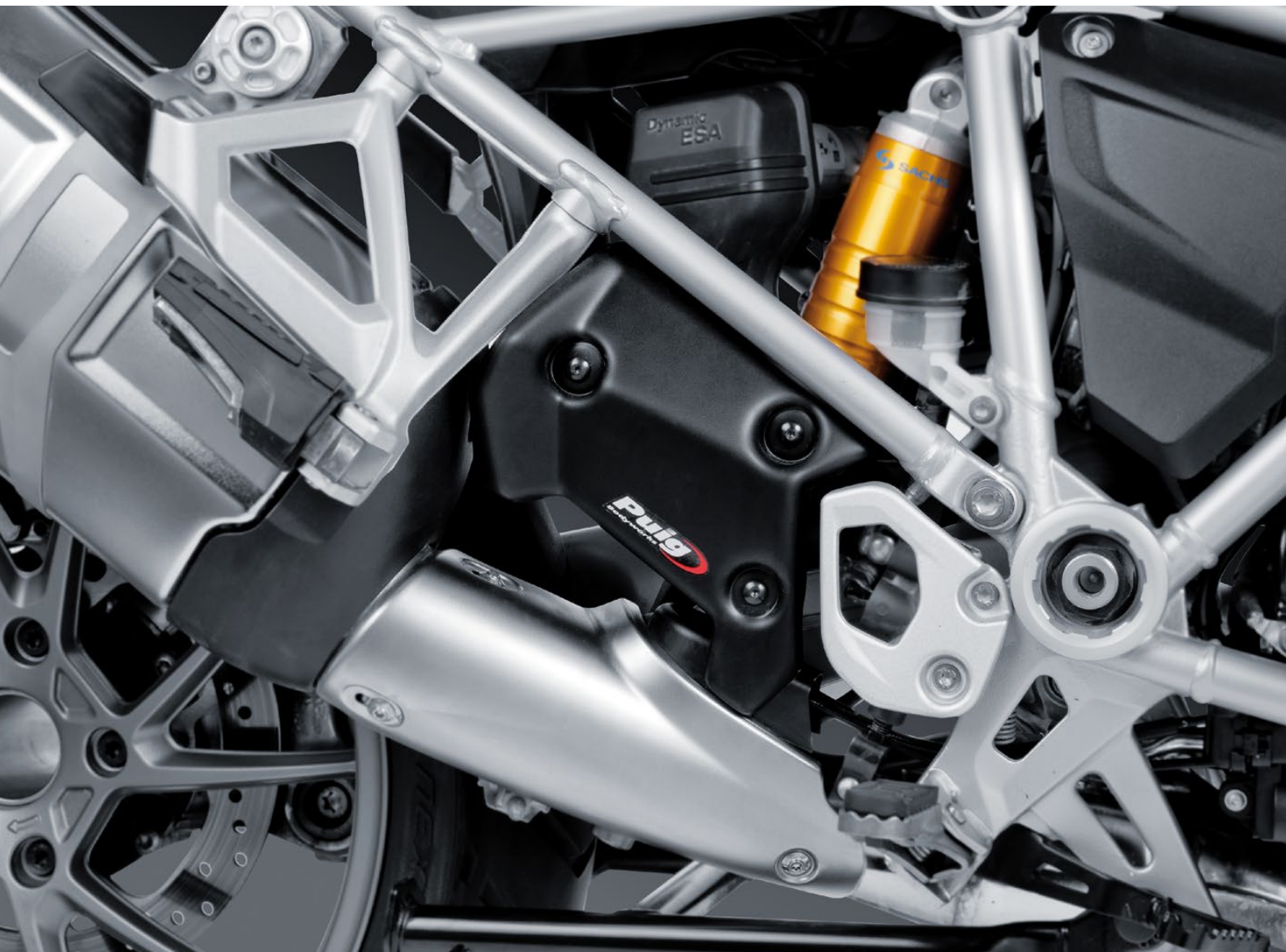

## ABS

Manufactured in ABS material, highly resistant to impacts and with great aerodynamic capacity, it will allow you to improve the condition of your bike during the ride before the wind, as well as enhancing the aesthetic image while you cover hollow areas of the motorcycle. Designed exclusively for BMW specific models.

The piece is available in different colors depending on the BMW model that you have and installation will not be a problem since it comes with Puig's classic visual instructions.

 C Carbon look

 J Matt black

 U Grey



REF. 6869J

# EXHAUST PROTECTOR - DEFLECTOR



\* Check availability for motorcycle models at [www.puig.tv](http://www.puig.tv) typing in the searching window:

**DEFLECTORS**

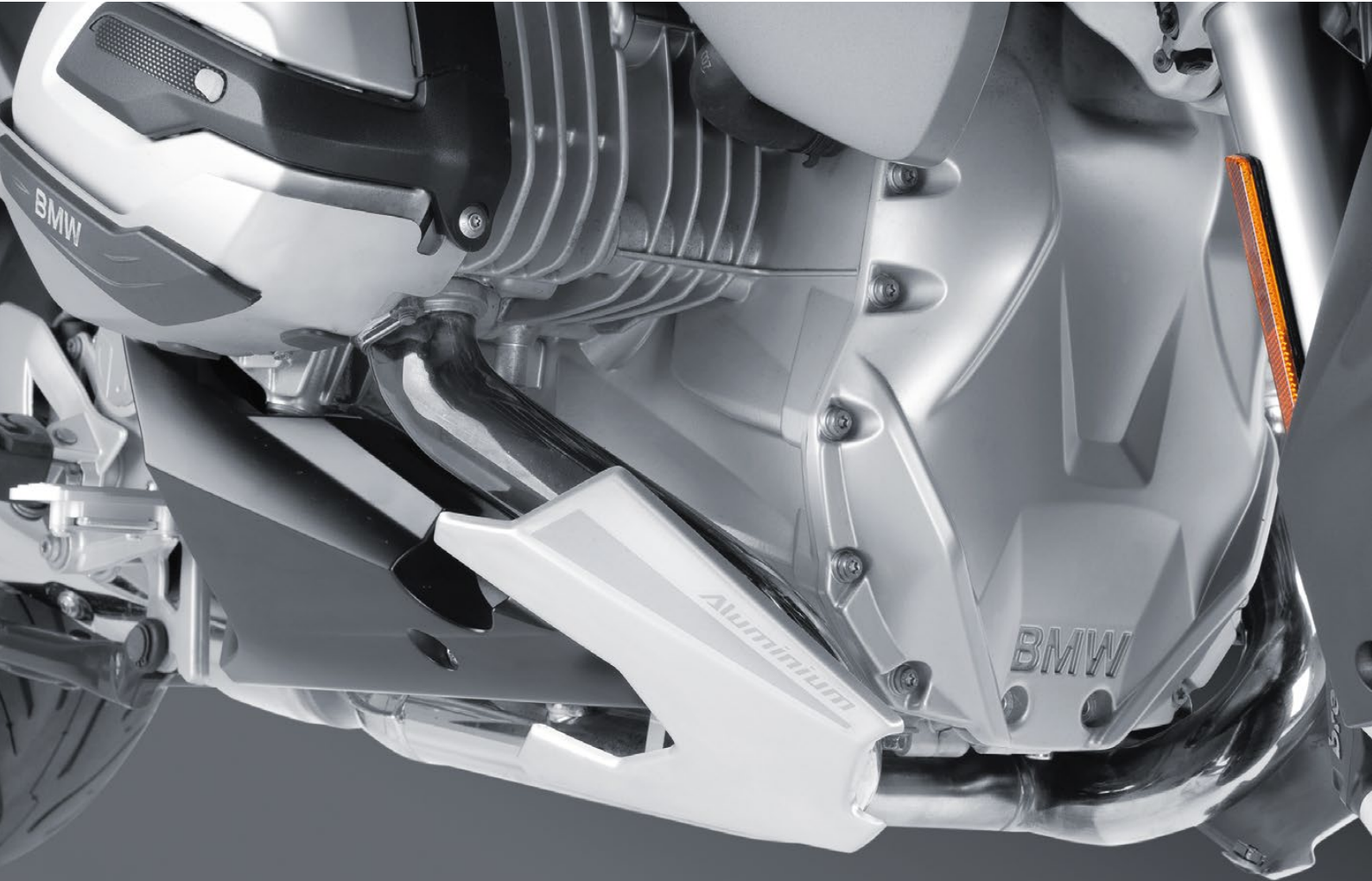

**ALU**

The exhaust manifolds of the BMW R 1200 RT are safe with the deflector-protector of escape from Puig.

This piece of the Hi-Tech Parts catalog fulfills a visible decorative and personalization function for the German tourer, but above all it is an element with an important functional mission, since it protects the exhaust of possible blows that may deteriorate it and affect the performance of the motorcycle.

Made of aluminum, its precise design allows it to adapt perfectly to the lower part of this BMW, the area most exposed to gravel impacts or other objects on the road.

P Silver



REF. 8546P  
**ALUMINIUM  
BASE**



# 7

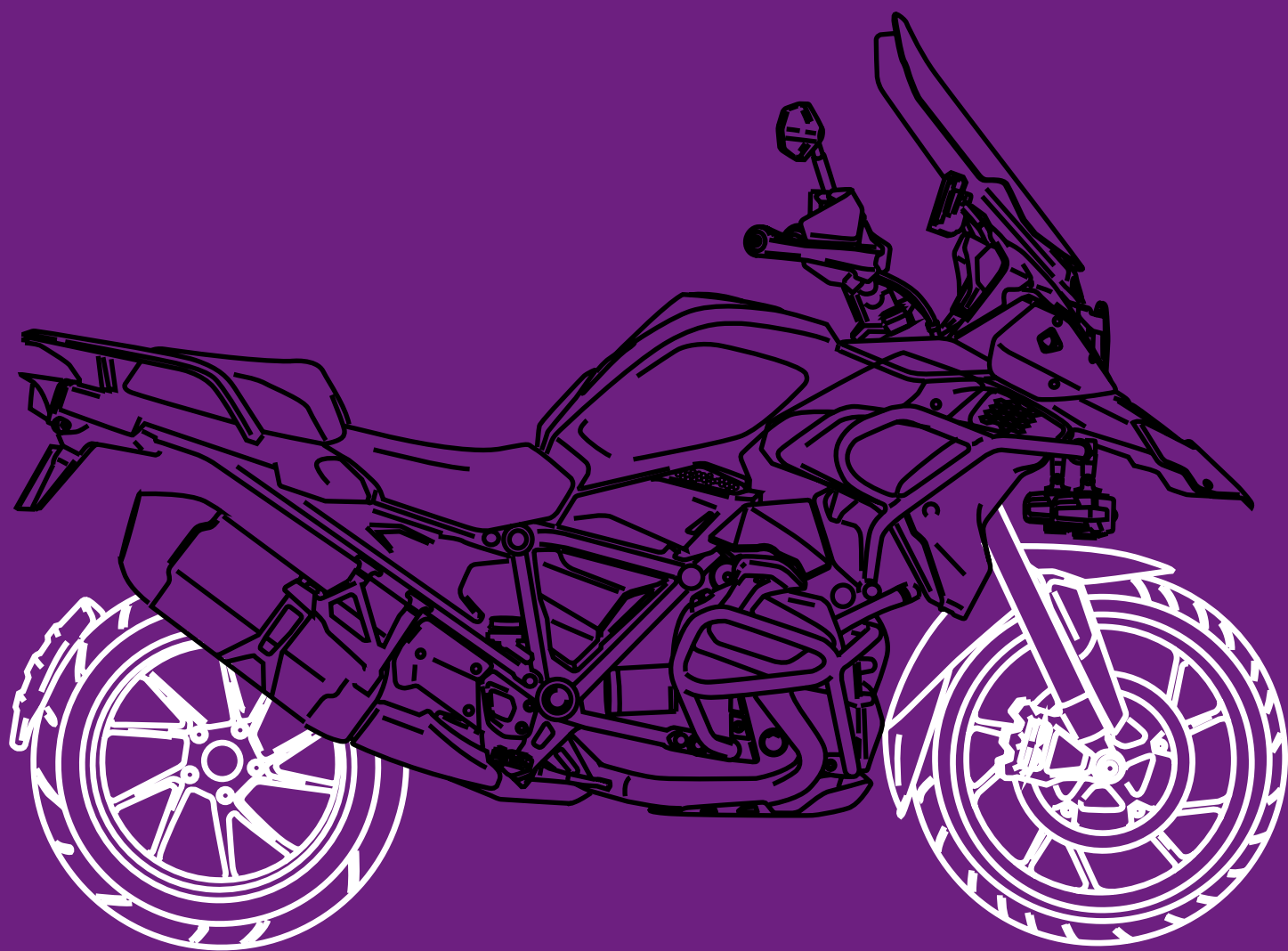

# WHEELS AREA

ADHESIVE KIT FOR BMW CASES	466
ADHESIVE STRIPS	456
ADHESIVE STRIPS PREMIUM	458
AXLE SLIDERS PHB19	452
BRAKE COOLERS	438
FRONT FENDER	448
FRONT FENDER EXTENSION	450
PERFORMANCE ARC STRIPS	460
REAR FENDER EXTENSION	442
REAR FENDER FOR LICENSE PLATE	446
REAR FENDERS	440
RIM STRIPS GS	464
SINGLE-SIDED REAR FENDER	444
SPECIAL RIM STRIPS	462
STAND SUPPORTS	468
SWING ARM PROTECTOR GS	465
TENSORS FOR REAR WHEEL BY PAIR	455
VALVES	454

# BRAKE COOLERS



\* Check availability for motorcycle models at [www.puig.tv](http://www.puig.tv) typing in the searching window:

**BRAKE COOLER**



**ABS**

**METALIC  
MADE**



**AERODYNAMIC**

**N Black**



The brake cooler has been designed taking into account the high performance offered by sports riding, in which its effective set of brakes is pushed to the limit, with strong and continuous braking like those on the circuit, and even more so in the hot months.

This can cause overheating that reduces performance and braking sensations. It is made up of two high-end ABS plastic covers, one for each disc and caliper assembly, creating a channel that captures the air and compacts and accelerates it to direct it directly on the pads and the brake disc, managing to lower the temperature of the brakes by ten degrees on average as has been verified in race track tests, which allows them not to overheat and work optimally.

Its studied design, in addition to providing a more sporty and personalized aesthetic, eliminates turbulence at the front wheel by creating a partial lenticular cover that favors the motorcycle's aerodynamics, especially at high speeds. Includes sturdy, lightweight aluminum brackets finished in discreet textured black.



Our brake cooler offers greater air channeling by having a larger intake mouth than the competition. Totally different aesthetic. At the same time, it improves aerodynamics by converting part of the front wheel into a lenticular one. Contrasted effectiveness.



# REAR FENDERS



\* Check availability for motorcycle models at [www.puig.tv](http://www.puig.tv) typing in the searching window.

**MUDGUARD**



 C Carbon look

 J Matt black

Specific vanguard design for each bike, combined with the maximum protection against inclement weather.

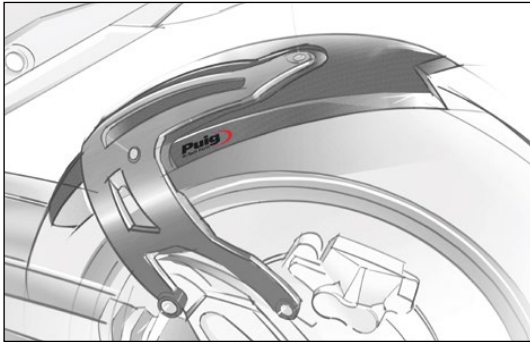

**BMW R1200R 15'-18' (REF. 7682)**

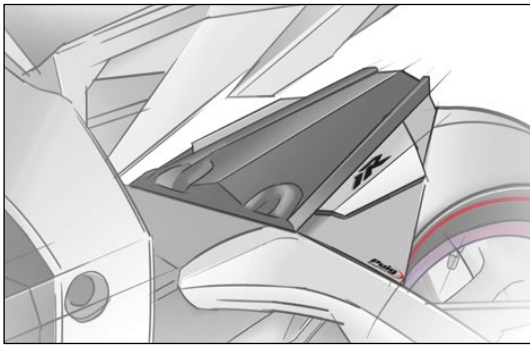

**YAMAHA YZF-R1 15'-19' (REF. 7688))**



**REF. 9464J**

**FENDER  
WITH ALUMINIUM SUPPORT**

Support made of injected aluminium.



**REF. 20544C**

**FENDER S**

Maximum protection with a specific vanguard design.



**REF. 20488J**

**FENDER R**

Racing look with stainless steel detail.

# REAR FENDER EXTENSION



\* Check availability for motorcycle models at [www.puig.tv](http://www.puig.tv) typing in the searching window:

**REAR FENDER**



**ABS**

**J Matt black**





REF. 9902J



REF. 21158J



REF. 21161J

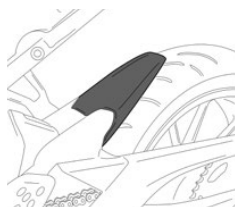

REF. 9911J

**FUNCTIONAL**

It improves the protection of the original fender.

**MATERIAL**

Manufactured in ABS material.  
It attaches through adhesive 3M and mechanical processes and plastic rivets.



# SINGLE-SIDED REAR FENDER



\* Check availability for motorcycle models at [www.puig.tv](http://www.puig.tv) typing in the searching window:

**SINGLE SWING ARM**



TÜV

ABE  
31060

ABS

METALIC  
MADE

● J Matt black



REF. 20397J

The main objective of the single swing arm fender is to provide extra protection against splashes of water, mud and stones.

**FUNCTIONAL**

Protects the motorcycle and the rider from water, mud and small rocks.

**MATERIAL**

Fender made of ABS.

**MATERIAL**

Manufactured from machined aluminium with chamfered edge.

**ADJUSTABLE**

Dimmable and adjustable.

**WEIGHT**

Light and resistant. Manufactured in aluminium.

# REAR FENDER FOR LICENSE PLATE



\* Check availability for motorcycle models at [www.puig.tv](http://www.puig.tv) typing in the searching window:

**REAR FENDER EXTENDER**



**ABS**

**N** Black

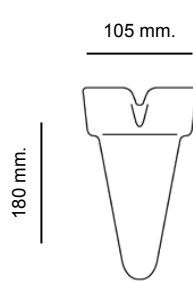

## URBAN UNIVERSAL

MODEL	REF.	N
URBAN UNIVERSAL	6413	(*)

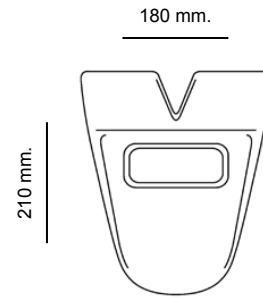

## TOUR UNIVERSAL

MODEL	REF.	N
TOUR UNIVERSAL	6412	(*)

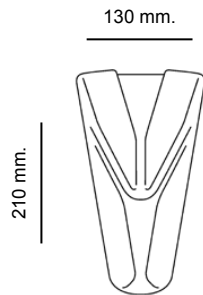

## URBAN HONDA

MODEL	REF.	N
URBAN HONDA NC700X/S - INTEGRA	6428	(*)

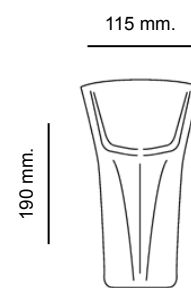

## TOUR YAMAHA

MODEL	REF.	N
TOUR YAMAHA	6427	(*)

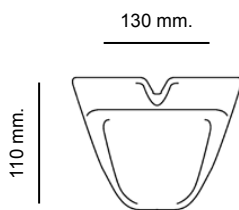

## SPORT UNIVERSAL

MODEL	REF.	N
SPORT UNIVERSAL	6414	(*)

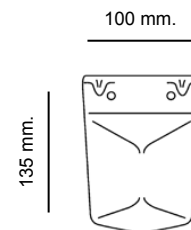

## TOUR DUCATI

MODEL	REF.	N
TOUR DUCATI	6675	(*)

(\*) Check price with your distributor.

**NOTE:** manufactured in abs plastic.

Fixed with screws or 3M adhesive.



# FRONT FENDER



\* Check availability for motorcycle models at [www.puig.tv](http://www.puig.tv) typing in the searching window:

**FRONT FENDER**





REF. 9992N

Their surfaces are machined from billet aluminium, indicated by the surface texture and exclusive finish to this method of work.

They are finally anodized in two colors, black for the mudguard and silver for the supports, which gives a touch of elegance to the piece.



REF. 3688N

Made out of a 1,2 mm. thick aluminum sheet, lightweight yet durable with its milled supports and a beautiful yet simple finish, all according to the lines of your bike.

It retains the original anchor points so that it is easily interchangeable with the original and fits snugly against the motorcycle's attachment points.

Supplied with the necessary parts for installation and detailed step-by-step installation instructions, no mechanical knowledge or previous experience is required to install it.

**NOTE:** fitting kit in steel.

# FRONT FENDER EXTENSION



\* Check availability for motorcycle models at [www.puig.tv](http://www.puig.tv) typing in the searching window:

**FRONT FENDER**



**ABS**

**N** Black





REF. 5786N



REF. 3895N



REF. 3901N

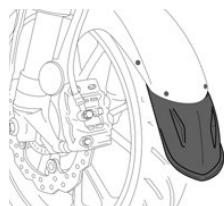

REF. 9202N

**FUNCTIONAL**

It improves the protection of the original fender.

**MATERIAL**

Manufactured in ABS material.  
It attaches through adhesive 3M and mechanical processes and plastic rivets.



# AXLE SLIDERS PHB19



\* Check availability for motorcycle models at [www.puig.tv](http://www.puig.tv) typing in the searching window:

**PHB19**



## BODY

 N Black

## ALUMINUM RINGS

 A Blue  
 N Black

 O Gold  
 P Silver

 R Red  
 T Orange

 V Green



REF. 20279N



The set of anodized aluminium rings must be ordered separately from the sliders, depending on the color of the bike.

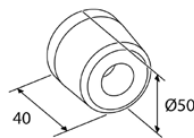

**DIMENSIONS**



**DESIGN**

Racing look for your motorcycle.

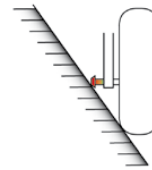

**COMPLETE PROTECTION**

Fork and swing arm protection.

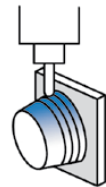

**MATERIAL**

Fork and swing arm protection.

**AXLE SLIDERS**

	REF.	N
UNIVERSAL	20097	(*)

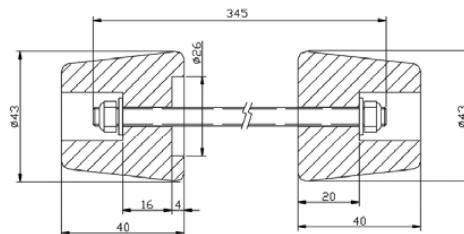

REF. 20097N

**SPARES**

	REF.	N	ANOPRTV
NYLON MOD. UNIVERSAL RIGHT SIDE	20098	(*)	
NYLON MOD. UNIVERSAL LEFT SIDE	20099	(*)	
ANODIZED ALUMINIUM RING SET FOR FORK PROTECTION	20025		(*)
ANODIZED ALUMINIUM RING SET FOR SWING ARM PROTECTION	20271		(*)

(\*) Check price with your distributor.



# VALVES



\* Check availability for motorcycle models at [www.puig.tv](http://www.puig.tv) typing in the searching window:

**VALVE**



8gr.

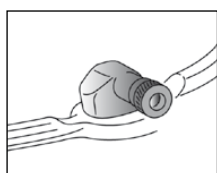
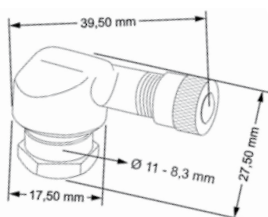

## DESIGN

Manufactured through billet aluminium.

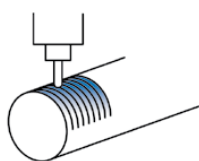

## MATERIAL

Developed to ease the inflation process.

REF. 5591V



MODEL	Ø WHEEL HOLE	REF.	A G N P R T V
UNIVERSAL BY PAIR	11 mm.	5591	(*)
UNIVERSAL BY PAIR	8,3 mm.	8100	(*)

\* Not compatible with motorcycles with inner tubes.

\* Not compatible with motorcycles with a pressure gauge.

**A** Blue  
**G** Yellow

**N** Black  
**P** Silver

**R** Red  
**T** Orange

**V** Green

(\*) Check price with your distributor.

# TENSORS FOR REAR WHEEL BY PAIR



\* Check availability for motorcycle models at [www.puig.tv](http://www.puig.tv) typing in the searching window:

**TENSORS WHEEL**



The set of tensioners for the Yamaha T-Max rear wheel by Puig allow you to precisely adjust the belt of the best-selling Japanese scooter. They are manufactured in aluminum and are machined with a graduated measuring scale, which allows to correct with precision the tension of the transmission belt

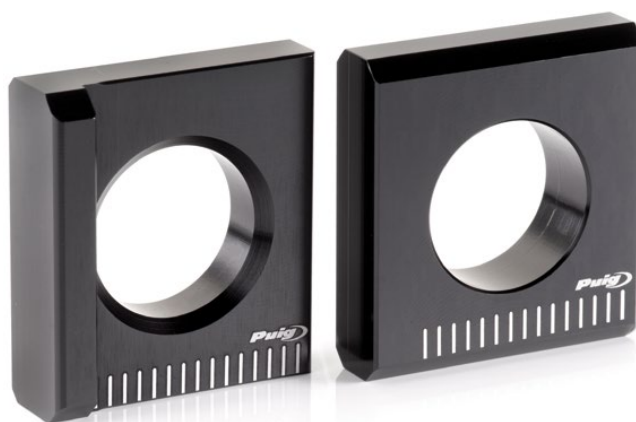

REF. 7357N



# ADHESIVE STRIPS



\* Check availability for motorcycle models at [www.puig.tv](http://www.puig.tv) typing in the searching window:

**STRIPS**



**A** Blue  
**B / M** White  
**C** Carbon look

**G / O** Yellow  
**L** Violet  
**N** Black

**Z** Oro  
**P** Silver  
**Q** Pink

**R** Red  
**T / X** Orange  
**V** Green



**A - BLUE REFLECTIVE**



**B - WHITE REFLECTIVE**



**M - PURE WHITE**



**C - CARBON LOOK**



**G - YELLOW FLUORESCENT**



**O - YELLOW REFLECTIVE**



**L - PURPLE**



**N - MATT BLACK**



**Z - GOLD**



**P - SILVER**



**Q - PINK**

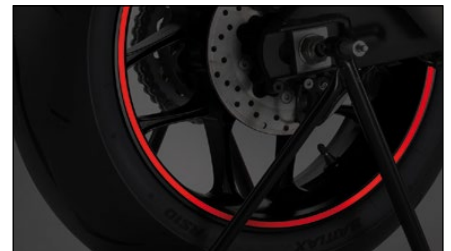

**R - RED REFLECTIVE**



**T - ORANGE FLUORESCENT**

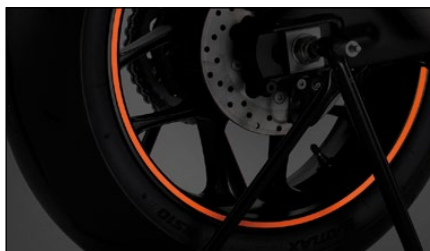

**X - ORANGE REFLECTIVE**



**V - GREEN FLUORESCENT**

MODEL	REF.	ABMCGOLNZPQRTXV
STRIP WITHOUT APLICATOR	2568	(*)
STRIP WITH APLICATOR	4542	(*)

(\*) Check price with your distributor.

**NOTE:** strip size 7 mm. Width x 6 m. Length. To be applied on the wheel from 16" to 18".



# ADHESIVE STRIPS PREMIUM



\* Check availability for motorcycle models at [www.puig.tv](http://www.puig.tv) typing in the searching window:

**STRIPS**



**A** Blue  
**B** White

**G** Yellow  
**R** Red

**T** Orange  
**V** Green



## BLUE FLUORINE

MODEL	REF.	A
BLUE FLUORINE	8431A	(*)



## WHITE FLUORINE

MODEL	REF.	B
WHITE FLUORINE	8431B	(*)



## YELLOW FLUORINE

MODEL	REF.	G
YELLOW FLUORINE	8431G	(*)



## RED FLUORINE

MODEL	REF.	R
RED FLUORINE	8431R	(*)



## ORANGE FLUORINE

MODEL	REF.	T
ORANGE FLUORINE	8431T	(*)



## GREEN FLUORINE

MODEL	REF.	V
GREEN FLUORINE	8431V	(*)

(\*) Check price with your distributor.

**NOTE:** the set consists on 8 rim strips.

**MATERIAL:** PVC lenticular semi rigid applied on rims of 14" to 21".



# PERFORMANCE ARC STRIPS



\* Check availability for motorcycle models at [www.puig.tv](http://www.puig.tv) typing in the searching window:

**STRIPS**

**NEW!**



**A** Blue  
**B** White

**G** Yellow  
**R** Red

**T** Orange  
**V** Green



## BLUE FLUORINE

MODEL	REF.	A
BLUE FLUORINE	21833A	(*)



## WHITE FLUORINE

MODEL	REF.	B
WHITE FLUORINE	21833B	(*)



## YELLOW FLUORINE

MODEL	REF.	G
YELLOW FLUORINE	21833G	(*)



## RED FLUORINE

MODEL	REF.	R
RED FLUORINE	21833R	(*)



## ORANGE FLUORINE

MODEL	REF.	T
ORANGE FLUORINE	21833T	(*)



## GREEN FLUORINE

MODEL	REF.	V
GREEN FLUORINE	21833V	(*)

(\*) Check price with your distributor.

**NOTE:** the set consists on 8 rim strips.

**MATERIAL:** PVC lenticular semi rigid applied on rims of 14" to 21".



# SPECIAL RIM STRIPS



\* Check availability for motorcycle models at [www.puig.tv](http://www.puig.tv) typing in the searching window:

**STRIPS**



ANTI  
SCRATCH



EASY  
INSTALLATION



IMPACT  
RESISTANT



UV  
PROTECTION

**A** Blue  
**B** White

**G** Yellow  
**O** Gold

**P** Silver  
**R** Red

**T** Orange  
**V** Green

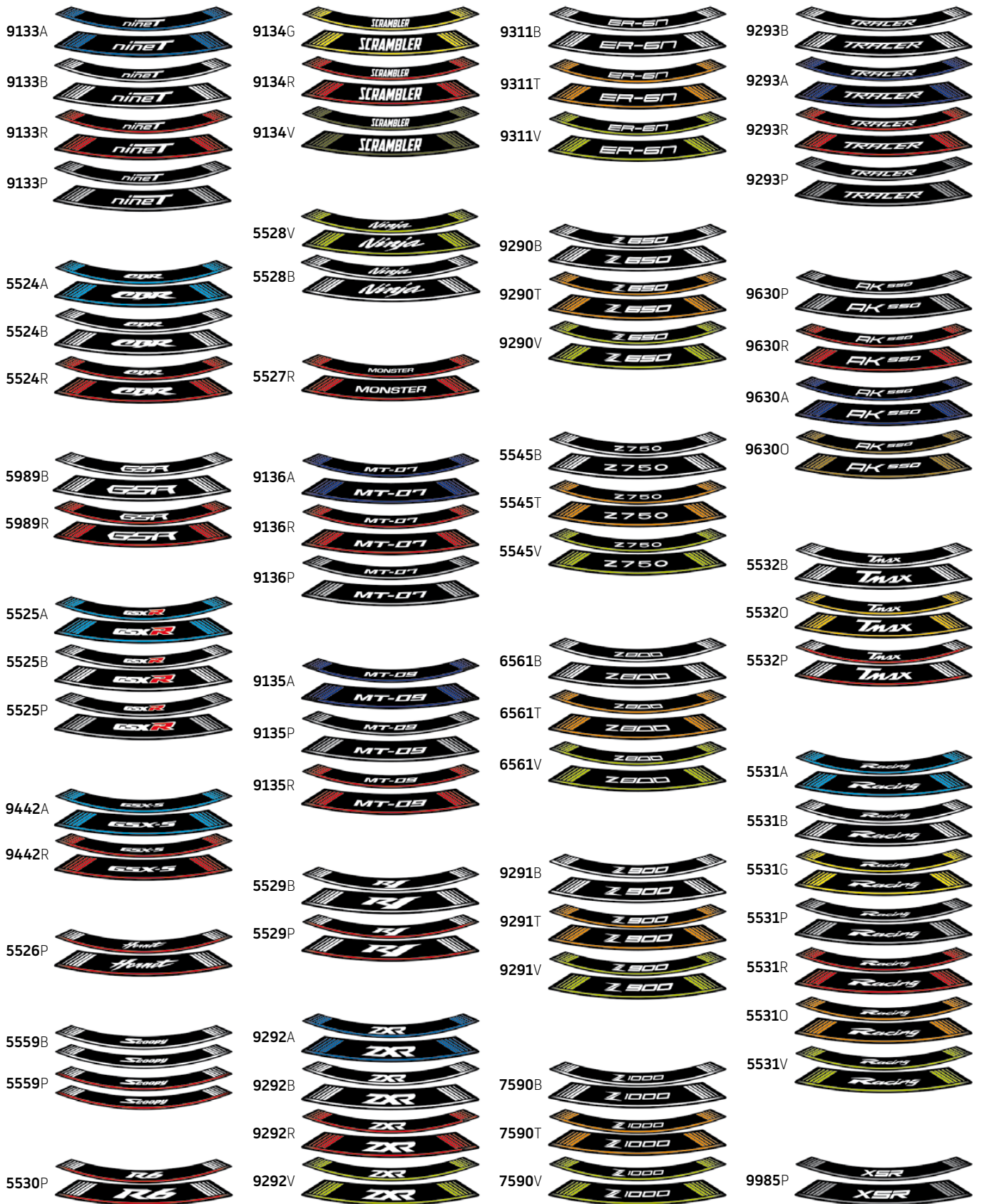

**NOTE:** the set consists on 8 rim strips.

**MATERIAL:** PVC lenticular semi rigid applied on rims of 14" to 21".



# RIM STRIPS GS



\* Check availability for motorcycle models at [www.puig.tv](http://www.puig.tv) typing in the searching window:

**STRIPS**



REF. 20150N



REF. 20151N



REF. 201500



REF. 201510



REF. 20214N



**N** Black

**O** Gold

# SWING ARM PROTECTOR GS



\* Check availability for motorcycle models at [www.puig.tv](http://www.puig.tv) typing in the searching window.

**SWING ARM PROTECTOR**



REF. 201520



REF. 20152B



REF. 20152N



REF. 20213N



REF. 201530



REF. 20153B



REF. 20153N



REF. 20213N

B White

N Black

O Gold



# ADHESIVE KIT FOR BMW CASES



\* Check availability for motorcycle models at [www.puig.tv](http://www.puig.tv) typing in the searching window.

**BMW BOX**

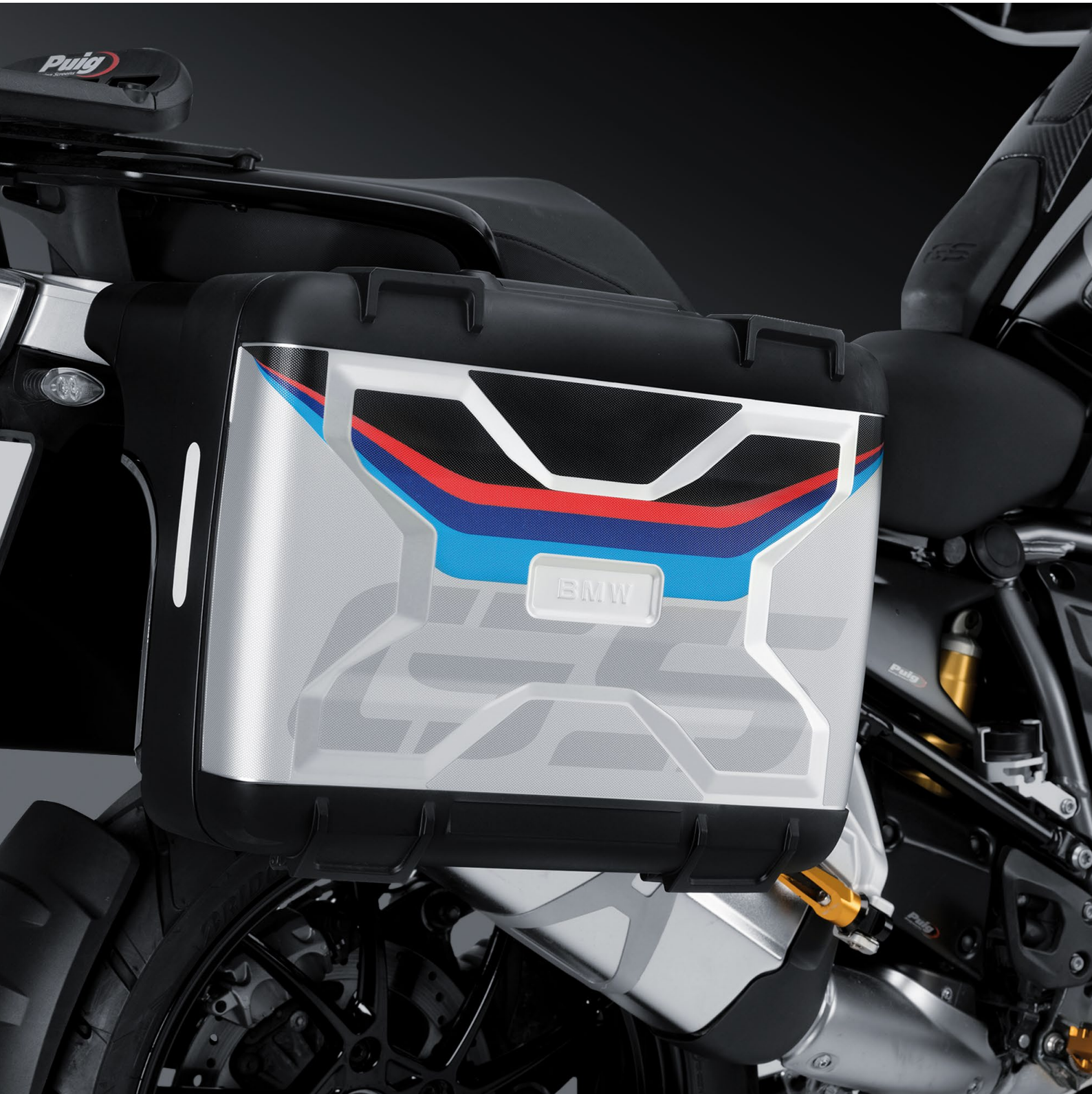



REF. 20216N



REF. 20217N



REF. 20229N



REF. 20230N



REF. 20227N



REF. 20228N



REF. 20231N

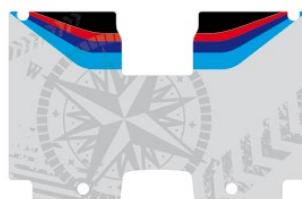

REF. 20232N

**NOTE:** the kit includes adhesives for one case. If you have three cases, you must order 3 units of the reference.



# STAND SUPPORTS



\* Check availability for motorcycle models at [www.puig.tv](http://www.puig.tv) typing in the searching window:

**STAND SUPPORTS**



MODEL	REF.	N
STAND SUPPORT OFF-ROAD BASIC	6289N (#)	(*)

(#) Height on the lower position 310 mm.  
Height on the highest position 400 mm. Maximum load: 200 kg.



MODEL	REF.	N
STAND SUPPORT OFF-ROAD HYDRAULIC	6290N (#)	(*)

(#) Height on the lower position 300 mm.  
Height on the highest position 410 mm. Maximum load: 200 kg.

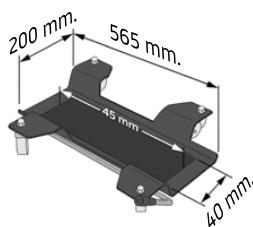

MODEL	REF.	N
BASE PARK&MOVE FOR CENTER STAND	9974N (&)	(*)

(\*) Maximum load: 200 kg.



MODEL	REF.	N
FRONT STAND	4348N	(*)



MODEL	REF.	N
STAND WHEEL LOCK 17" TO 21"	6071N	(*)



MODEL	REF.	N
REAR STAND FOR TWIN SWING ARMS	4322N	(*)

Include pair adaptors for spool and pair of pads for swing arm.

AXIS SPARE	REF.	P
SET OF HOOKS FOR THE REAR STAND IN SILVER	5333P	(*)
ACCESSORIES FOR SWING ARM REAR STAND	4349P	(*)

 N Black

 P Silver

(\*) Check price with your distributor.

# STAND SUPPORTS



\* Check availability for motorcycle models at [www.puig.tv](http://www.puig.tv) typing in the searching window:

**STAND SUPPORTS**



## FRONT HEAD STAND

MODEL	REF.	N
FRONT HEAD STAND INCLUDE AXIS: 13 mm., 15 mm., 16,5 mm., 17 mm., 18 mm., 27 mm.	5601N	(*)

AXIS SPARE	Ø DIAMETER	REF.	N
UNIVERSAL	13 mm.	5596D	(*)
UNIVERSAL	15 mm.	5597D	(*)
UNIVERSAL	16,5 mm.	5598D	(*)
UNIVERSAL	17 mm.	5599D	(*)
UNIVERSAL	18 mm.	5600D	(*)
UNIVERSAL	19 mm.	21707D	(*)
UNIVERSAL	20 mm.	21708D	(*)
UNIVERSAL	22 mm.	21709D	(*)
UNIVERSAL	24 mm.	21710D	(*)
UNIVERSAL	27 mm.	9701D	(*)
UNIVERSAL	27,5 mm.	21711D	(*)



REF. 5332N



REF. 5849N

## REAR STAND FOR SINGLE SWING ARM

MODEL	REF.	N
REAR STAND FOR SINGLE SWING ARM TRANSMISION LEFT SIDE, <b>AXIS INCLUDED</b>		<b>CHECK WEB</b>
REAR STAND FOR SINGLE SWING ARM TRANSMISION RIGHT SIDE, <b>AXIS INCLUDED</b>		<b>CHECK WEB</b>

SPARE PARTS STAND	REF.	N
REAR STAND FOR SINGLE SWING ARM TRANSMISION LEFT SIDE - <b>AXIS NOT INCLUDED</b>	5332N	(*)
REAR STAND FOR SINGLE SWING ARM TRANSMISION RIGHT SIDE - <b>AXIS NOT INCLUDED</b>	5849N	(*)

AXIS SPARE	Ø DIAMETER	REF.	D
BMW (*)	53 mm.	5518D	(*)
BMW (*)	31,5 mm.	5557D	(*)
DUCATI (*)	21,5 mm.	5513D	(*)
DUCATI (*)	38,5 mm.	5897D	(*)
DUCATI (*)	40,7 mm.	5517D	(*)
MV AGUSTA (*)	40,7 mm.	5517D	(*)
MV AGUSTA (*)	42,5 mm	7479D	(*)
HONDA (*)	28,4 mm.	5515D	(*)
TRIUMPH (*)	27,4 mm.	5516D	(*)
KTM (*)	27,4 mm.	5516D	(*)

(\*) Check bike compatibility in our website.

D Aluminium Anodized

N Black

(\*) Check price with your distributor.





# MAINTENANCE WORKSHOP WINTER

---

## MAINTENANCE

---

DIRTY OIL TANK **474**

---

BRUSH CLEANING CHAIN **474**

---

## ACCESSORIES

---

DIGITAL TIRE PRESSURE INDICATOR **475**

---

TIRE REPAIR KIT **475**

---

KICKSTAND BASE SUPPORT **476**

---

FORK PROTECTOR **476**

---

ELASTIC NETS **477**

---

STRAPS **477**

---

NUMBERS **478**

---

THERMAL GLOVES ANTI-VIBRATION **478**

---

## SPARES

---

FAIRING QUICK SCREWS **479**

---

ANODIZED SCREWS KIT **479**

---

WELLNUTS **480**

---

TRIM - EDGING **480**

---

SPIRAL TUBES **480**

---

## WINTER

---

MOTORCYCLE WATERPROOF COVER **481**

---

LEGS COVER MAXISCOOTER **481**

---

HEATED GRIPS **482**

---

SOFT AND SEMI-RIGID HANDGUARDS **483**

---

# MAINTENANCE



## DIRTY OIL TANK

MODEL	REF.	N
DIRTY OIL TANK 8L (600 x 320 x 135 mm.)	5260N	(*)

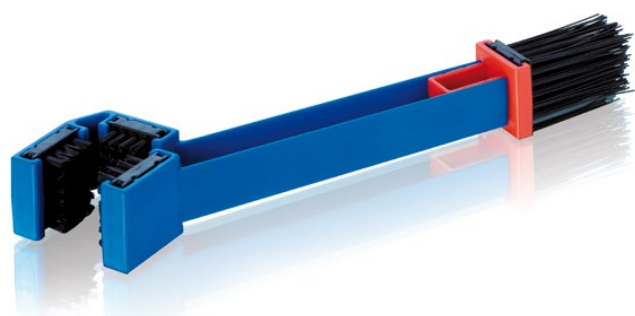

## BRUSH CLEANING CHAIN

MODEL	REF.	A
BRUSH CLEANING CHAIN	5870A	(*)

- A Blue
- N Black

(\*) Check price with your distributor.

# ACCESSORIES



## DIGITAL TIRE PRESSURE INDICATOR

MODEL	REF.	N
DIGITAL TIRE PRESSURE INDICATOR	5401N	(*)



## TIRE REPAIR KIT

MODEL	REF.	N
TIRE REPAIR KIT	5982N	(*)



# ACCESSORIES



## KICKSTAND BASE SUPPORT

MODEL	REF.	N
BASE FOR KICKSTAND WITH BLACK DIAMETER 80 mm.	6335N	(*)



## FORK PROTECTOR

MODEL	REF.	C
UNIVERSAL BY PAIR C/CARBON LOOK	1320C	(*)

 C Carbon look  
 N Black

(\*) Check price with your distributor.

# ACCESSORIES

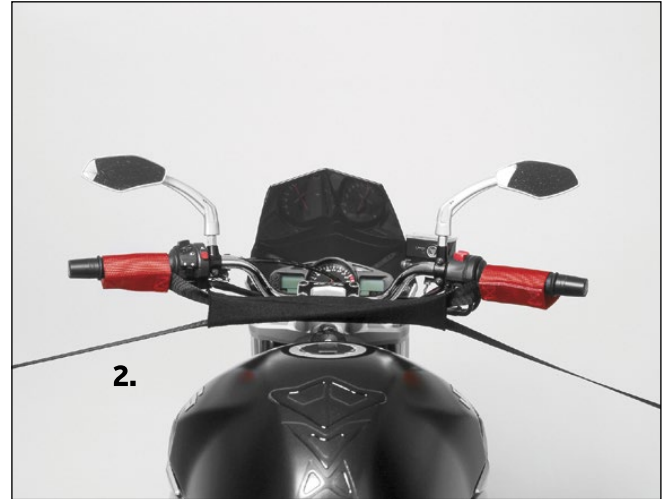

## ELASTIC NETS

MODEL	REF.	A B G L N R T V
RED	0788	(*)



## STRAPS

MODEL	REF.	N
(1) TIE DOWN WITH HOOKS BY PAIR C/BLACK	6274N	(*)
(2) BAR STRAPS BY PAIR C/BLACK	4592N	(*)

■ A Blue  
  B White

■ G Yellow  
■ L Violet

■ N Black  
■ R Red

■ T Orange  
■ V Green

(\*) Check price with your distributor.

# ACCESSORIES



**0 1 2 3 5**  
**4 6 7 8 9**



## NUMBERS

MODEL	PACK	REF.	A B G N P R V
0	5 UNITS	4263	(*)
1	5 UNITS	4254	(*)
2	5 UNITS	4255	(*)
3	5 UNITS	4256	(*)
4	5 UNITS	4257	(*)
5	5 UNITS	4258	(*)
6	5 UNITS	4259	(*)
7	5 UNITS	4260	(*)
8	5 UNITS	4261	(*)
9	5 UNITS	4262	(*)
DISPLAY		2562N	(*)



## THERMAL GLOVES ANTI-VIBRATION

MODEL	REF.	A N O R V
THERMAL GLOVES ANTI-VIBRATION BY PAIR C/BLACK	7778N	(*)
THERMAL GLOVES ANTI-VIBRATION BY PAIR C/RED	7778R	(*)
THERMAL GLOVES ANTI-VIBRATION BY PAIR C/BLUE	7778A	(*)
THERMAL GLOVES ANTI-VIBRATION BY PAIR C/GREEN	7778V	(*)
THERMAL GLOVES ANTI-VIBRATION BY PAIR C/ORANGE	7778T	(*)

**A** Blue  
**B** White

**G** Yellow  
**N** Black

**P** Silver  
**R** Red

**T** Orange  
**V** Green

(\*) Check price with your distributor.

# SPARES

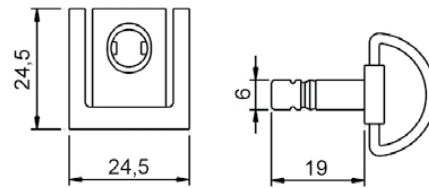

## FAIRING QUICK SCREWS

MODEL	REF.	D
BLISTER 6 FAIRING QUICK SCREWS + BRACKETS	5484D	(*)

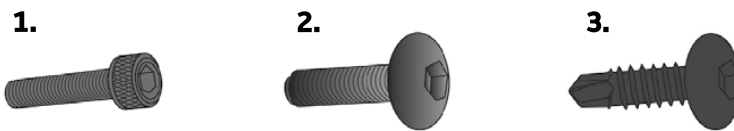

## ANODIZED SCREWS KIT

MODEL	REF.	A	G	L	N	P	R	V
BLISTER 6 ALLEN SCREWS M5 x 15 mm. (1)	0146							(*)
BLISTER 6 ALLEN SCREWS M5 x 20 mm. (1)	0147							(*)
BLISTER 6 ALLEN SCREWS M5 x 25 mm. (1)	0185							(*)
BLISTER 6 ALLEN SCREWS M6 x 15 mm. (1)	0363							(*)
BLISTER 6 ALLEN SCREWS M6 x 20 mm. (1)	0364							(*)
BLISTER 6 ALLEN SCREWS M6 x 25 mm. (1)	0544							(*)
BLISTER 6 ALLEN SCREWS M6 x 30 mm. (1)	0258							(*)
BLISTER 6 ALLEN SCREWS M6 x 35 mm. (1)	0346							(*)
BLISTER 6 ALLEN SCREWS M6 x 45 mm. (1)	0370							(*)
BLISTER 6 ALLEN SCREWS M6 x 50 mm. (1)	0421							(*)
BLISTER 6 ALLEN SCREWS M6 x 55 mm. (1)	0446							(*)
BLISTER 6 ALLEN SCREWS M8 x 30 mm. (1)	0473							(*)
BLISTER 6 ALLEN SCREWS M8 x 35 mm. (1)	0500							(*)
BLISTER 6 ALLEN SCREWS M8 x 45 mm. (1)	0516							(*)
BLISTER 6 ALLEN SCREWS M8 x 50 mm. (1)	0524							(*)
BLISTER 6 ALLEN SCREWS M8 x 55 mm. (1)	0540							(*)
BLISTER 6 ALLEN HEAD SCREWS M5 x 15 mm. (2)	0543							(*)
BLISTER 6 ALLEN HEAD SCREWS M5 x 20 mm. (2)	0550							(*)
BLISTER 6 ALLEN HEAD SCREWS M5 x 25 mm. (2)	0610							(*)
BLISTER 6 ALLEN HEAD SCREWS M6 x 15 mm. (2)	0611							(*)
BLISTER 6 ALLEN HEAD SCREWS M5 x 20 mm. (2)	0657							(*)
BLISTER 6 ALLEN HEAD SCREWS M6 x 25 mm. (2)	0689							(*)
BLISTER 6 ALLEN HEAD SCREWS M6 x 30 mm. (2)	3995							(*)
BLISTER 6 LOCK NUTS M5	0735							(*)
BLISTER 6 LOCK NUTS M6	0736							(*)
BLISTER 6 LOCK NUTS M8	0832							(*)
BLISTER 6 NUTS M5	0763							(*)
BLISTER 6 NUTS M6	0764							(*)
BLISTER 6 NUTS M8	0863							(*)
BLISTER 6 ALLEN HEAD IRON THREAD SCREWS M6 x 20 mm. (3)	2542							(*)
BLISTER 6 ALLEN HEAD IRON THREAD SCREWS M6 x 30 mm. (3)	2543							(*)
PLASTIC BOX (#) (LENGTH 300 x HEIGHT 30 x WIDTH 150)	3961W (#)							(*)

(#) With 32 departaments. Delivered 6 screws each of the most common references.

**A** Blue  
**D** Aluminium Anodized

**G** Yellow  
**L** Violet

**N** Black  
**P** Silver

**R** Red  
**V** Green

(\*) Check price with your distributor.



# SPARES

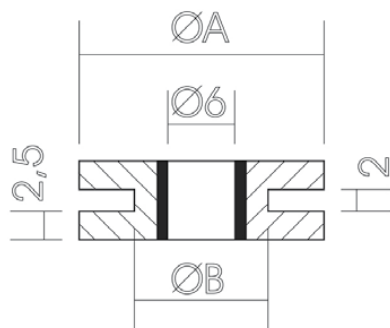

## WELLNUTS

AxBxCxDxExG	REF.	N
22 x 12	1888N	(*)

Wellnuts (25 units in sac).

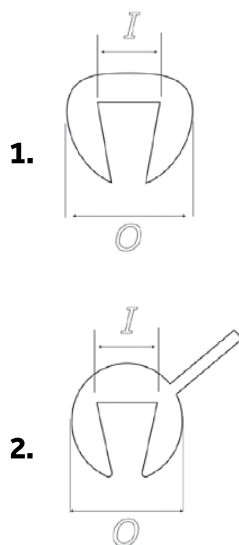

## TRIM - EDGING

Ø x l	COLOR	REF.	ROLL	H N W
6,2 x 3,6 (1)	CLEAR	4303W	200 mts.	(*)
6,2 x 3,6 (2)	SMOKE	4748H	200 mts.	(*)
3 x 1,5 (1)	BLACK	5590N	50 mts.	(*)
6 x 3 (1)	BLACK WITH ADHESIVE	0088N	25 mts.	(*)



## SPIRAL TUBES

MODEL	REF.	G L
ROLL OF 10 METERS	0892G	(*)
ROLL OF 10 METERS	0892L	(*)

■ G Yellow  
■ H Smoke

■ J Matt black  
■ L Violet

W Clear

(\*) Check price with your distributor.

# WINTER



## MOTORCYCLE WATERPROOF COVER

MODEL	REF.	N
MOTORCYCLE COVER PUIG LOGO XL	20725N	(*)
MOTORCYCLE COVER PUIG LOGO XXL	20726N	(*)
MOTORCYCLE COVER PUIG LOGO XXXL	20727N	(*)



## LEGS COVER MAXISCOOTER

MODEL	REF.	N
UNIVERSAL LEGS COVER RAINCOAT	9749N	(*)

# WINTER



## HEATED GRIPS

MODEL	REF.	N
SET WITH HANDLES THERMOSTAT HANDLEBARS 22 / 22,2 mm.	5020N	(*)

# WINTER



REF. 6845N



REF. 5486N



REF. 3863N



## SOFT AND SEMI-RIGID HANDGUARDS

MODEL	REF.	N
UNIVERSAL SEMI-RIGID HANDGUARDS	6845N	(*)
UNIVERSAL MOTO / SCOOTER HANDGUARDS	5486N	(*)
UNIVERSAL SCOOTER HANDGUARDS	3863N	(*)





**Motoplastic-Puig** has a blowing division specialized in the manufacture of special trunks for the delivery sector and supports for the best-selling scooters. Presented in different formats and sizes to meet all transportation needs. They are made of polypropylene with high resistance to impact and with a certificate of suitability for contact with food. Its manufacturing system guarantees an excellent ratio between the weight of the trunk, its load capacity and shock absorption. They come in three colors and with a locking system that allows its use with or without a key. As they are references of considerable volume and as they are shipped directly from the manufacturing plant, the shipping costs will be billed separately, even if the amount paid is reached for orders over € 1.000 gross.

# DELIVERY

---

<b>MEGA BOX TOP BOX</b>	<b>486</b>
MEGA BOX WITH LOCK WITH KEY	<b>487</b>
THERMAL BAG	<b>487</b>
<b>MAXI BOX TOP BOX</b>	<b>488</b>
MAXI BOX WITH LOCK WITH KEY	<b>489</b>
MAXI BOX WITH LOCK AND FIXED WITH CINCHES	<b>489</b>
THERMAL BAG	<b>489</b>
<b>BIG BOX TOP BOX</b>	<b>490</b>
BIG BOX WITH LOCK WITH KEY	<b>491</b>
THERMAL BAG	<b>491</b>
<b>TRUNK INSTALLATION KIT</b>	<b>492</b>

---

# MEGA BOX TOP BOX



\* Check availability for motorcycle models at [www.puig.tv](http://www.puig.tv) typing in the searching window:

**MEGA BOX**



B White

N Black

R Red

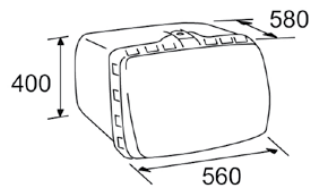

## MEGA BOX WITH LOCK WITH KEY

MODEL	REF.	MATERIAL	B N R
UNIVERSAL	2328	POLYPROPYLENE	(*)
METALLIC BASE	3506N		(*)
TRAY KIT (OPTIONAL)	3844N	ABS	(*)
SPARE LOCK WITH KEY (*)	7548N		(*)
TRUNK LID	20707	POLYPROPYLENE	(*)

(\*) Locking system that allows its use with or without a key.



## THERMAL BAG

MODEL	REF.	R
THERMAL BAG 45 x 45 x 24 cm.	9250	(*)



\* Check availability for motorcycle models at [www.puig.tv](http://www.puig.tv) typing in the searching window:

**BAG**

(\*) Check price with your distributor.



# MAXI BOX TOP BOX



\* Check availability for motorcycle models at [www.puig.tv](http://www.puig.tv) typing in the searching window:

**MAXI BOX**



B White

N Black

R Red

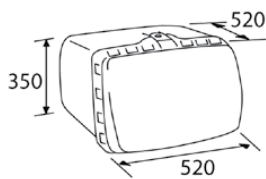

### MAXI BOX WITH LOCK WITH KEY

MODEL	REF.	MATERIAL	B N R
UNIVERSAL	0468	POLYPROPYLENE	(*)
TRAY KIT (OPTIONAL)	1886N	ABS	(*)
SPARE LOCK WITH KEY (*)	7548N		(*)
METALLIC BASE	9329N		(*)
SQUARE HINGE	9851N		(*)
PIVOT	3808N		(*)

(\*) Locking system that allows its use with or without a key.

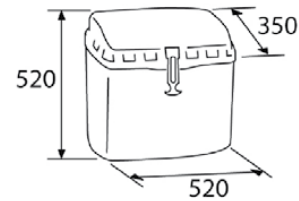

### MAXI BOX WITH LOCK AND FIXED WITH CINCHES

MODEL	REF.	MATERIAL	B N R
UNIVERSAL	3659	POLYPROPYLENE	(*)
HOOKS BY PAIR	3828		(*)



### THERMAL BAG

MODEL	REF.	R
THERMAL BAG 45 x 45 x 24 cm.	9250	(*)



\* Check availability for motorcycle models at [www.puig.tv](http://www.puig.tv) typing in the searching window:

**BAG**

(\*) Check price with your distributor.

# BIG BOX TOP BOX



\* Check availability for motorcycle models at [www.puig.tv](http://www.puig.tv) typing in the searching window:

**BIG BOX**



B White

N Black

R Red

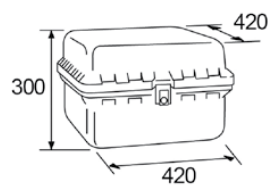

60 L.

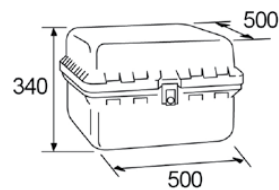

90 L.

## BIG BOX WITH LOCK WITH KEY

MODEL	REF.	MATERIAL	B N	R
UNIVERSAL 60L.	0390	POLYPROPYLENE	(*)	
UNIVERSAL 90L.	0713	POLYPROPYLENE	(*)	(*)
SPARE LOCK WITH KEY (*)	7548N		(*)	
SPARE SIDE LOCK	3192N		(*)	

(\*) Locking system that allows its use with or without a key.



## THERMAL BAG

MODEL	REF.	R
THERMAL BAG 45 x 45 x 24 cm.	9250	(*)

(\*) Compatible only with Big Box 90L. (Ref. 0713).



\* Check availability for motorcycle models at [www.puig.tv](http://www.puig.tv) typing in the searching window.

**BAG**

(\*) Check price with your distributor.



# TRUNK INSTALLATION KIT



\* Check availability for motorcycle models at [www.puig.tv](http://www.puig.tv) typing in the searching window:

**BOX KIT**



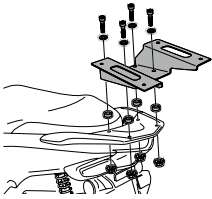

REF. 20572N

**EASE**

For assembly, all the necessary hardware is supplied for the indicated models.

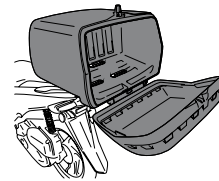
**EFFICIENCY**

They leave the suitcase in a horizontal position ensuring proper food transport.

**SECURITY**

Studied to properly support the trunk.

**FUNCTIONALITY**

They allow the correct opening of the scooter seat.



**NOTE:** not compatible with the Mega Box model.



# MERCHANDISING

ANODIZED PIECES DISPLAY	497
BACKPACK	500
CAP	501
CATALOG	498
DESKTOP SUPPORT FOR MOBILE	499
DISPLAY SCREENS	496
DISPLAY STRIP	496
FLAG	498
FLASK	499
FRAME SLIDERS DISPLAY	497
GLOVES	501
HI-TECH PARTS DISPLAY	497
HOODIE	501
JACKET SOFTSHELL	500
KEYCHAINS	501
METACRYLATE PUIG	498
MUG	502
NECK WARMER	500
OUTDOOR POLYESTER TENT	502
PEN / NOTEBOOK	499
PUIG STICKERS	498
RUG	499
SAFETY DISTANCE STICKER KIT	502
TURN SIGNALS DISPLAY	496
UNISEX T-SHIRTS	500
VISOR DISPLAY	496



# MERCHANDISING

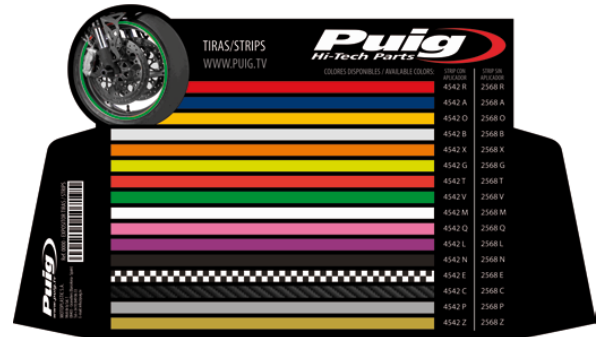

## DISPLAY SCREENS

MODEL	REF.
DISPLAY SCREENS COLORS	1196R

## DISPLAY STRIP

MODEL	REF.
STRIP COLOR DISPLAY	9180N



## VISOR DISPLAY

MODEL	REF.	N
VISOR DISPLAY	20497N	(*)



## TURN SIGNALS DISPLAY

MODEL	REF.	N
TURN SIGNALS DISPLAY	20860N	(*)

N Black

R Red

(\*) Check price with your distributor.

REF. 9665R



REF. 20315N



### ANODIZED PIECES DISPLAY

MODEL	REF.	N R
DISPLAY LEVER + REAR MIRROR + BAR END + GRIP	9665R	(*)
DISPLAY LEVER 3.0	20315N	(*)



### HI-TECH PARTS DISPLAY

MODEL	REF.	N
HI-TECH PARTS DISPLAY 854 x 1900 mm.	7324N	(*)



**NEW!**

### FRAME SLIDERS DISPLAY

MODEL	REF.	N
FRAME SLIDERS DISPLAY	4597N	(*)

■ N Black

■ R Red

(\*) Check price with your distributor.

# MERCHANDISING



## CATALOG

MODEL	REF.
CATALOG 2024 SPANISH VERSION	21528
CATALOG 2024 FRENCH VERSION	21529
CATALOG 2024 ENGLISH VERSION	21530
CATALOG 2024 GERMAN VERSION	21531

## PUIG STICKERS

MODEL	REF.	N
LARGE PUIG ADHESIVE 400 mm.	9348N	(*)
ADHESIVE PUIG MEDIUM 135 x 33 mm.	9349N	(*)



## METACRYLATE PUIG

MODEL	REF.	B
METACRYLATE PUIG 660 x 300 x 3 mm.	2203B	(*)

## FLAG

MODEL	REF.	N
FLAG 200 x 90 cm. PUIG HI-TECH PARTS	3669N	(*)

B White

N Black

(\*) Check price with your distributor.



**PEN / NOTEBOOK**

MODEL	REF.	N
PEN	9347N	(*)
NOTEBOOK	9312N	(*)



**RUG**

MODEL	REF.	N
RUG PUIG 2000 x 800 mm.	6362N	(*)

**MANUFACTURED:** 100% Nylon, non-slip and waterproof.



**FLASK**

MODEL	REF.	N
FLASK 500 ml.	20499N	(*)



**DESKTOP SUPPORT FOR MOBILE**

MODEL	REF.	W
DESKTOP SUPPORT FOR MOBILE METACRILATO	21111W	(*)

N Black

W Clear

(\*) Check price with your distributor.



# MERCHANDISING



## UNISEX T-SHIRTS

MODEL	REF.	N
SIZE S	4335N	(*)
SIZE M	4334N	(*)
SIZE L	4333N	(*)
SIZE XL	4332N	(*)
SIZE XXL	4336N	(*)
SIZE XXXL	9343N	(*)
SIZE XXXXL	9344N	(*)



## JACKET SOFTSHELL

MODEL	REF.	N
SIZE XS	9857N	(*)
SIZE S	9858N	(*)
SIZE M	9859N	(*)
SIZE L	9860N	(*)
SIZE XL	9861N	(*)
SIZE XXL	9862N	(*)
SIZE XXXL	9863N	(*)
SIZE XXXXL	21408N	(*)



## NECK WARMER

MODEL	REF.	N
NECK WARMER PUIG	9345N	(*)



## BACKPACK

MODEL	REF.	N
BACKPACK PUIG	9228N	(*)

■ N Black

(\*) Check price with your distributor.



## HOODIE

MODEL	REF.	N
SIZE XS	3746N	(*)
SIZE S	3747N	(*)
SIZE M	3748N	(*)
SIZE L	3749N	(*)
SIZE XL	3750N	(*)
SIZE XXL	3751N	(*)



## GLOVES

MODEL	REF.	N
SIZE S	20786N	(*)
SIZE M	20787N	(*)
SIZE L	20788N	(*)
SIZE XL	20789N	(*)



## CAP

MODEL	REF.	N
CAP HI-TECH PARTS	9346N	(*)



## KEYCHAINS

MODEL	REF.	N
KEYCHAIN WITH TAPE	9227N	(*)
KEY SUPPORT WITH ZIP CLOSURE	8120N	(*)

■ N Black

(\*) Check price with your distributor.

# MERCHANDISING



## MUG

MODEL	REF.	N
MUG	3753N	(*)



## SAFETY DISTANCE STICKER KIT

MODEL	REF.	N
SAFETY DISTANCE STICKER KIT	20368N	(*)

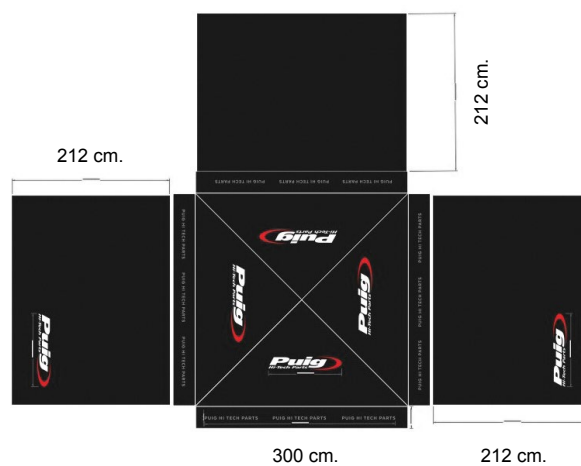

## OUTDOOR POLYESTER TENT

MODEL	REF.	N
OUTDOOR POLYESTER TENT 3 X 3 m. ADJUSTABLE 212 x 320 cm.	21447N	(*)





#### **SALES CONDITIONS**

- 1% extra discount sending the order through our extranet on **www.puig.tv**

#### **RETURN PROCEDURES**

- No return will be accepted after 3 months from shipping note.
- The return must be accepted from Motoplastic S.A., after verification of the material by an agent in the area or, otherwise, through an email sent to **devoluciones@puig.tv** requesting the return along with detailed images.
- If the return is not Motoplastic's fault, 20% devaluation will be applied and material will need to be sent paid for.
- If the return is because of the transport, the customer will need to send us the transporter's shipping note where should be noted, at the time of the reception of the cartons, the disagreement of the condition of the material. Additionally, images of the cartons in bad condition will need to be sent to us.

#### **BRAND AND IMAGES**

PUIG® is a registered brand.

The images from this catalog and site **www.puig.tv** are property of Motoplastic, S.A. and need authorization from Motoplastic, S.A. for its use.

Motoplastic, S.A. does not have any link with brands HONDA, YAMAHA, SUZUKI, KAWASAKI, APRILIA, BMW, BUELL, CAGIVA, DERBI, DUCATI, HYOSUNG, KTM, MV AGUSTA, PEUGEOT, TRIUMPH and others mentioned. All products registered brand, model or initials, are named with only purpose to cross reference with accessories of our own production.



**Puig**  
*Hi-Tech Parts*

w w w . p u i g . t v

**HEADQUARTERS**  
MOTOPLASTIC, S.A.

Passeig de la Ribera, nº29  
08403 Granollers  
Spain

Tel. (+34) 938 49 06 33  
info@puig.tv

**UNITED STATES**  
PUIG USA INC.

3843 St. Valentine Way  
Orlando, FL 32811

Ph. (+1) 407 237 0207  
info@puigusa.com