

# KAWASAKI VULCAN S '15-

## M O U N T I N G I N S T R U C T I O N S

REF 3817

GUARDABARROS DELANTERO / FRONT FENDER



1 Person



20 min







MEDIUM



N° 10  
N° 12

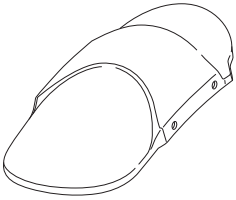
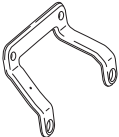
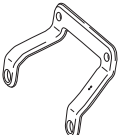

ALLEN  
N° 3  
N° 8  
N° 14

ID	PIEZA/PART	DESCRIPCIÓN	DESCRIPTION	QTY	REF
1		Guardabarros delantero	Front Fender	1	3735N
2		Soporte metálico derecho (•)	Right metal suport (•)	1	SOPOR2P3-R-3817
3		Soporte metálico izquierdo (••)	Left metal suport (••)	1	SOPOR2P3-L-3817
4		Tuerca autoblocante M5	M5 lock nut	4	TUERCA-D985-535
5		Tornillo Allen M5x11 Ø11 ISO 7380	M5x11 Ø11 ISO 7380 Allen screw	4	TORNI-AI----520
6		Tapón tornillo Allen M5 ISO 7380	M5 ISO 7380 Allen screw cap	4	TAPON-----85

# KAWASAKI VULCAN S '15-

INSTRUCCIONES DE MONTAJE - MOUNTING INSTRUCTIONS - MONTAGEANLEITUNG

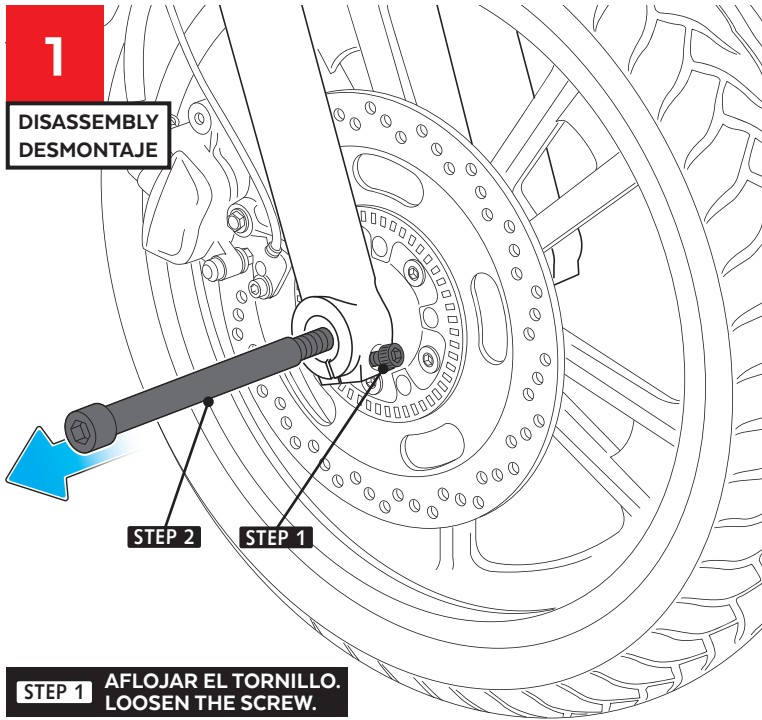

**STEP 1** AFLOJAR EL TORNILLO.  
LOOSEN THE SCREW.

ELEVAR LA RUEDA DELANTERA PARA EXTRAER EL EJE.  
RAISE THE FRONT WHEEL TO REMOVE THE AXLE.

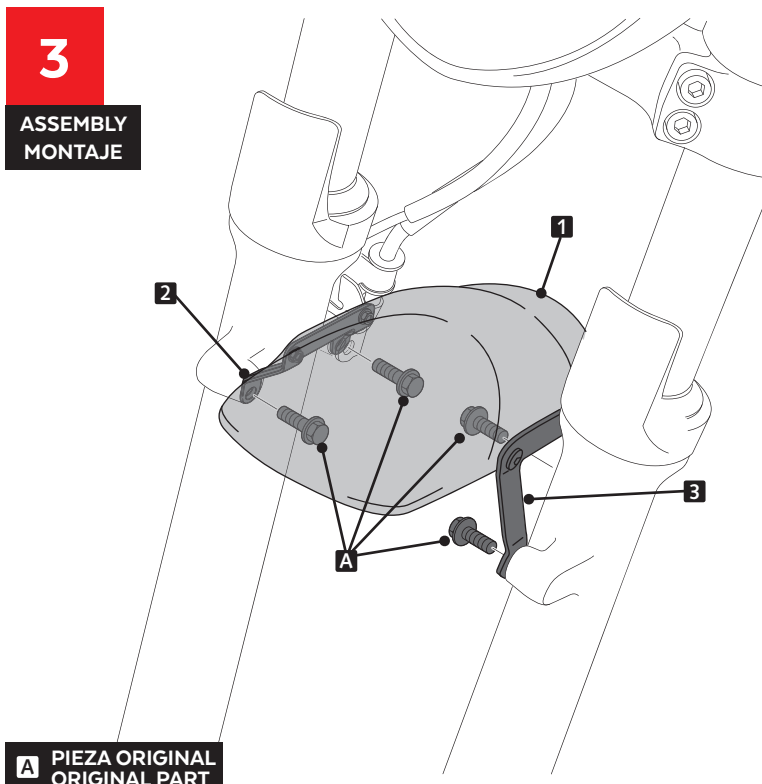
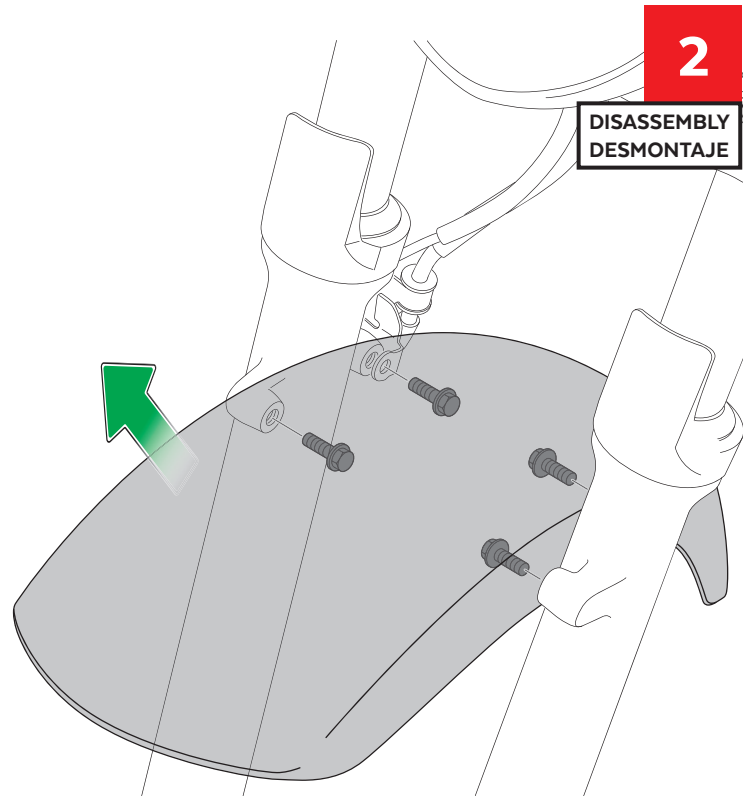

**A** PIEZA ORIGINAL  
ORIGINAL PART

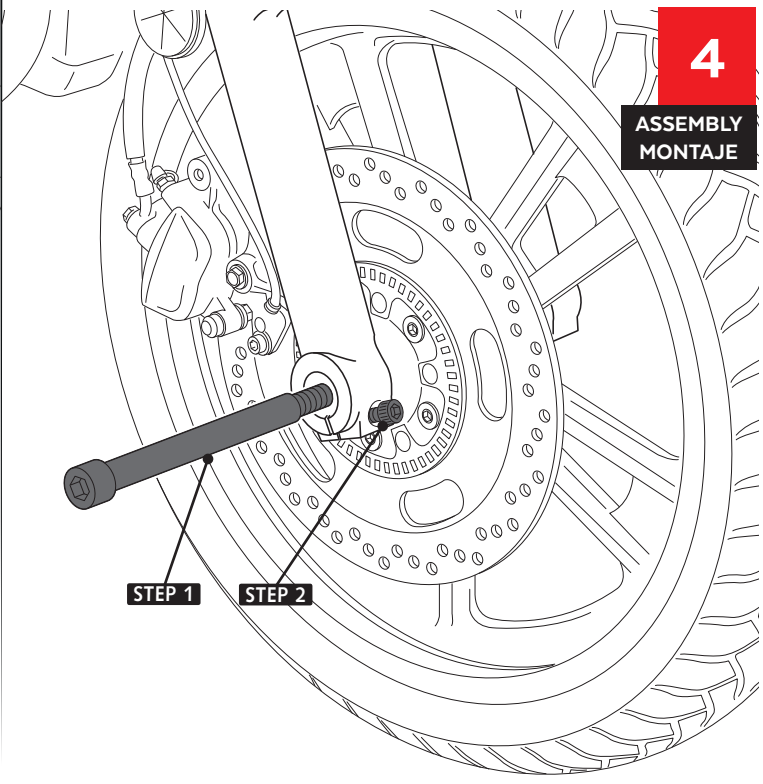

# KAWASAKI VULCAN S '15-

## EXPLOTING

