



NEWS
2020

ADJUSTABLE SCREENS

HI-TECH PARTS | TECHNICAL SECTION



// SCREEN TESTED IN THE VIRTUAL WIND TUNNEL

Improved aerodynamics and wind protection on average +12,7% .

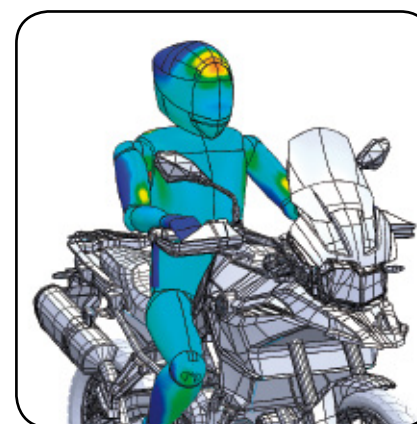

- Lower pressure
- Max. pressure

Wind pressure with adjustable Puig windscreen in low position.

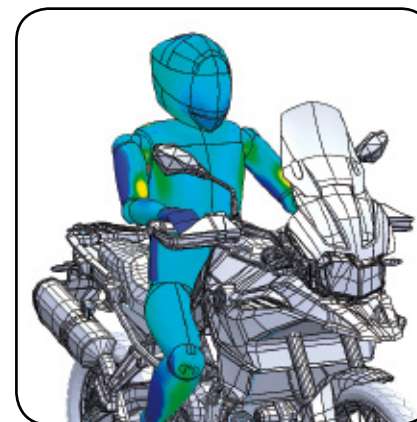

- Lower pressure
- Max. pressure

Wind pressure with adjustable Puig windscreen in high position.

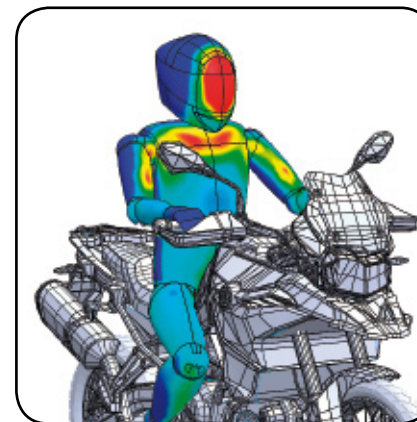

Wind pressure with the original windscreen.



Aerodynamic test delivered with almost all our screens. Check our website.





RISERS
HI-TECH PARTS | TECHNICAL SECTION

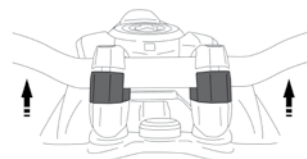

FUNCTIONAL
Allows the handlebars to be raised

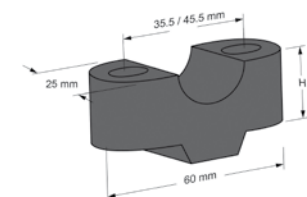

MEASUREMENTS

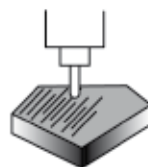

CNC MACHINED
Machined from billet aluminium and anodized in different colors.



N Black
P Aluminium



PART# 3672



PART# 3671

H (mm.)	PART#	P N
20	3671	(*)
30	3672	(*)

(*) Check the price with your distributor.
IMPORTANT: Indicate code color after part#. Example: 0973A

DREI TANK PADS
HI-TECH PARTS



MODEL	PART#	PRICE
DREI CARBON LOOK	3075C	(*)
DREI TRANSPARENT	3075W	(*)

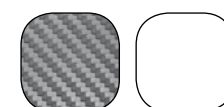

C Carbon Look
W Transparent

(*) Check the price with your distributor.
IMPORTANT: Indicate code color after part#. Example: 0973A

LEVERS 3.0

HI-TECH PARTS | TECHNICAL SECTION



FOLDABLE MODEL 3.0	PART#	
FOLDABLE BRAKE LEVER	CHECK WEB	(*)
ADAPTOR BRAKE LEVER	CHECK WEB	
FOLDABLE CLUTCH LEVER	CHECK WEB	(*)
ADAPTOR CLUTCH LEVER	CHECK WEB	
SELECTOR (SPARES)	3699	(*)
SCREW-NUT-SPACER-WASHER-SPRING (SPARES)	9837	(*)
SPRING	3512	(*)

NON-FOLDABLE MODEL 3.0	PART#	
NON-FOLDABLE BRAKE LEVER	CHECK WEB	(*)
ADAPTOR BRAKE LEVER	CHECK WEB	
NON-FOLDABLE CLUTCH LEVER	CHECK WEB	(*)
ADAPTOR CLUTCH LEVER	CHECK WEB	
SELECTOR (SPARES)	3699	(*)
SCREW-NUT-SPACER-WASHER-SPRING (SPARES)	9837	(*)
SPRING	3512	(*)

SHORT MODEL 3.0	PART#	
SHORT BRAKE LEVER	CHECK WEB	(*)
ADAPTOR BRAKE LEVER	CHECK WEB	
SHORT CLUTCH LEVER	CHECK WEB	(*)
ADAPTOR CLUTCH LEVER	CHECK WEB	
SELECTOR (SPARES)	3699	(*)
SCREW-NUT-SPACER-WASHER-SPRING (SPARES)	9837	(*)
SPRING	3512	(*)

EXTENDABLE FOLDABLE MODEL 3.0	PART#	
EXTENDABLE FOLDABLE BRAKE LEVER	CHECK WEB	(*)
ADAPTOR BRAKE LEVER	CHECK WEB	
EXTENDABLE FOLDING CLUTCH LEVER	CHECK WEB	(*)
ADAPTOR CLUTCH LEVER	CHECK WEB	
SELECTOR (SPARES)	3699	(*)
EXTENDABLE KIT	3700	(*)
SCREW-NUT-SPACER-WASHER-SPRING (SPARES)	9837	(*)
SPRING	3512	(*)

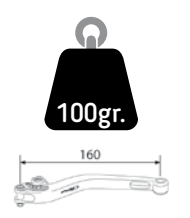

REARVIEW MIRROR MONACO

HI-TECH PARTS | TECHNICAL SECTION



ANTI GLARE
GLASS

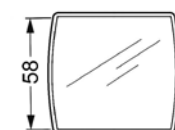

NOT HOMOLOGATED
Ø 58 mm.

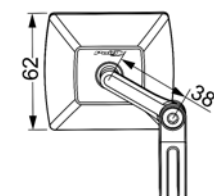

ADJUSTABLE
Inclination and height.

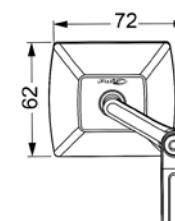
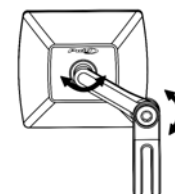

ADAPTABLE
To handlebar bar end.

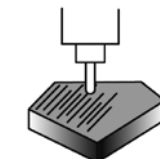

MATERIAL
Manufactured from
billet aluminium and
anodized.

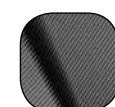

N
Black

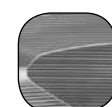

D
Anodized Aluminium

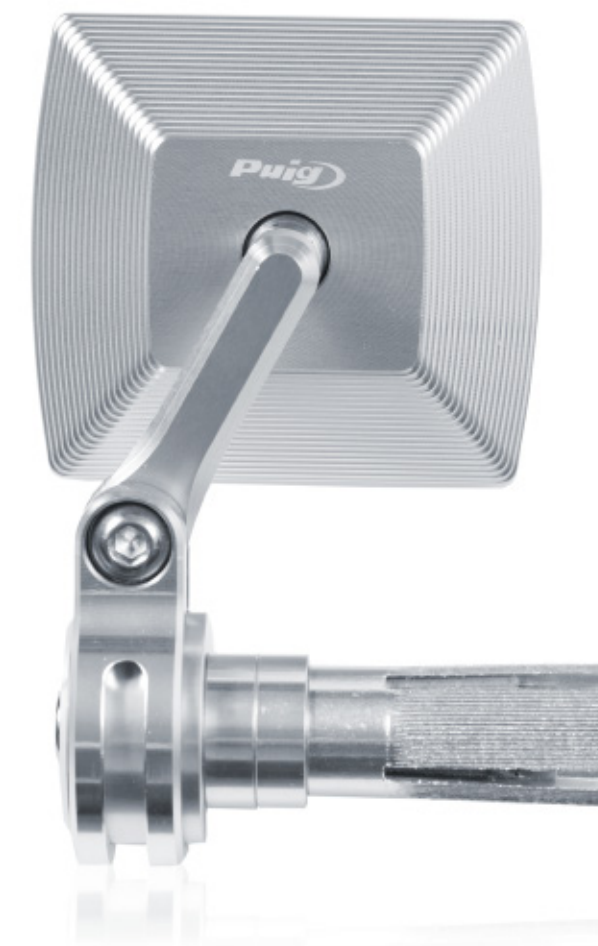

MODEL	SIDE	PART#	N D
UNIVERSAL	RIGHT	3668	(*)
UNIVERSAL	LEFT	3668	(*)

CHECK WEB TO SEE PART# FOR THE ADAPTORS ON THE MODELS AVAILABLE.

(*) Check the price with your distributor.
IMPORTANT: Indicate code color after part#. Example: 0973A

REARVIEW MIRROR F1.1.

HI-TECH PARTS | TECHNICAL SECTION



ANTI GLARE GLASS



NOT HOMOLOGATED

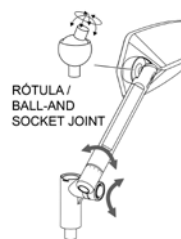

RÓTULA / BALL-AND-SOCKET JOINT

ADJUSTABLE

Inclination, adjustment, and extension of the mirror.

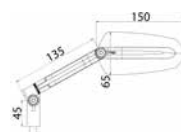

ADAPTABLE

Available adapters for handlebar and fairing fitting.

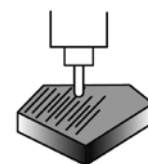

MATERIAL

Manufactured from billet aluminium and anodized.

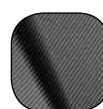

N
Black

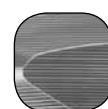

D
Anodized Aluminium

MODEL	SIDE	PART#	N D
UNIVERSAL THREAD M10	RIGHT	017NN (1) (#)	(*)
UNIVERSAL THREAD M10	RIGHT	017DD (2) (#)	(*)
UNIVERSAL THREAD M10	RIGHT	017DN (3) (#)	(*)
UNIVERSAL THREAD M10	RIGHT	017ND (4) (#)	(*)
UNIVERSAL THREAD M10	LEFT	018NN (1)	(*)
UNIVERSAL THREAD M10	LEFT	018DD (2)	(*)
UNIVERSAL THREAD M10	LEFT	018DN (3)	(*)
UNIVERSAL THREAD M10	LEFT	018ND (4)	(*)

CHECK WEB TO SEE PART# FOR THE ADAPTORS ON THE MODELS AVAILABLE. THOSE MODELS REQUIRING ADAPTORS TO ATTACH TO THE FAIRING CHECK WEB.

(#) KIT ADAPTER DELIVERED: M10 x 1,25(reverse thread).

(*) Check the price with your distributor.

IMPORTANT: Indicate code color after part#. Example: 0973A

DEVICE SUPPORT

HI-TECH PARTS | TECHNICAL SECTION

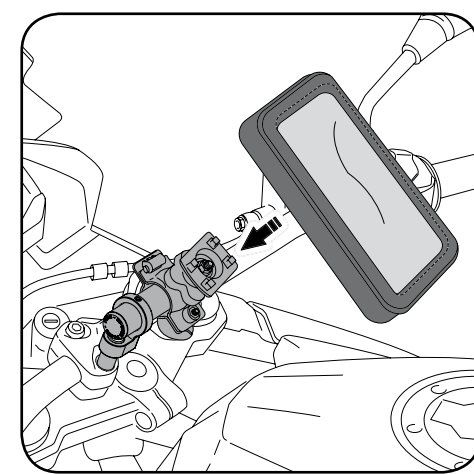
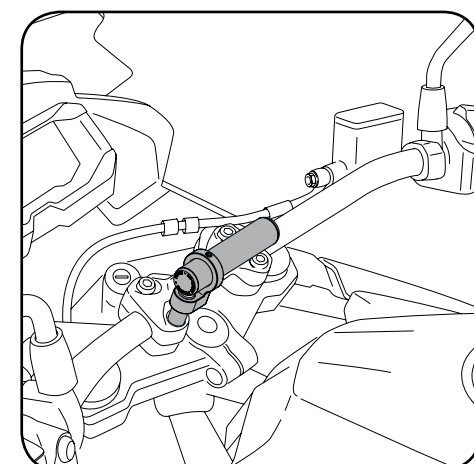
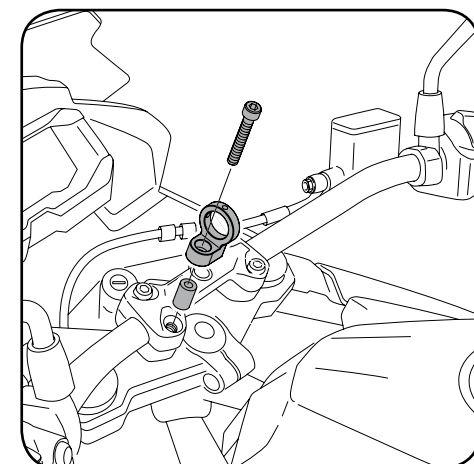

// DEVICE HANDLEBAR SUPPORT

Smartphone mount of superior quality, with machined parts in billet aluminium and anodized in silver color. Diameter of the tube is 20mm and 80mm in length which allows the attachment of several products such as GPS, cel phone, etc. It attaches easily and quickly. It is offered with screws in different lengths to adapt it to any motorcycle.

Available for a wide range of models, consult adjustability to the motorcycle model in the web. It requires that you buy the 3534N support. Compatible with Puig Motoplastic covers for fast application ref. 3530N and 3531N.

MODEL	PART#	P
HANDLEBAR BAR SUPPORT	3570P	(*)

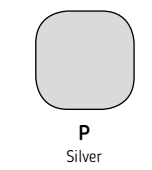

(*) Check the price with your distributor.
IMPORTANT: Indicate code color after part#. Example: 0973A

MOBILE SUPPORTS

HI-TECH PARTS | TECHNICAL SECTION

// HANDLEBAR

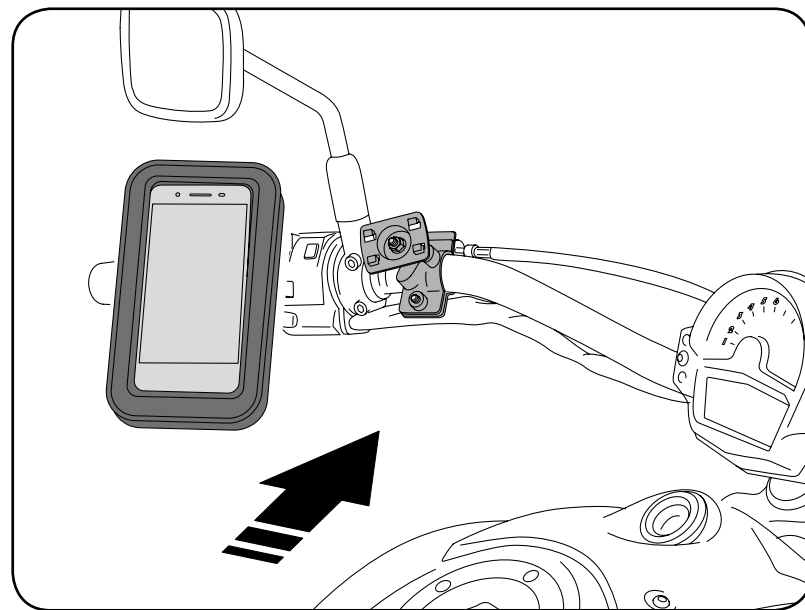

This element allows you to directly adjust the support for the Smartphone to the handlebar of the motorcycle. It is made out of two halves that attach to each other with the handlebar in between, while they adjust through a thumbscrew. We also offer different thickness rubber spacers, so that it ends up perfectly adjusted to the motorcycle.

This part is good for any handlebar that has a diameter of Ø20 until Ø25 mm and just like any of our supports, it is compatible with our cel phone covers.



N
Black



MODEL	PART#	N
HANDLEBAR BRACKET	3534N	(*)

(*) Check the price with your distributor.
IMPORTANT: Indicate code color after part#. Example: 0973A

// REARVIEW MIRROR BASE

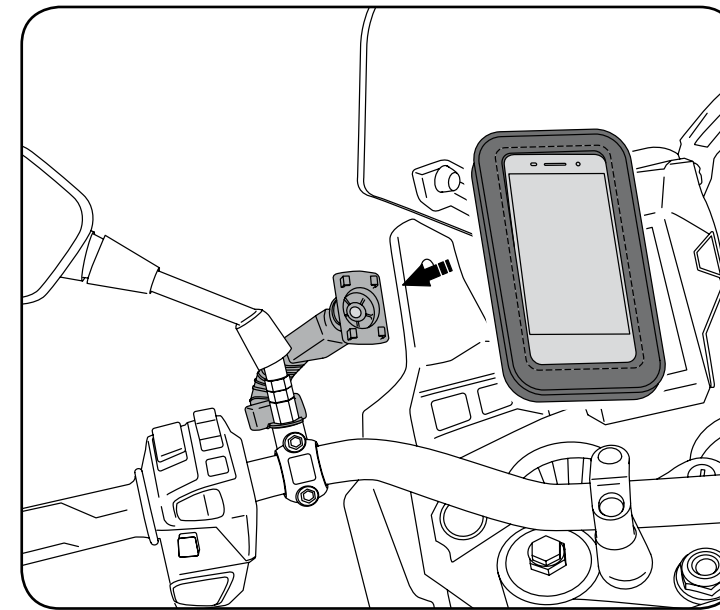

Support for the rearview mirror base, it is an universal support with complete mobility, 360° and also allows 100% adjustability to guarantee the best view during the ride, so the rider doesn't lose focus of the road.

The support is made of a metal base and a semi-rigid arm that guarantees a perfect attachment to the base of the rearview mirror. This support is good for all those motorcycle models that carry the rearview mirrors over the handlebars and are also compatible with Puig's covers.



MODEL	PART#	N
REARVIEW BASE SUPPORT	3532N	(*)

// REARVIEW MIRROR ROD

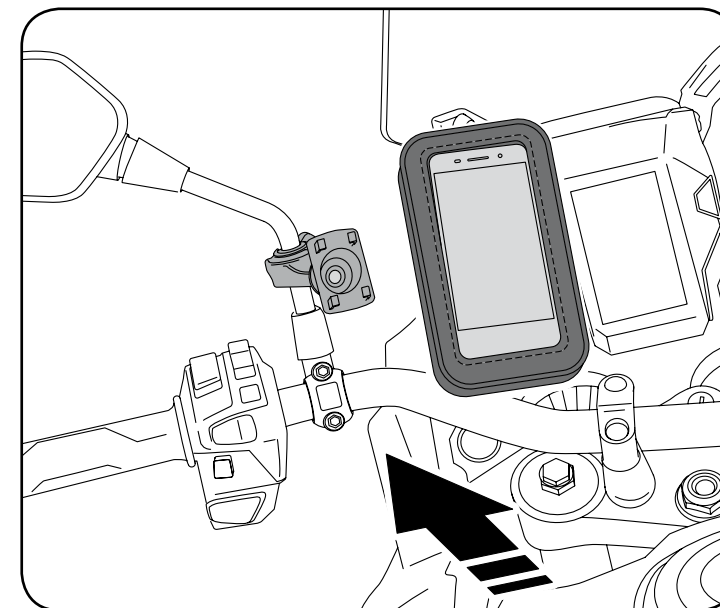

A support of easy and quick application, where the plastic cover hugs the rearview mirror rod and it is attached by a thumbscrew. It is offered with different rubber spacers, of different thickness, to adapt it to the different motorcycles needs.

This support is good for mounting over any rearview mirror with a cylindrical rod of Ø0 until Ø25 and just like the last one it is compatible with our covers.



MODEL	PART#	N
REARVIEW MIRROR SUPPORT	3533N	(*)



N
Black

(*) Check the price with your distributor.
IMPORTANT: Indicate code color after part#. Example: 0973A



KICKSTAND EXTENSION

HI-TECH PARTS | TECHNICAL SECTION



DESIGN
Kickstand larger base extension.

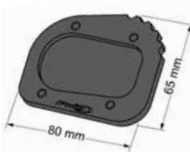

MEASUREMENTS

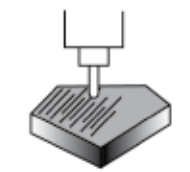

MACHINED
Machined from a billet aluminium block and anodized in colors.



WEIGHT
90 grams



N
Black



FRAME SLIDERS R19 MODEL

HI-TECH PARTS | TECHNICAL SECTION

BODY

Nylon pucks in black colour.



RUBBER

Protects rider's knee from possible hits while getting on the bike. Supplied in grey color.

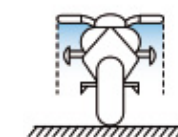

DESIGN

Sliders do not stand out from handlebar and touch after the footpegs.



COMPLETE PROTECTION

Protect engine and chassis.

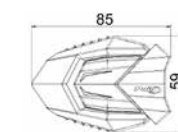

DIMENSIONS

// RUBBER ENDS AVAILABLE IN VARIOUS COLORS

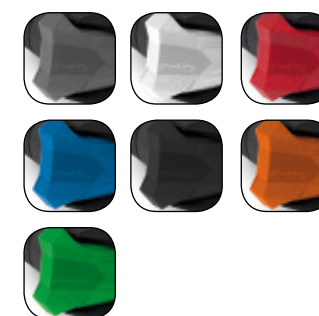

SPARES RUBBERS	PART#	UBRVANT
RUBBER END PROTECTOR R19 BY PAIR	3148	(*)

SPARE PUCKS	PART#	N
NYLON PUCKS + RUBBER END C/GREY BY PAIR MOD. R19 OF 85 mm. FOR SCREW M10	3149	(*)
NYLON PUCKS + RUBBER END C/GREY BY PAIR MOD. R19 OF 85 mm. FOR SCREW M12	3150	(*)
NYLON PUCKS + RUBBER END C/GREY BY PAIR MOD. R19 OF 50 mm. FOR SCREW M10	3151	(*)
NYLON PUCKS + RUBBER END C/GREY BY PAIR MOD. R19 OF 50 mm. FOR SCREW M12	3152	(*)

SPARE PUCKS VINTAGE	PART#	N
NYLON STOP VINTAGE FOR M10 SCREW (COMPATIBLE WITH TOP19 R19)	3153	(*)
VINTAGE NYLON STOP FOR M12 SCREW (COMPATIBLE WITH TOP19 R19)	3154	(*)

(*) Check the price with your distributor.
IMPORTANT: Indicate code color after part#. Example: 0973A

HEADQUARTERS

MOTOPLASTIC, S.A.
Passeig de la Ribera, nº29
08403 Granollers
Spain

Tel. +34 938490633

Fax +34 938490988

info@puig.tv

UNITED STATES

PUIG USA INC.
3843 St. Valentine Way
Orlando, FL 32811
Ph. +1 407.237.0207
info@puigusa.com

AGENT POUR LA FRANCE - ARTECH

Zac du long Buisson
180 Rue Clement Ader
Batiment 1
27000 Evreux
Tel. 02.32.305.305
Fax 02.32.305.306
Puig.artech@orange.fr

Puig
Hi-Tech Parts

W W W . P U I G . T V