

2.0 MULTI-ADJUSTABLE VISOR (FIX)

M O U N T I N G I N S T R U C T I O N S

REF 20763

UNIVERSAL (FIXED VERSION)



1 Person

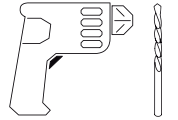

Ø7



15 min



PHILLIPS
SCREWDRIVER



EASY

ALLEN
Nº 4



ID	PIEZA/PART	DESCRIPCIÓN	DESCRIPTION	QTY	REF
1		Visera de policarbonato antirayadas	Antiscratch polycarbonate Visor	1	20765H/WM3
2		Plantilla	Template	1	PLANTILLA-VISOR
3		Mecanismo Izquierdo	Left Mechanism	1	See exploding page 2
4		Mecanismo Derecho	Right Mechanism	1	See exploding page 2

2.0 MULTI-ADJUSTABLE VISOR (FIX)

INSTRUCCIONES DE MONTAJE - MOUNTING INSTRUCTIONS - MONTAGEANLEITUNG

1

EXPLOTING

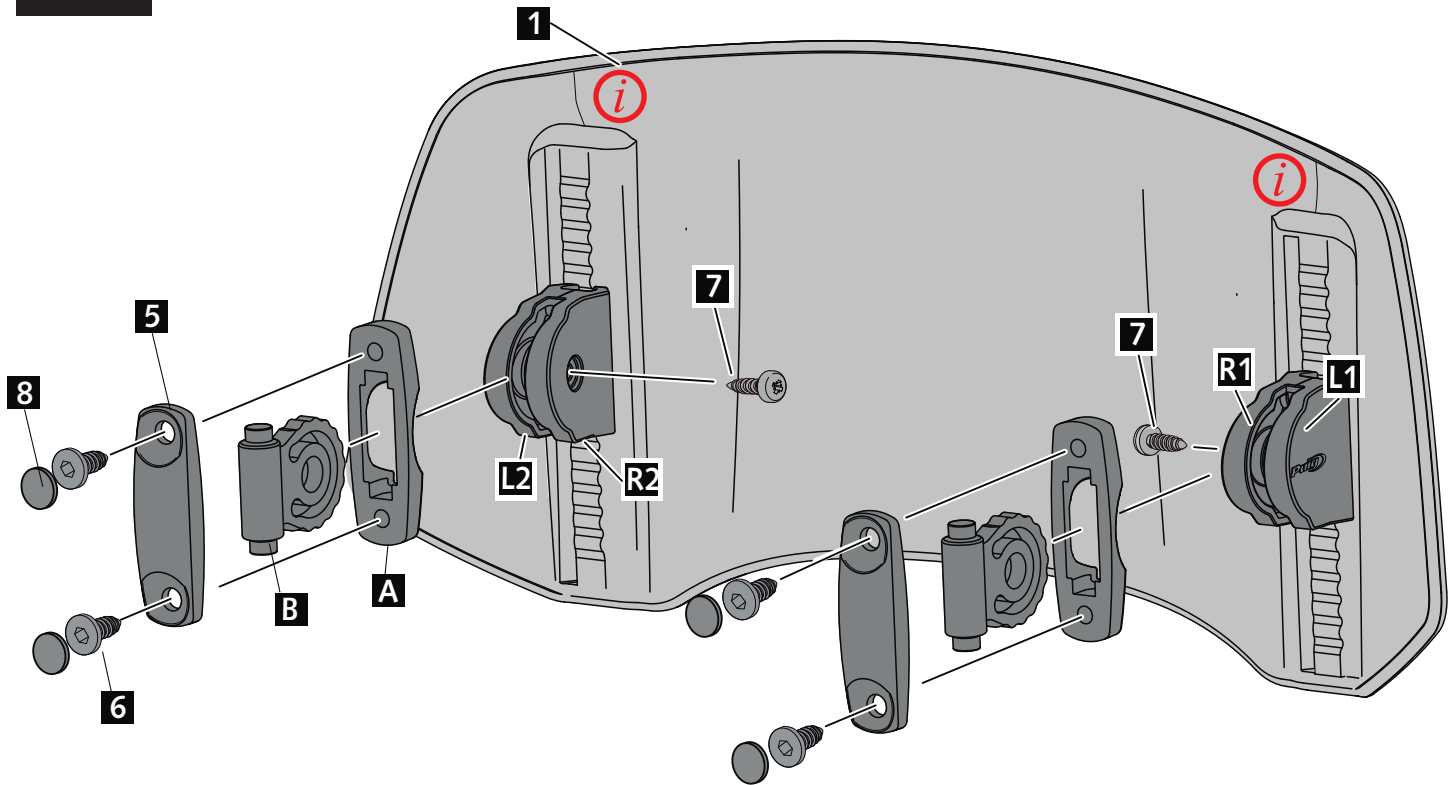

i LINEA DE PARTICIÓN DEL MOLDE DE INYECCIÓN. PARTING LINE OF THE INJECTION MOLD **i**

ID	PIEZA/PART	DESCRIPCIÓN	DESCRIPTION	QTY	REF
A		Tapa pieza eje	Axle part cover	2	TAPAEJE-VISOR--
B		Pieza eje	Axle part	2	EJE-FIX-VISOR--
L2		Tapa 2 Logo	Logo cover 2	1	TAPALAT-VISORL2
R2		Tapa 2 Tornillo	Screw cover 2	1	TAPALAT-VISORR2
L1		Tapa 1 Logo	Logo cover 1	1	TAPALAT-VISORL1
R1		Tapa 1 Tornillo	Screw cover 1	1	TAPALAT-VISORR1
5		Tapa cúpula	screen cover	2	TAPAFIX-VISOR--
6		Tornillo allen S.T. 6,3 x14	S.T. 6,3 x14 Allen screw	4	TOZN00M60000258
7		Tornillo Ø3,5x9,5 DIN7981 C (negro)	Ø3,5x9.5 DIN7981 C screw (black)	2	TORNI-D7981-907
8		Tapón tornillo M6	M6 Screw cap	4	TAPON-----81

2.0 MULTI-ADJUSTABLE VISOR (FIX)

INSTRUCCIONES DE MONTAJE - MOUNTING INSTRUCTIONS - MONTAGEANLEITUNG

2

ASSEMBLY
MONTAJE

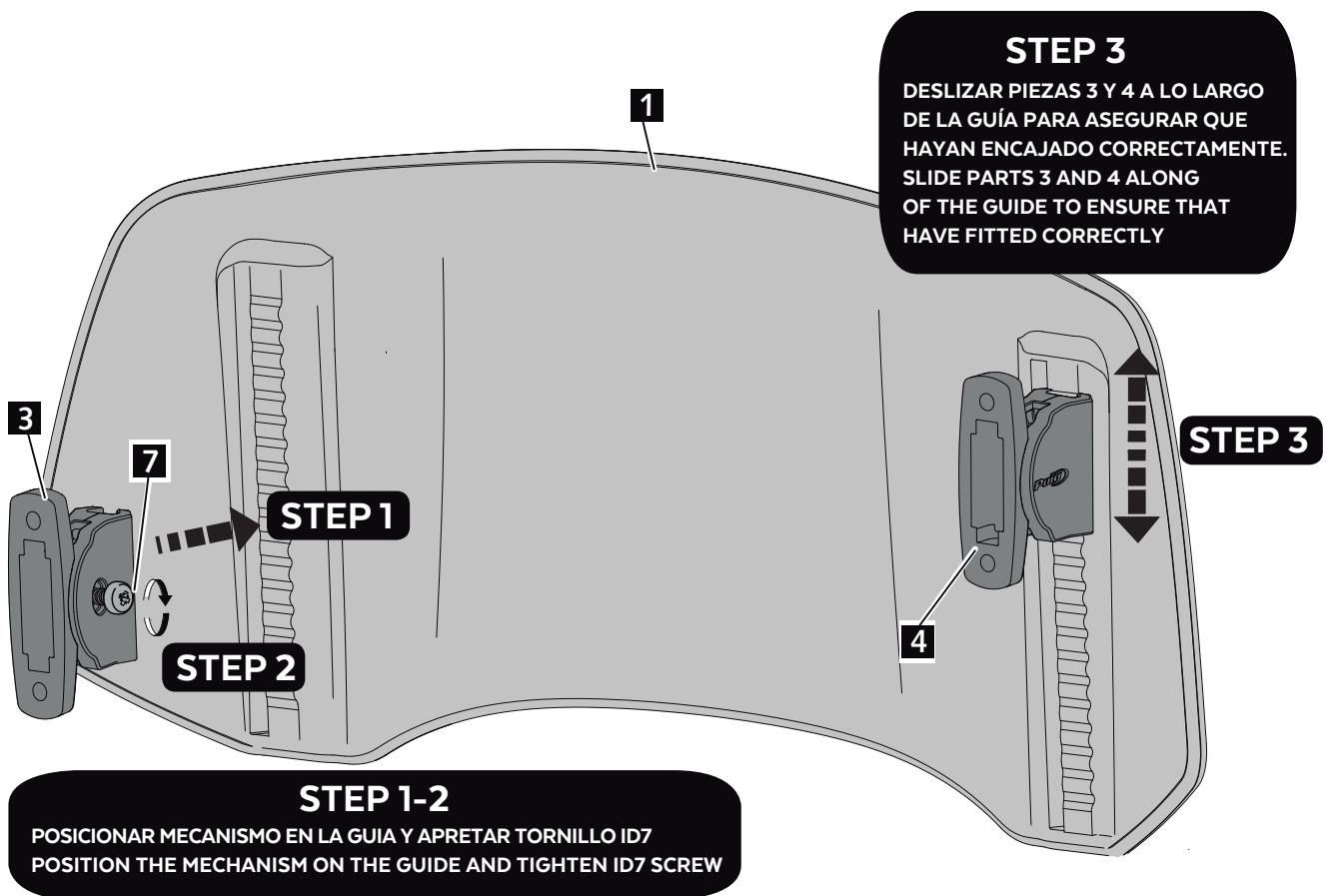

PAR APRIETE TORNILLO ID7 1 Nm
TIGHTENING TORQUE FOR ID7 SCREW 1 Nm

2.0 MULTI-ADJUSTABLE VISOR (FIX)

INSTRUCCIONES DE MONTAJE - MOUNTING INSTRUCTIONS - MONTAGEANLEITUNG

3

SCREEN TYPE “ ——— ”

ASSEMBLY
MONTAJE

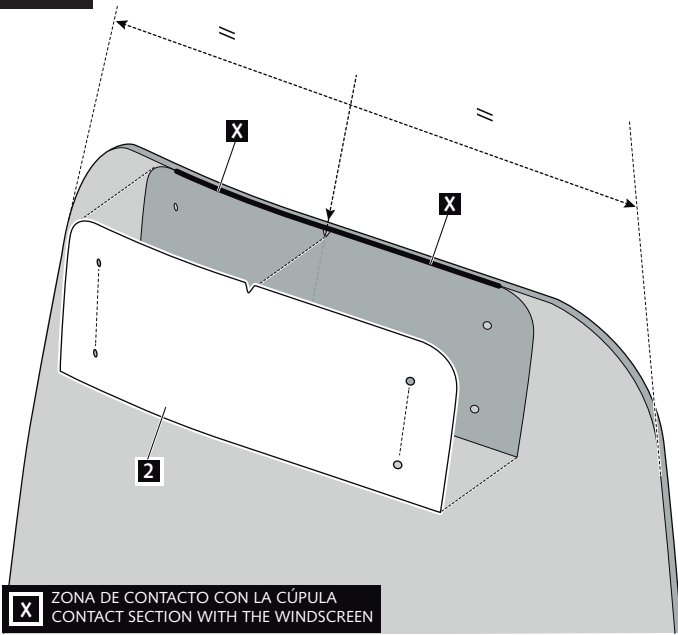

SCREEN TYPE “ ——— ”

3

ASSEMBLY
MONTAJE

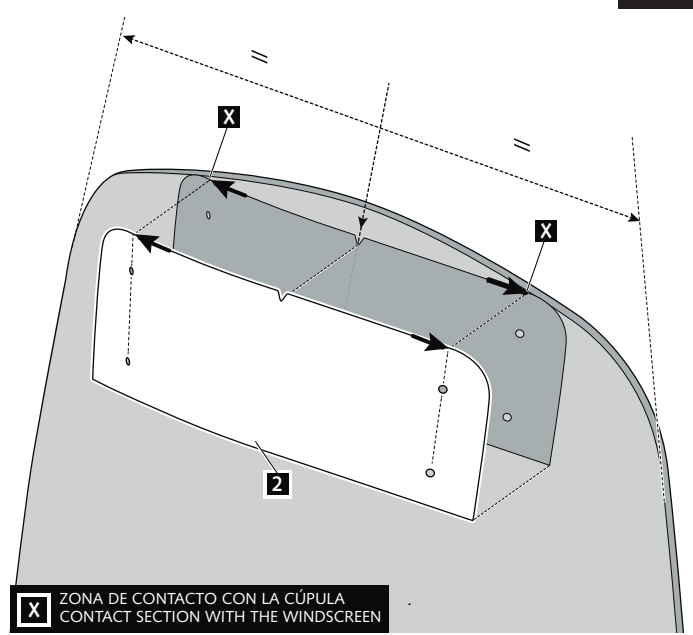

3

SCREEN TYPE “ ——— ”

ASSEMBLY
MONTAJE

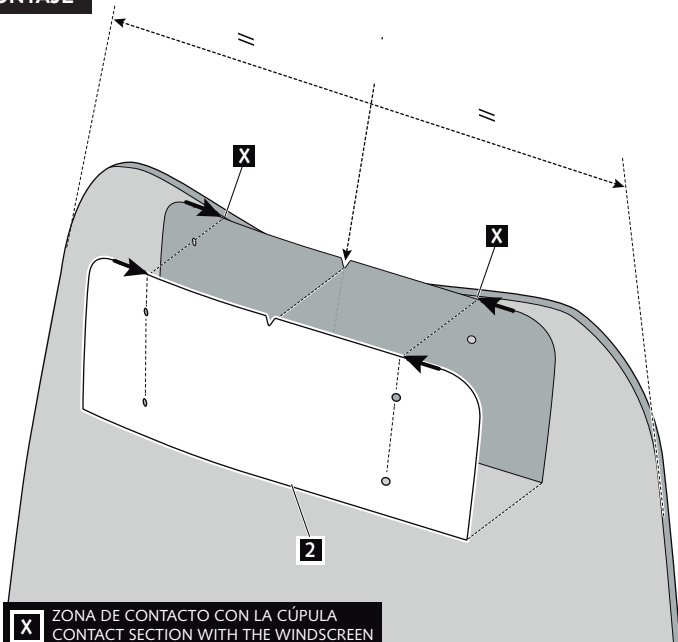

4

ASSEMBLY
MONTAJE

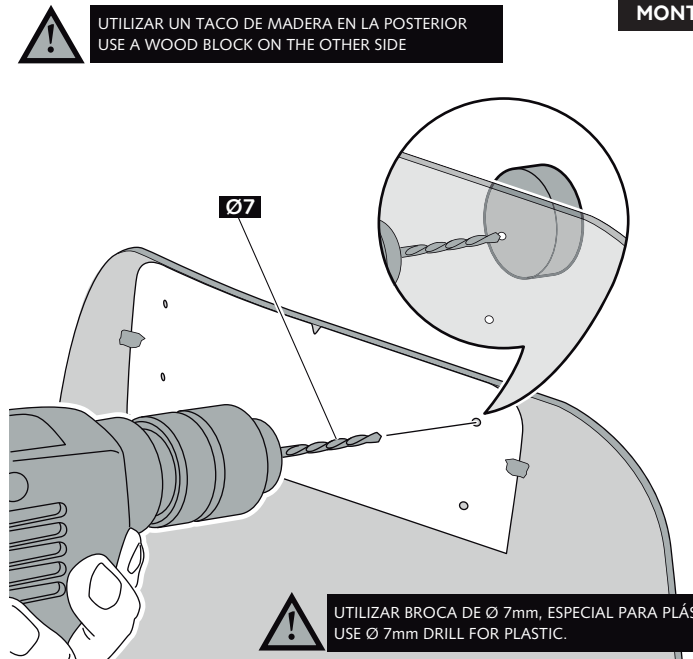

UTILIZAR UN TACO DE MADERA EN LA POSTERIOR
USE A WOOD BLOCK ON THE OTHER SIDE

UTILIZAR BROCA DE Ø 7mm, ESPECIAL PARA PLÁSTICO.
USE Ø 7mm DRILL FOR PLASTIC.

2.0 MULTI-ADJUSTABLE VISOR (FIX)

INSTRUCCIONES DE MONTAJE - MOUNTING INSTRUCTIONS - MONTAGEANLEITUNG

5

ASSEMBLY
MONTAJE

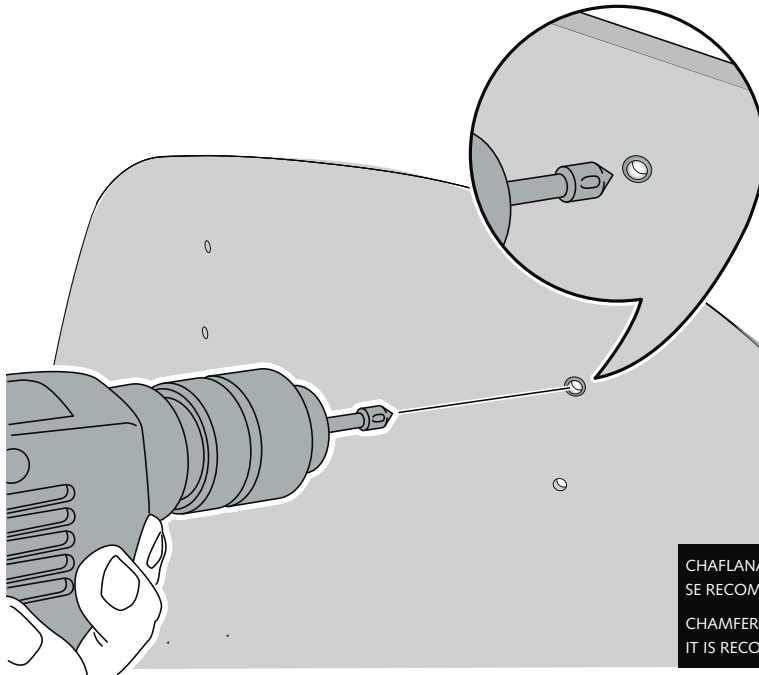

CHAFLANAR LOS 4 AGUJEROS POR AMBOS LADOS.
SE RECOMIENDA REALIZAR CHAFLAN $\varnothing 10\text{mm} - \varnothing 20\text{mm}$
CHAMFER THE FOUR HOLES ON BOTH SIDES.
IT IS RECOMMENDED TO MAKE CHAMFER $\varnothing 10\text{mm} - \varnothing 20\text{mm}$

6

ASSEMBLY
MONTAJE

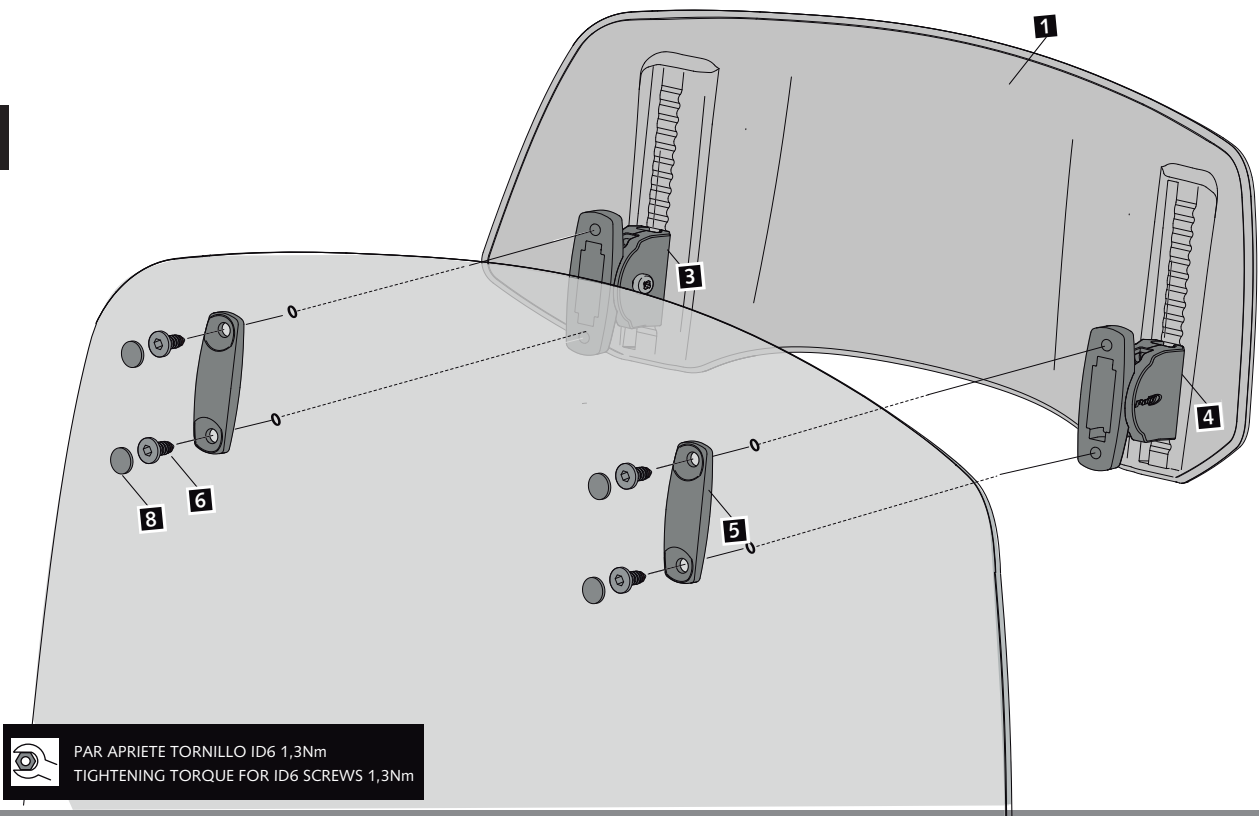

PAR APRIETE TORNILLO ID6 1,3Nm
TIGHTENING TORQUE FOR ID6 SCREWS 1,3Nm