

HONDA CB650R '19

REF 3528N

SOPORTE INTERMITENTE / TURN SIGNAL SUPPORT / BLINKENDE HALTER



1 Person







40 min

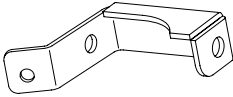

EASY



ID.	PIEZA / PART	DESCRIPCIÓN	DESCRIPTION	QTY.	REF.:
1		Soporte	Support	2	INTDELO3-0-003
2		Tornillo M6x15 DIN912	M6x15 DIN912	2	TORNI-AD912-430
3		Arandela M6	M6 washer	2	ARANDEP125-054
4		Tuerca M6 DIN6923	M8 DIN6923 nut	2	TUERCAEM6G-0213

**CONSULTAR EN NUESTRA PAGINA WEB LA DISPONIBILIDAD DEL VIDEO DE MONTAJE DE ESTA REFERENCIA.
CONSULT OUR WEBSITE THE VIDEO MOUNT AVAILABILITY OF THIS REFERENCE.**



HONDA CB650R '19

REF 3528N

INSTRUCCIONES DE MONTAJE - MOUNTING INSTRUCTIONS - MONTAGEANLEITUNG

1

DISASSEMBLY
DESMONTAJE

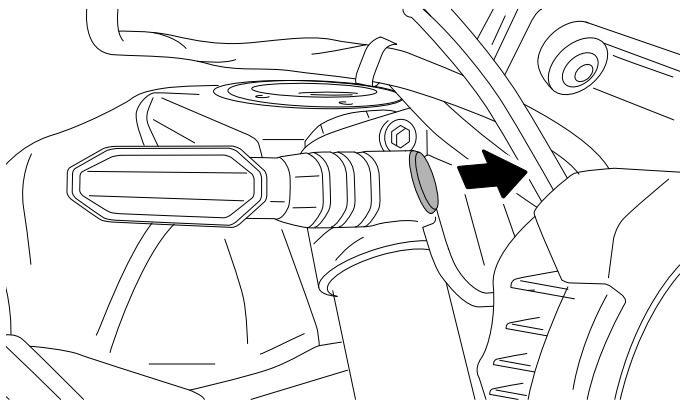

QUITAR TAPA /
REMOVE COVER

2

DISASSEMBLY
DESMONTAJE

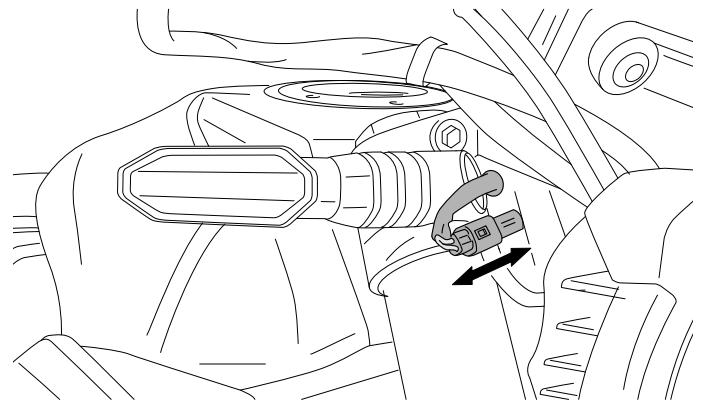

DESCONECTAR /
DISCONNECT

3

DISASSEMBLY
DESMONTAJE

A Componentes originales
Original components

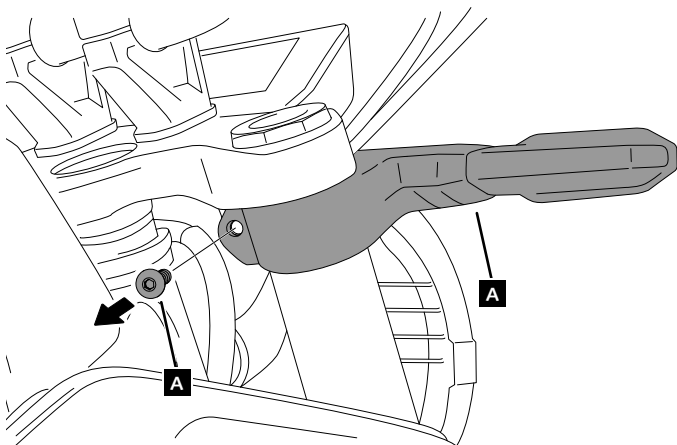

4

ASSEMBLY
MONTAJE

