

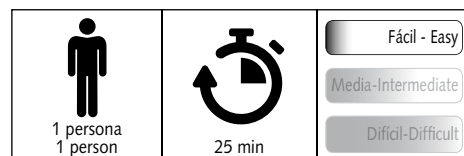

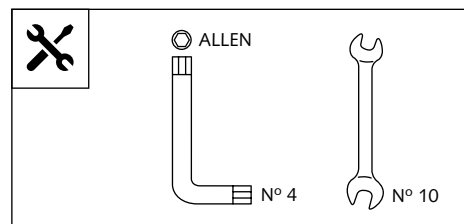

CÚPULA TOURING PARA - TOURING SCREEN FOR - TOURENSCHEIBE FÜR BENELLI TRK 502

Ref.: 9485

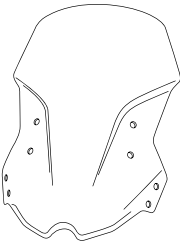

ID	PIEZA / PART	DESCRIPCIÓN	DESCRIPTION	QTY	REF.
1		Cúpula Touring	Touring screen	1	9485F/H/WM3
2		Arandela metálica Ø18x Ø6,5 x1,6	Metallic washer Ø18x Ø6,5 x1,6	4	ARANDPD9021-037
3		Silentblock Ø22x Ø9 x8 (se suministra montado)	Ø22x Ø9 x8 silentblock (supplied already mounted)	4	SILENB000000036
4		Casquillo con valona Ø15 xØ9 x7,5 (se suministra montado)	Ø15 xØ9 x7,5 bush with flange (supplied already mounted)	4	CASQUI-1A---324

CÚPULA TOURING PARA - TOURING SCREEN FOR - TOURENSCHEIBE FÜR
BENELLI TRK 502

INSTRUCCIONES DE MONTAJE - MOUNTING INSTRUCTIONS - MONTAGEANLEITUNG

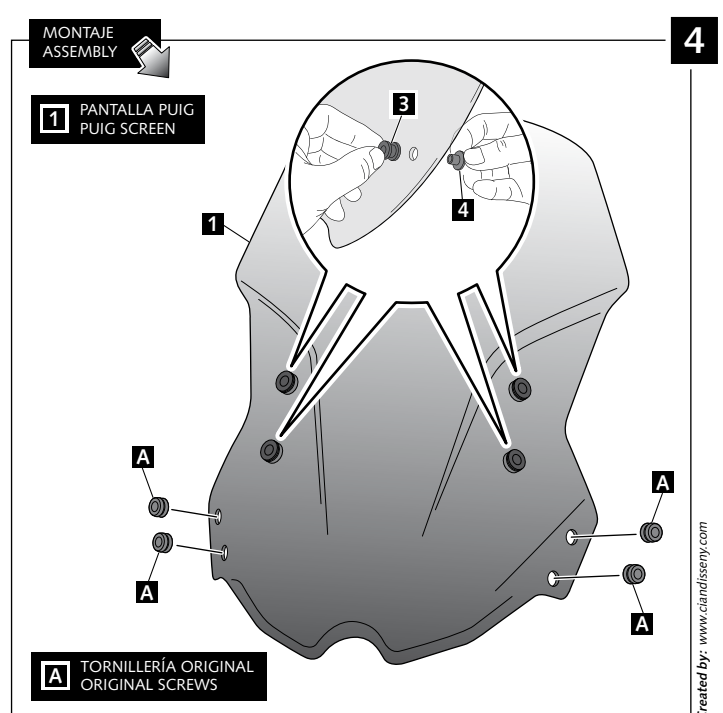
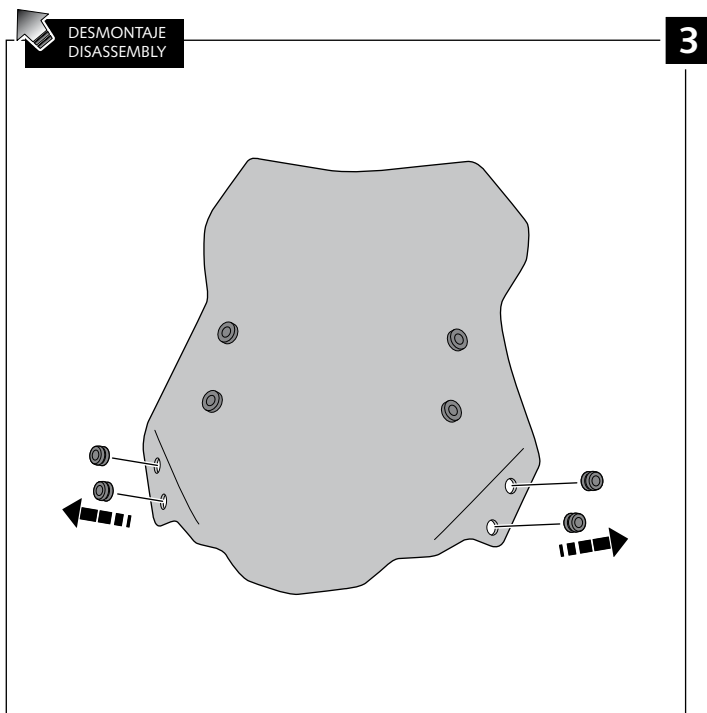
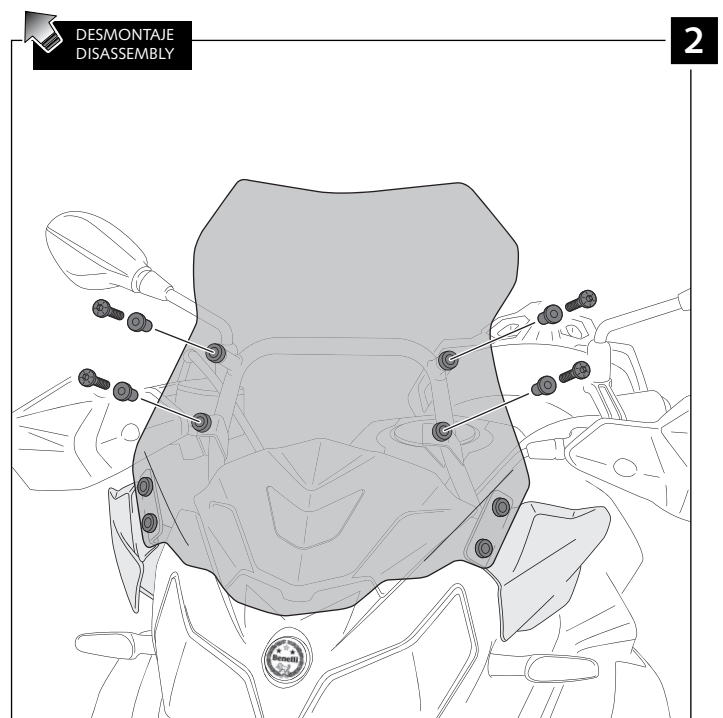
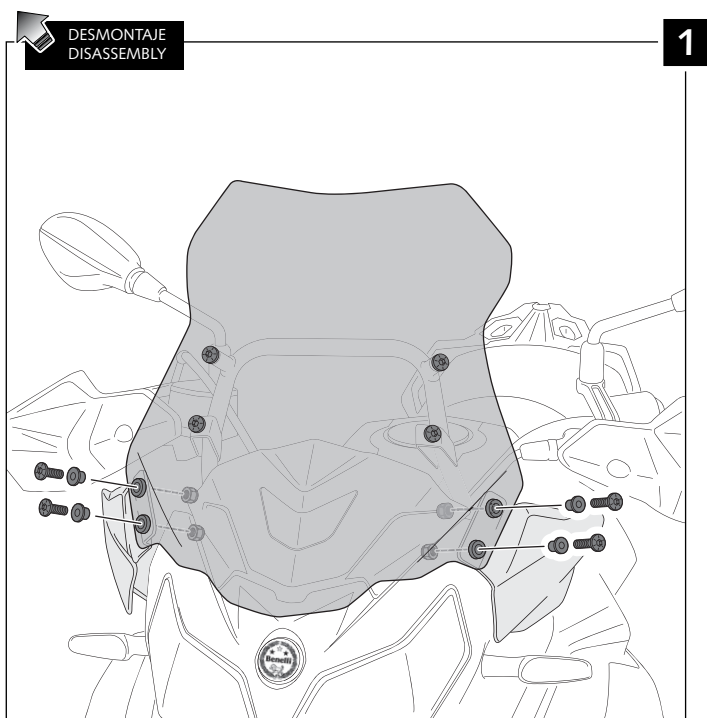

CÚPULA TOURING PARA - TOURING SCREEN FOR - TOURENSCHEIBE FÜR
BENELLI TRK 502

INSTRUCCIONES DE MONTAJE - MOUNTING INSTRUCTIONS - MONTAGEANLEITUNG

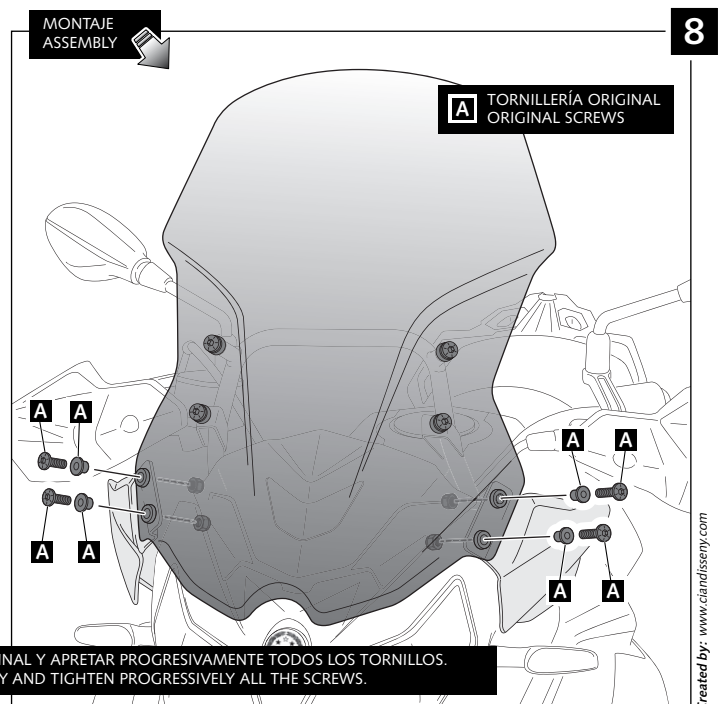
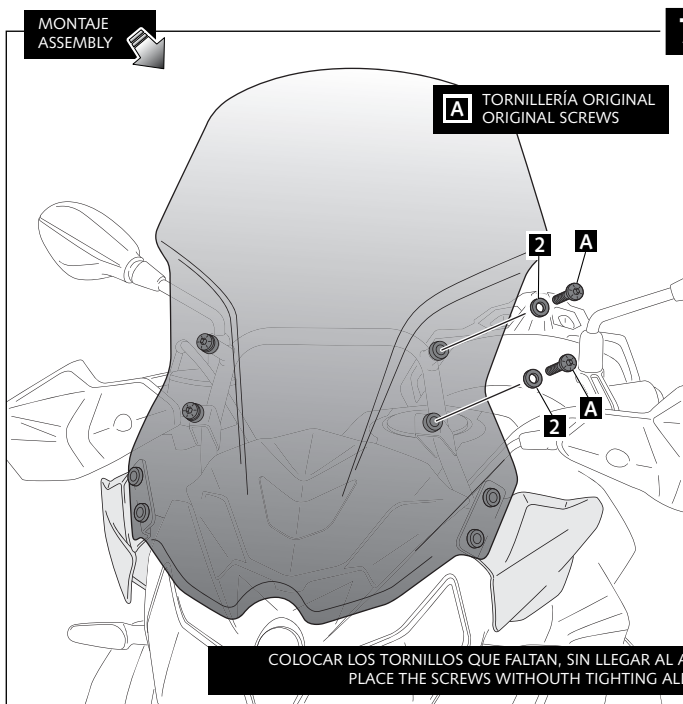
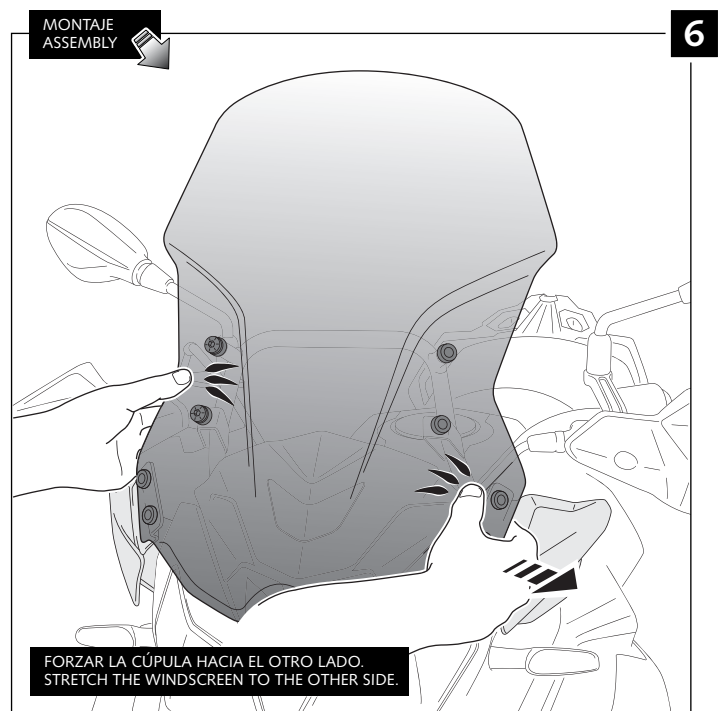
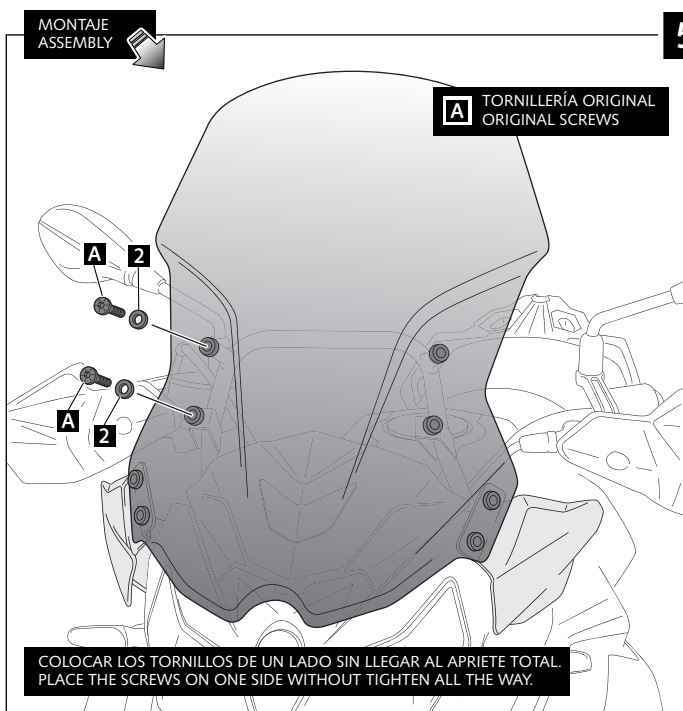

VISERA MULTIREGULABLE MULTI-ADJUSTABLE VISOR

CÚPULA TIPO
TYPE WINDSCREEN **A**



CÚPULA TIPO
TYPE WINDSCREEN **B**



CÚPULA TIPO
TYPE WINDSCREEN **C**



Ref.: 6007

Ref.: 5852

Ref.: 5853

Ahumado/Smoke

Transparente/Clear

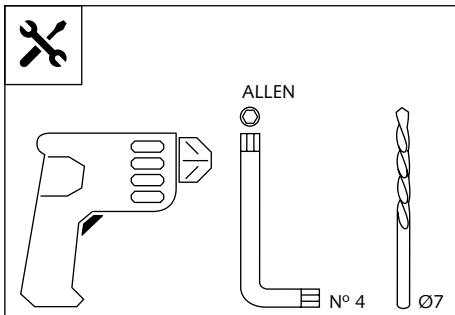

1 persona
1 person



15 min

Fácil - Easy

Media-Intermediate

Difícil-Difficult

Nota/Note:

Si la visera se suministra con la cúpula Puig, no será necesario realizar los agujeros por que ya vienen incorporados.

If the visor is supplied along with the windscreen, the windscreen will come factory-drilled so no drilling is necessary.

ID.	PIEZA / PART	DESCRIPCIÓN	DESCRIPTION	QTY.
1		Visera	Visor	1
2		Plantilla	Template	1
3		Mecanismo multiregulable	Multi-adjustable mechanism	2
4		Tapeta	Cap	4
5		Tornillo rosca plástico M6x12	Plastic thread fastener M6x12	8

VISERA MULTIREGULABLE MULTI-ADJUSTABLE VISOR

INSTRUCCIONES DE MONTAJE - MOUNTING INSTRUCTIONS - MONTAGEANLEITUNG

TIPO/TYPER A - TIPO/TYPER A - TIPO/TYPER A

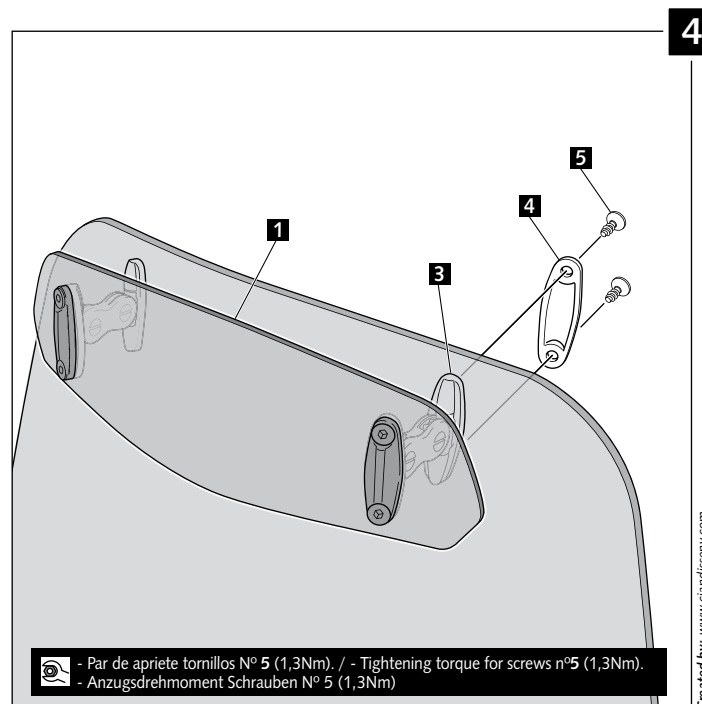
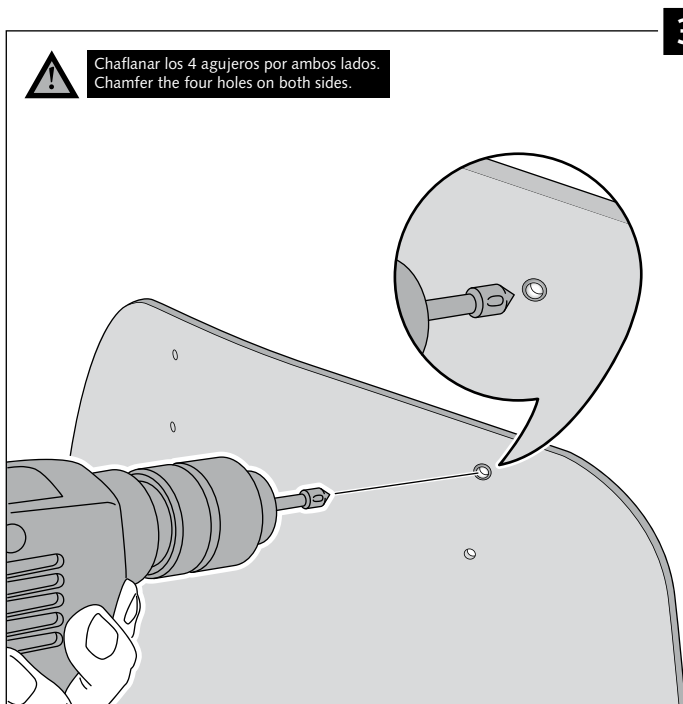
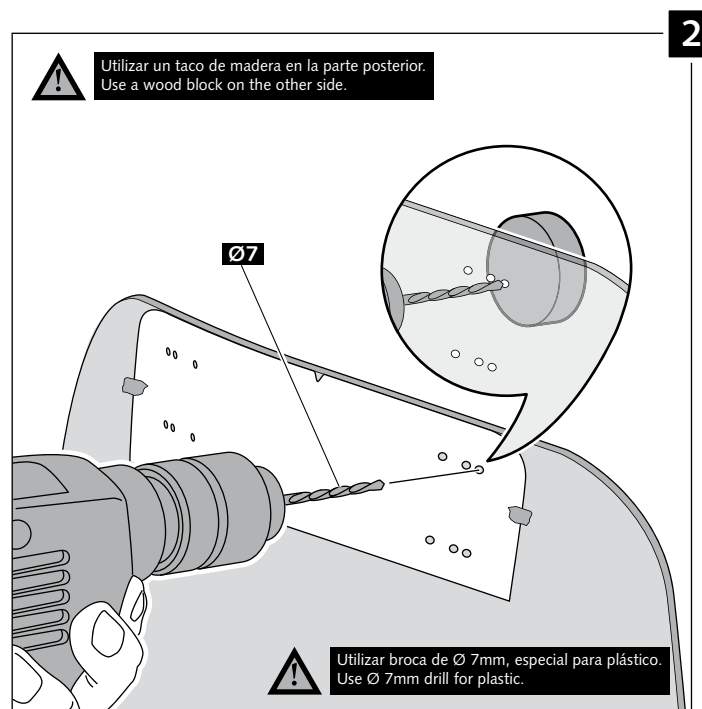
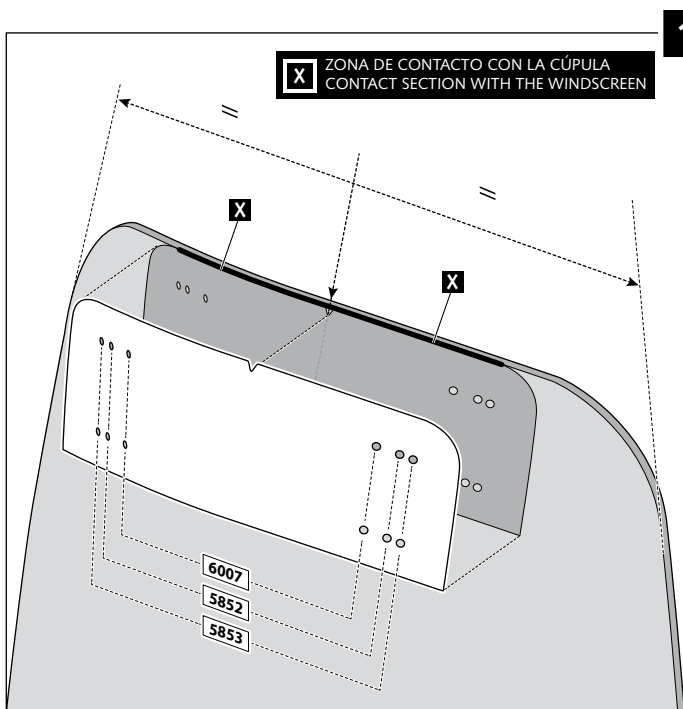

VISERA MULTIREGULABLE MULTI-ADJUSTABLE VISOR

INSTRUCCIONES DE MONTAJE - MOUNTING INSTRUCTIONS - MONTAGEANLEITUNG

TIPO/TYPE B - TIPO/TYPE B - TIPO/TYPE B

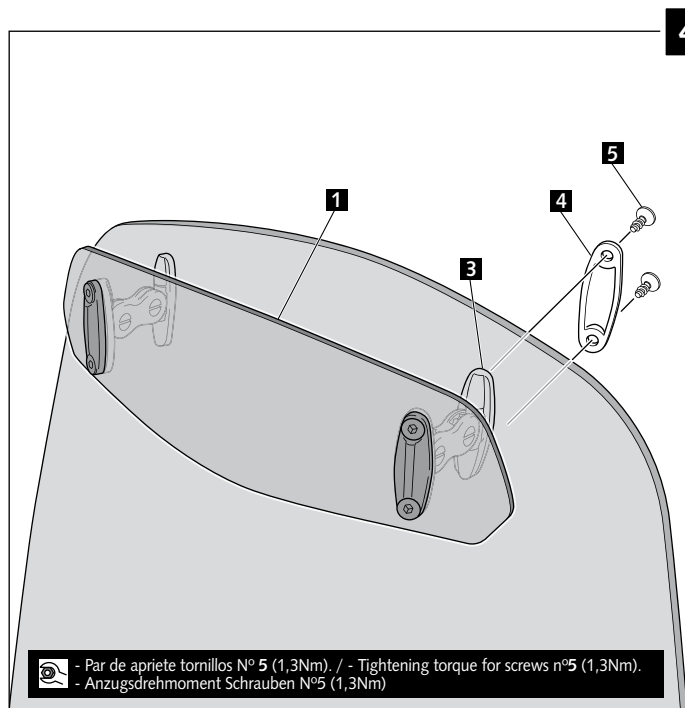
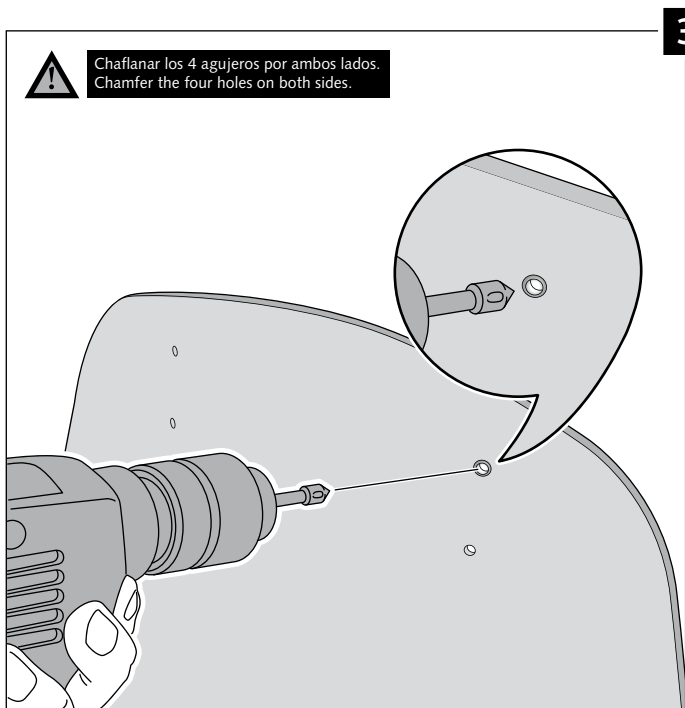
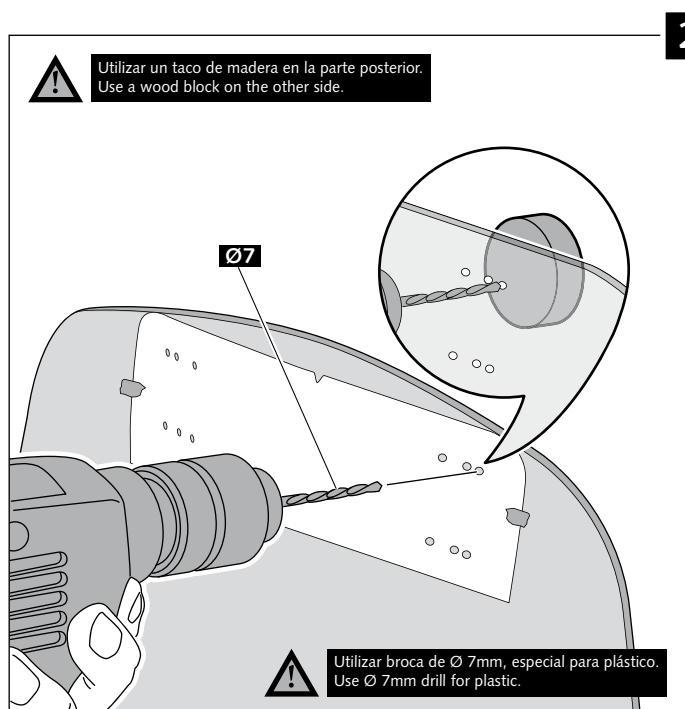
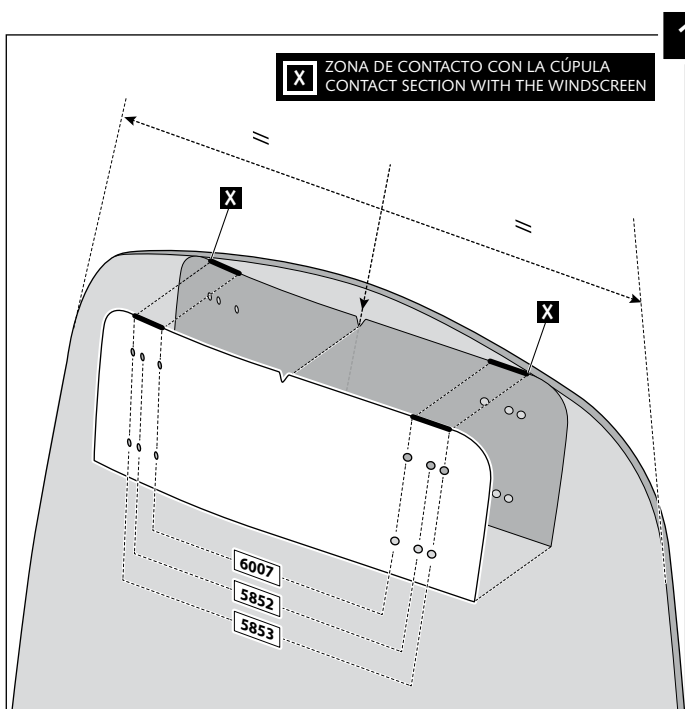

VISERA MULTIREGULABLE MULTI-ADJUSTABLE VISOR

INSTRUCCIONES DE MONTAJE - MOUNTING INSTRUCTIONS - MONTAGEANLEITUNG

TIPO/TYPER C - TIPO/TYPER C - TIPO/TYPER C

