

# CF MOTO NK 450 '24-

## MOUNTING INSTRUCTIONS

REF 21884N

PROTECTOR BASCULANTE PHB19 / PHB19 PROTECTOR SWINGARM

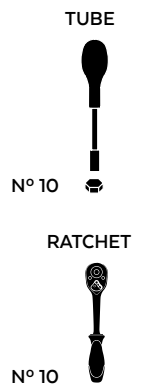

ID.	PIEZA / PART	QTY.	REF.:
1		1	PROBAS82-0-0082
2		1	PROBAS81-0-0081
3		1	VARIFO09-1-0009
4		2	TUZBM6000000024
5		2	ARANDEPD125-054
6		2	TAPAFINALR17-18

# CF MOTO NK 450 '24-

REF  
21884N

INSTRUCCIONES DE MONTAJE - MOUNTING INSTRUCTIONS - MONTAGEANLEITUNG

**1**

ASSEMBLY  
MONTAJE

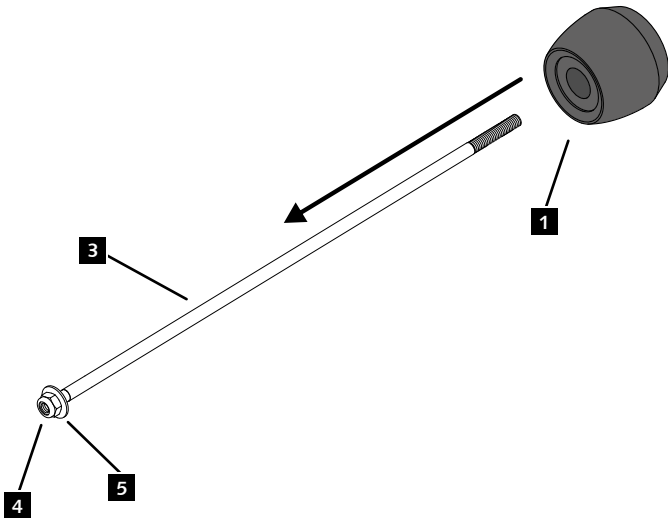

**2**

ASSEMBLY  
MONTAJE

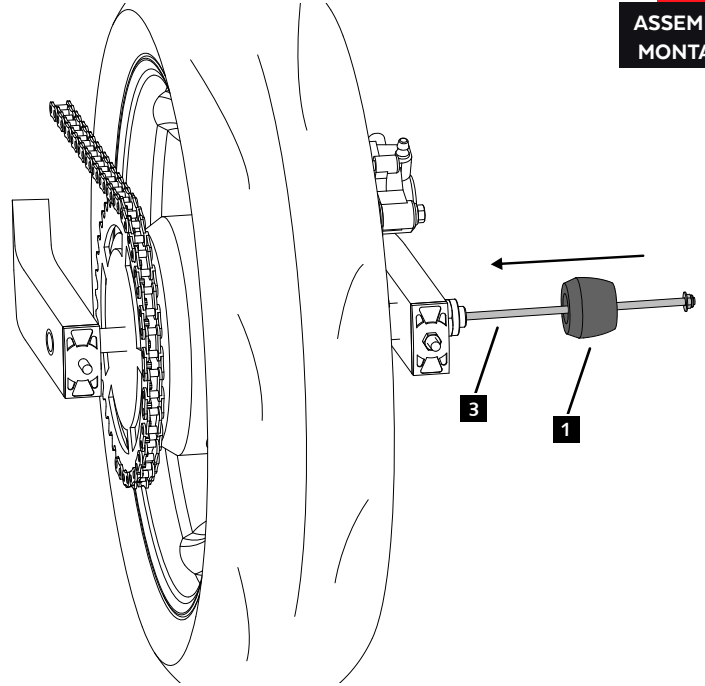

**3**

ASSEMBLY  
MONTAJE

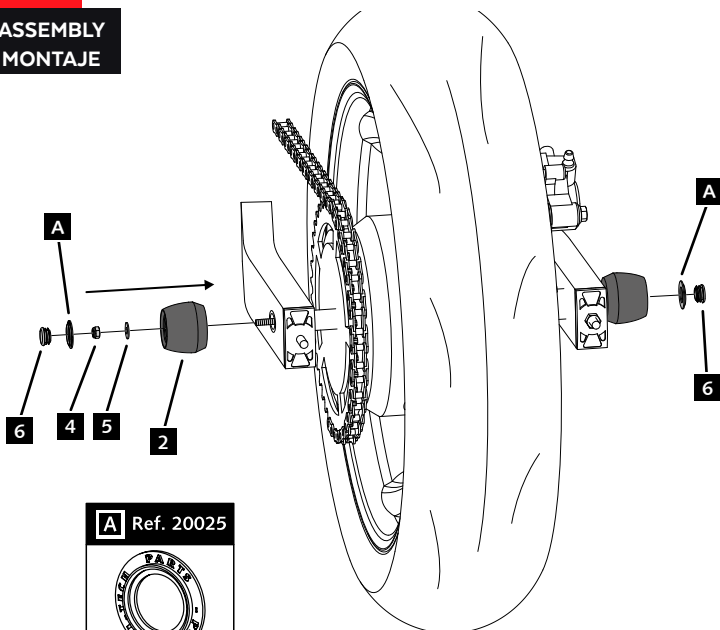

**A** Ref. 20025



**4**



9.7 N/m - Par de apriete  
86 lbf/in - Tightening torque

CONSULTAR EN NUESTRA PAGINA WEB LA  
DISPONIBILIDAD DEL VIDEO DE MONTAJE DE  
ESTA REFERENCIA.  
CONSULT OUR WEBSITE THE VIDEO MOUNT  
AVAILABILITY OF THIS REFERENCE.

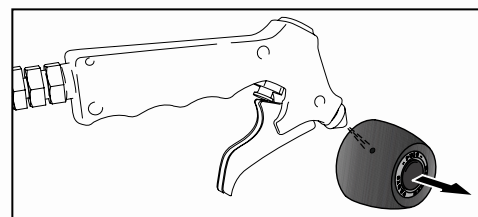

**6** Extracción del tapón / Removing the cap