

## CARENABRÍS UNIVERSAL MODELO / UNIVERSAL WINDSHIELD MODEL / UNIVERSAL WINDSCHUTZSCHEIBE MODEL UP & DOWN

Ref.: 2193

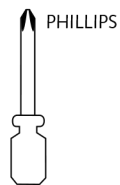

1 persona  
1 person

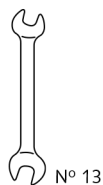

25 min

Fácil - Easy

Media-Intermediate

Difícil-Difficult

## CARENABRÍS UNIVERSAL MODELO / UNIVERSAL WINDSHIELD MODEL / UNIVERSAL WINDSCHUTZSCHEIBE MODEL UP & DOWN

### INSTRUCCIONES DE MONTAJE - MOUNTING INSTRUCTIONS - MONTAGEANLEITUNG

MONTAJE  
ASSEMBLY

1

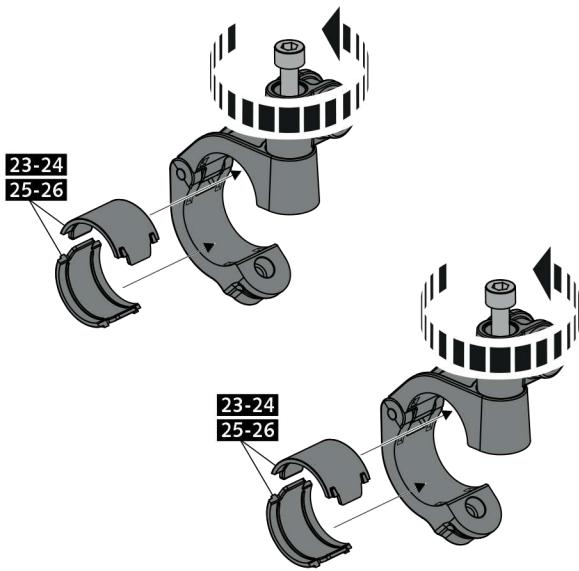

MONTAJE  
ASSEMBLY

2

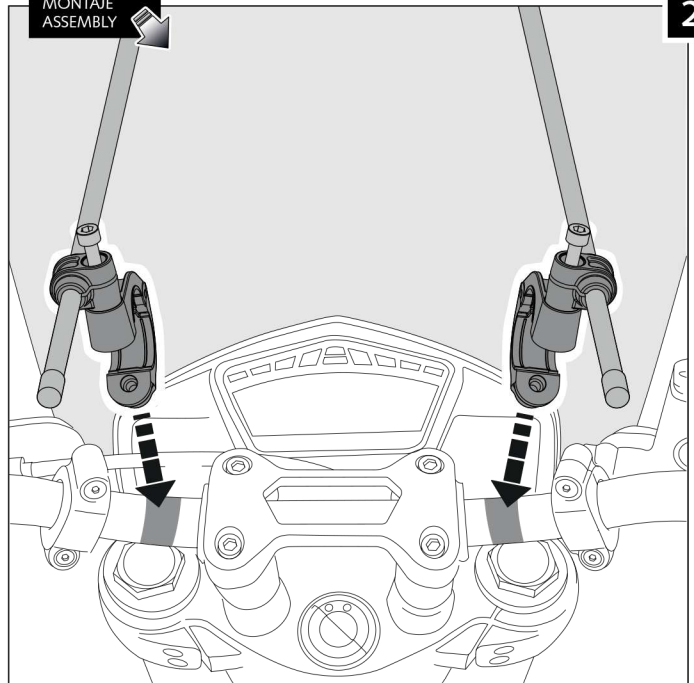

MONTAJE  
ASSEMBLY

3

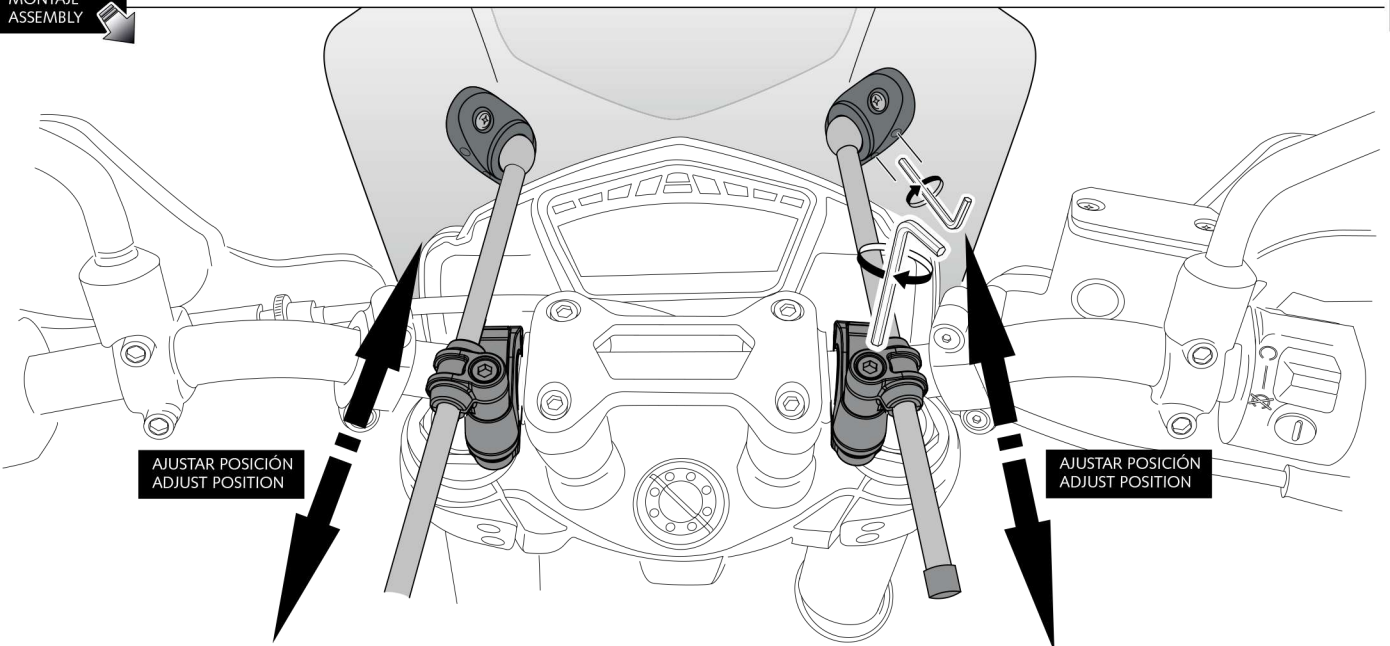

## CARENABRÍS UNIVERSAL MODELO / UNIVERSAL WINDSHIELD MODEL / UNIVERSAL WINDSCHUTZSCHEIBE MODEL

# UP & DOWN

### MONTAJE OPCIONAL DE SOPORTES DE REFUERZO MOUNTING FOR OPTIONAL REINFORCEMENT BRACKETS OPTIONALE MONTAGE VON VERSTÄRKUNGHALTERUNGEN

MONTAJE  
ASSEMBLY

1

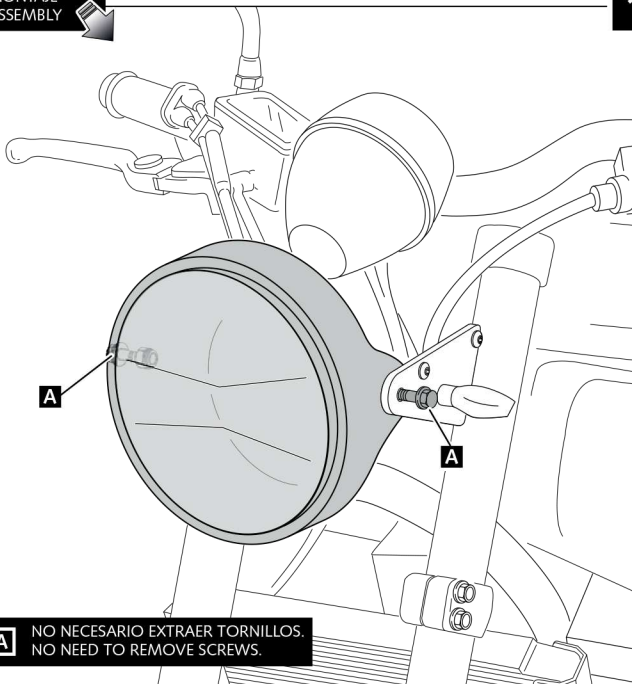

MONTAJE  
ASSEMBLY

2

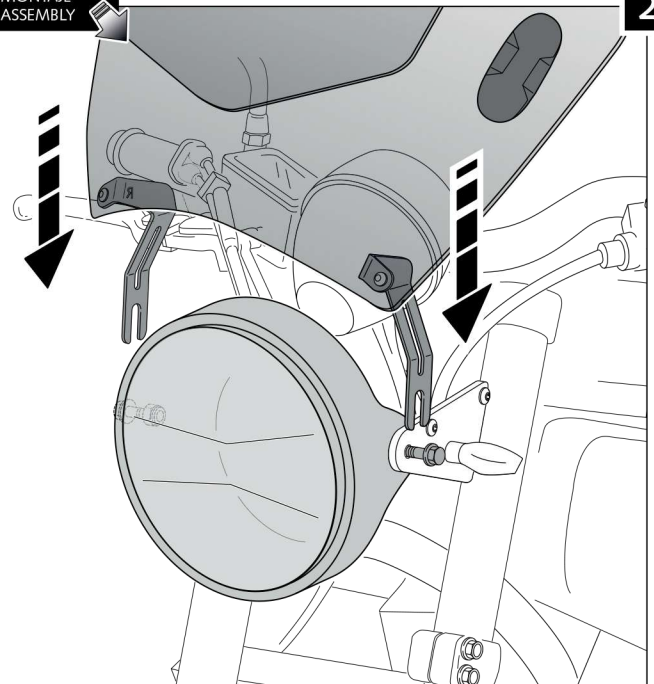

MONTAJE  
ASSEMBLY

3

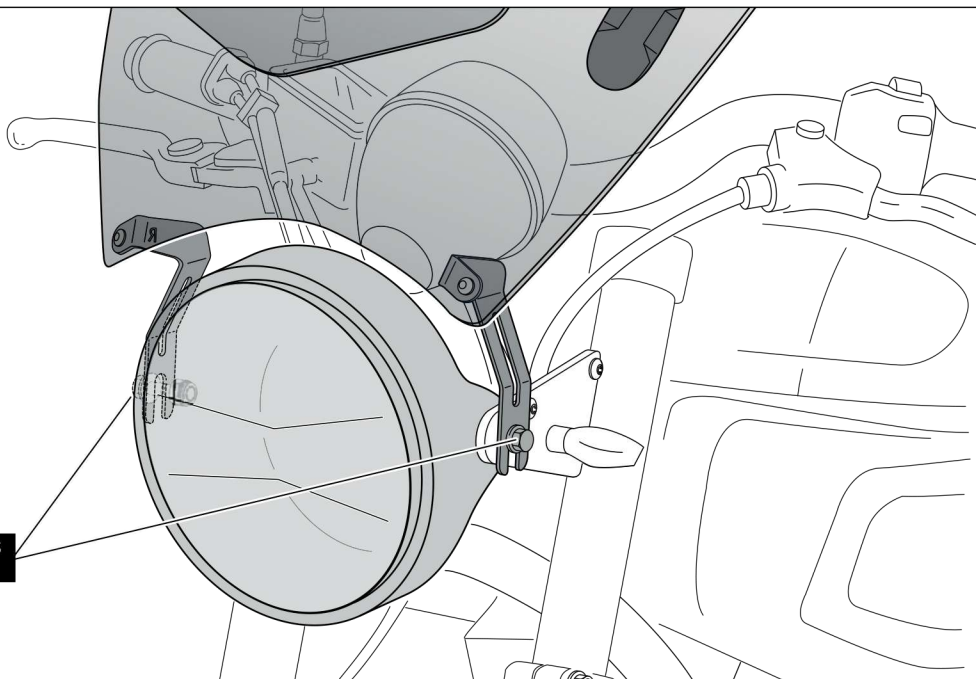

APRETAR LOS TORNILLOS  
TIGHTEN THE SCREWS

## CARENABRÍS UNIVERSAL MODELO / UNIVERSAL WINDSHIELD MODEL / UNIVERSAL WINDSCHUTZSCHEIBE MODEL

# UP & DOWN

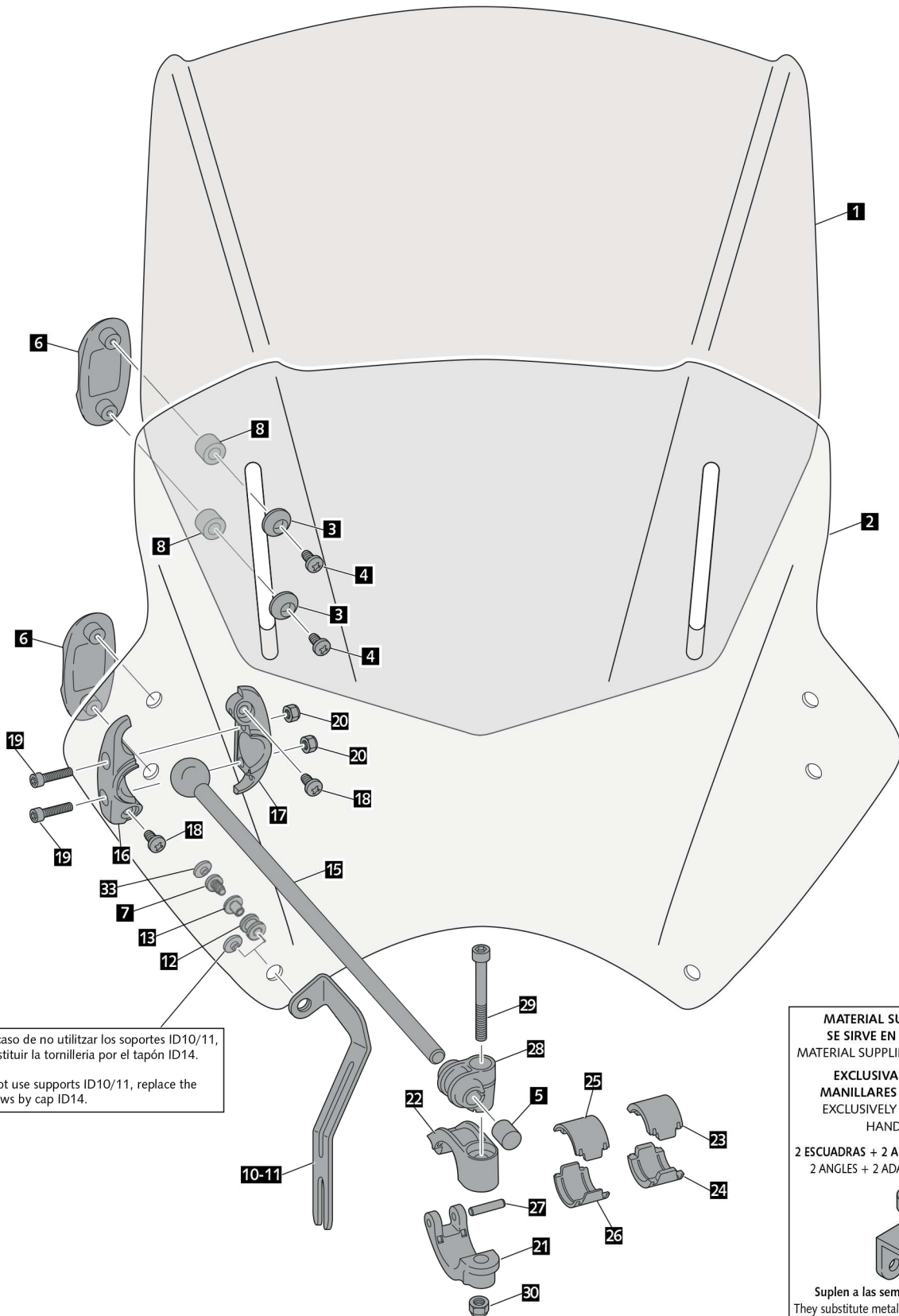

**14** En caso de no utilizar los soportes ID10/11, substituir la tornillería por el tapón ID14.  
 If not use supports ID10/11, replace the screws by cap ID14.

**MATERIAL SUMINISTRADO. SE SIRVE EN BOLSA ÚNICA**  
 MATERIAL SUPPLIED IN A SINGLE BAG























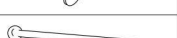







**EXCLUSIVAMENTE PARA MANILLARES DE FUNDICIÓN**  
 EXCLUSIVELY FOR FOUNDRY HANDLEBARS

**2 ESCUADRAS + 2 ADAPTADOR BRIDA-ESC.**  
 2 ANGLES + 2 ADAPTER BRIDLE-ANGLE

Suplen a las semi-bridles nº 21 y 22  
 They substitute metal semi-bridles nº 21 & 22

## CARENABRÍS UNIVERSAL MODELO / UNIVERSAL WINDSHIELD MODEL / UNIVERSAL WINDSCHUTZSCHEIBE MODEL

# UP & DOWN

ID	PIEZA / PART	DESCRIPCIÓN	DESCRIPTION	QTY	REF.
1		Pantalla superior	Higher windshield	1	2193H/WM3
2		Pantalla inferior	Lower windshield	1	2193H/WM3
3		Arandela cónica de plástico Ø20 Ø6	Ø20 Ø6 plastic conical washer	4	ARANENND20-030
4		Tornillo Ø4,5 x 25 DIN7505A Negro	Ø4,5 x 25 DIN7505A screw (black)	4	TORNI-D7505-778
5		Tope de plástico	Plastic cover	2	TOPEE-VPGT--8/4
6		Soporte de plástico	Plastic washer with sticker	4	CONJU-S3PCC-003
7		Tornillo Allen M5 x 11 Ø11 ISO 7380	M5x11 Ø11 ISO 7380 Allen Screw	2	TORNI-AI----520
8		Distanciador Nylon negro Ø20 x Ø10,5 x 15	Ø20 x Ø10,5 x 15 separator	4	ARAND-----779
10		Soporte derecho	Right support	1	SOPOR-2P-3-UP&D
11		Soporte izquierdo	Left support	1	SOPOR-2P-3-UP&D
12		Silentlock M5 Ø12 x Ø6 x 9	M5 Ø12 x Ø6 x 9 silentblock	2	AROPASACABLES-1
13		Casquillo con valona Ø12 x Ø6,8 x 7,3	Ø12 x Ø6,8 x 7,3 arrowhead	2	CASQUI-1A---750
14		Tapón paralelo	Parallel cap	2	TAPON-----780
15		Varilla recta Ø9	Ø9 Straight bar	2	CIROTULA-0-P200
16		Brida rótula L	L ball bearing bridle	2	BRIROT01-1-PR16
17		Brida rótula R	R ball bearing bridle	2	BRIROT02-1-PR16
18		Tornillo Philips Ø5x10mm	Ø5x10mm Philips screw	4	TORNIP510---233
19		Tornillo Allen M5x20 inox DIN912	M5x20 DIN912 Allen screw	4	TORNI-D912--748
20		Tuerca autoblocante M5 DIN982 INOX	M5 DIN982 self-locking nut	4	TUERCA-D982-746
21		Semi-bridla corta	Short semi-bridle	2	BRIDAANT-0-PR16
22		Semi-bridla larga	Large semi.-bridle	2	BRIDAPOS-0-PR16
23		Casquillo semi-bridla larga para manillar de Ø22	Large semi.-bridle arrowhead - handlebar Ø22	2	CAS29-22-0-PR16
24		Casquillo semi-bridla corta para manillar de Ø22	Short semi.-bridle arrowhead - handlebar Ø22	2	CAS29-22-0-PR16
25		Casquillo semi-bridla larga para manillar de Ø26	Large semi.-bridle arrowhead - handlebar Ø26	2	CAS29-26-0-PR16
26		Casquillo semi-bridla corta para manillar de Ø26	Short semi.-bridle arrowhead - handlebar Ø26	2	CAS29-26-0-PR16
27		Pasador cilíndrico Ø4x20mm	Ø4x20mm cross dowel pin	2	VARIL4X20--576
28		Brida varilla	Dispstick bridle	2	FIXVARLL-0-PR16
29		Tornillo Allen M8x55 DIN912	M8x55 DIN912 Allen screw	2	TORNI-D912--631
30		Tuerca M8 autoblocante	M8 self-locking nut	2	TUEA-D985.8-M8-
31		Escuadra	Angle	2	SOPORT30X30-581
32		Adaptador brida-esquadra	Adapter bridle - angle	2	FIXSOPOR-0-PR16
33		Tapón tornillo M5 ISO7380	M5 ISO7380 screw cap	2	TAPON-----85