

# HONDA REBEL 300/500 '17-/ S '20-

## M O U N T I N G I N S T R U C T I O N S

REF 3829

WINDSHIELD NG SPORT



ALLEN









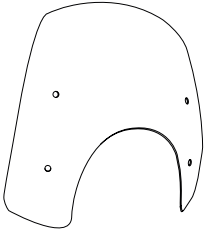

Nº 3  
Nº 6  
Nº 8

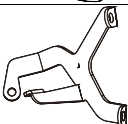

**ONLY FOR REBEL "S":**

**BEFORE INSTALLING THE PUIG PRODUCT,  
TAKE APART THE OEM SEMI-FAIRING**

**ANTES DE INSTALAR EL PRODUCTO PUIG,  
DESMONTAR EL SEMI-FARO ORIGINAL**

ID	PIEZA/PART	DESCRIPCIÓN	DESCRIPTION	QTY	REF
1		Cúpula Sport	Sport screen	1	3829 F/H/W/NM3
2		Soporte derecho ( R )	Right support ( R )	1	SOPOR2P6-R-9462
3		Soporte izquierdo ( L )	Left support ( L )	1	SOPOR2P6-L-9462
4		Tornillo Allen M8x45 ISO 7380	M8x45 ISO 7380 Allen screw	2	TORNI-I7380-817
5		Casquillo Ø8xØ14 x10	Ø8xØ14 x10 Arrowhead	2	CASQUI-----576
6		Silentblock M5	M5 silentblock	4	SILENBTM5-046/1
7		Arandela de nylon M5x1	M5x1 nylon washer	4	ARNV00000000245
8		Tornillo Allen M5x16 Ø11 ISO7380	M5x16 Ø11 ISO7380 Allen screw	4	TORNI-I7380-493
9		Tapón tornillo M5 ISO 7380	M5 ISO 7380 screw cap	4	TAPON-----85
10		Silentblock Ø12xØ6x9	Ø12xØ6x9 Silentblock	2	AROPASACABLES-1

# HONDA REBEL 300/500 '17- / S '20-

INSTRUCCIONES DE MONTAJE - MOUNTING INSTRUCTIONS - MONTAGEANLEITUNG

**1**

**DISASSEMBLY  
DESMONTAJE**

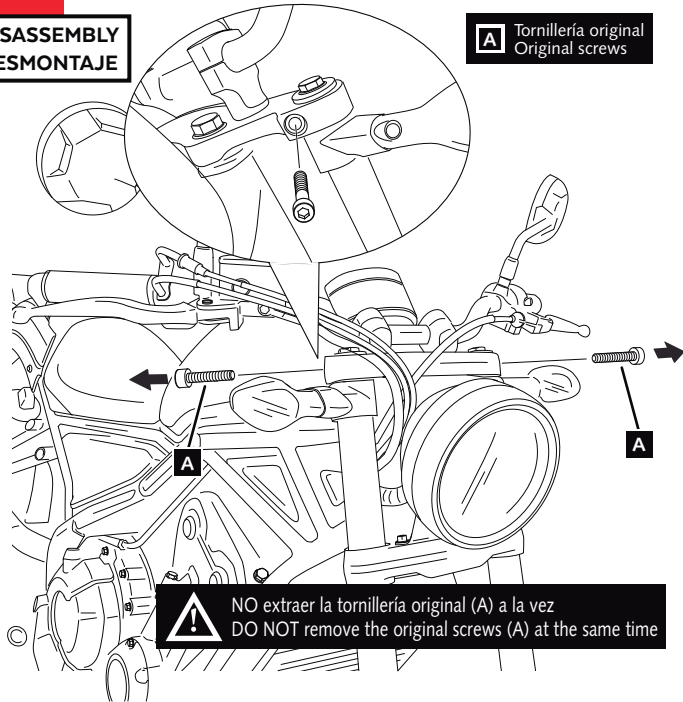

**A** Tornillería original  
Original screws

**!** NO extraer la tornillería original (A) a la vez  
DO NOT remove the original screws (A) at the same time

**2**

**ASSEMBLY  
MONTAJE**

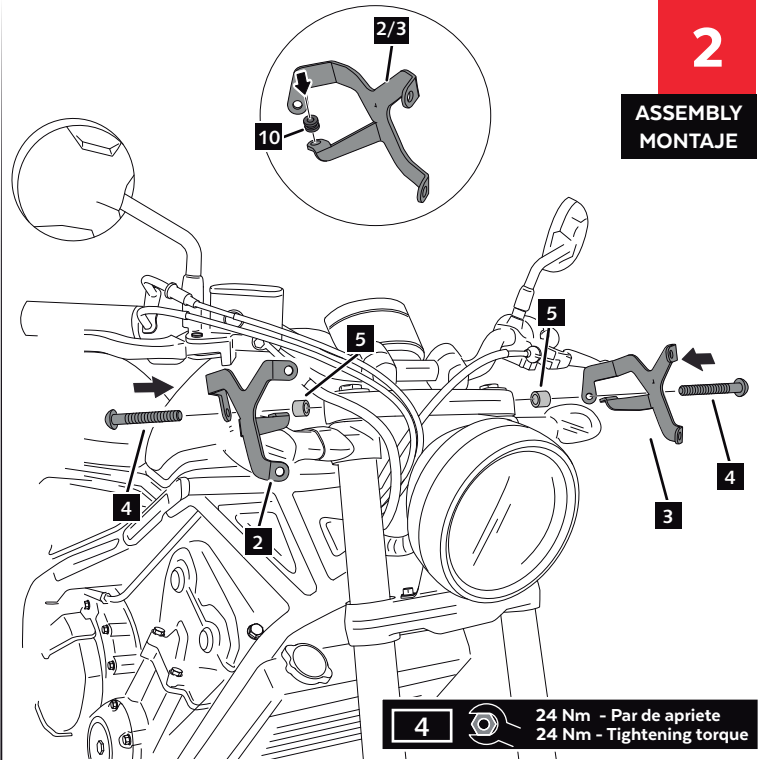

**4** 24 Nm - Par de apriete  
24 Nm - Tightening torque

**3**

**ASSEMBLY  
MONTAJE**

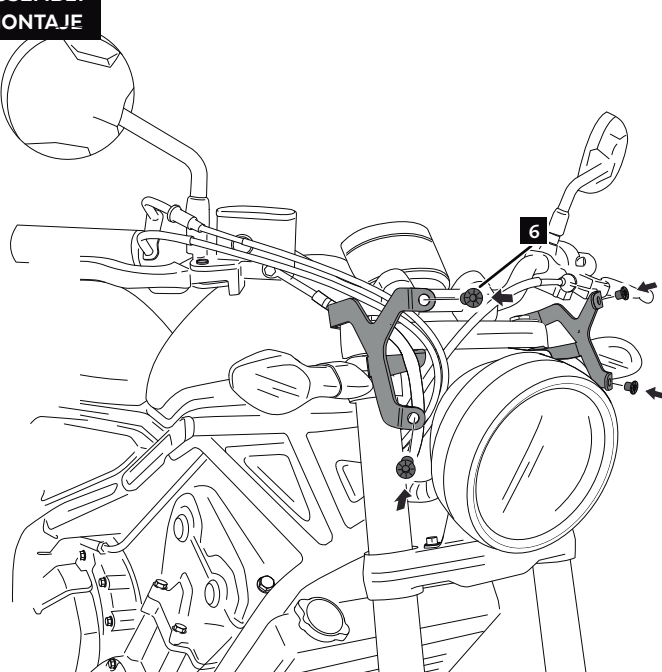

**4**

**ASSEMBLY  
MONTAJE**

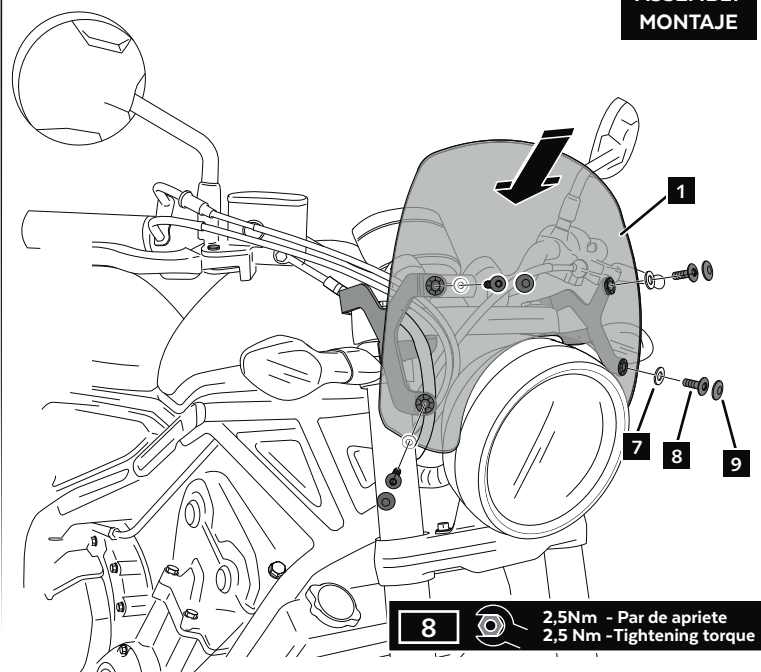

**8** 2,5Nm - Par de apriete  
2,5 Nm - Tightening torque